



# ***Procedure for checking over-voltage damage.***

*Published December 22, 2015*

# Contents

---

<b>Checking procedure for over-voltage damage</b> .....	<b>7</b>
1. Check Schottky diode measurement with multimeter in diode mode;.....	7
2. Check voltage drop between diode array pin#1 and Ground.....	8
3. Check termination resistors resistance in RJ-45 connector.....	9
<b>RB2011 series RouterBoards</b> .....	<b>10</b>
List of RB2011 series RouterBoards:.....	10
Disassembling information.....	11
Schottky diode measuring with multimeter in diode mode.....	13
Voltage drop between diode array pin#1 and Ground.....	13
Termination resistors resistance in RJ-45 connector.....	14
<b>Cloud Core Router CCR1009 series RouterBoards</b> .....	<b>15</b>
List of CCR1009 series RouterBoards:.....	15
Disassembling information.....	16
Schottky diode measuring with multimeter in diode mode.....	19
Voltage drop between diode array pin#1 and Ground.....	19
Termination resistors resistance in RJ-45 connector.....	20
<b>Cloud Core Router CCR1016-12G, CCR1036-12G series</b> .....	<b>22</b>
List of Cloud Core Router CCR1016-12G, CCR1036-12G series:.....	22
Disassembling information.....	23
Voltage drop between diode array pin#1 and Ground.....	24
Termination resistors resistance in RJ-45 connector.....	25
<b>Cloud Core Router CCR1036-8G-2S+ series</b> .....	<b>26</b>
List of Cloud Core Router CCR1036-8G-2S+ series:.....	26
Disassembling information.....	27
Voltage drop between diode array pin#1 and Ground.....	29
<b>Cloud Core Router CCR1072-1G-8S+ series</b> .....	<b>31</b>
Cloud Core Router CCR1072-1G-8S+:.....	31
Disassembling information.....	31
Voltage drop between diode array pin#1 and Ground.....	32
Termination resistors resistance in RJ-45 connector.....	33
<b>RB750r2 series RouterBoards</b> .....	<b>34</b>
List of RB750r2 series:.....	34
Disassembling information.....	40
Schottky diode measuring with multimeter in diode mode.....	42
Voltage drop between diode array pin#1 and Ground.....	42
75R termination resistors resistance.....	43
<b>RB922GS-5HPac series RouterBoards</b> .....	<b>44</b>
RB922GS-5HPac series:.....	44
Disassembling information.....	48
Schottky diode measuring with multimeter in diode mode.....	56
Voltage drop between diode array pin#1 and Ground.....	57

<b>RB921UAGS-5SHPac series RouterBoards.....</b>	<b>60</b>
RB921GS-5HPac series:.....	60
Disassembling information.....	62
Schottky diode measuring with multimeter in diode mode.....	68
Voltage drop between diode array pin#1 and Ground.....	69
<b>RBmAP series RouterBoards.....</b>	<b>70</b>
RBmAP series:.....	70
Disassembling information.....	72
Schottky diode measuring with multimeter in diode mode.....	76
Voltage drop between diode array pin#1 and Ground.....	79
<b>RBcAP series RouterBoards.....</b>	<b>81</b>
RBcAP series:.....	81
Disassembling information.....	82
Schottky diode measuring with multimeter in diode mode.....	83
Voltage drop between diode array pin#1 and Ground.....	84
75R Termination resistors resistance.....	87
<b>RBDynaDish series RouterBoards.....</b>	<b>89</b>
RBDynaDish series:.....	89
Disassembling information.....	91
Schottky diode measuring with multimeter in diode mode.....	92
.....	95
Voltage drop between diode array pin#1 and Ground.....	96
<b>RB953GS-5HnT series RouterBoards.....</b>	<b>98</b>
Schottky diode measuring with multimeter in diode mode.....	100
.....	101
Voltage drop between diode array pin#1 and Ground.....	102
75R Termination resistors resistance.....	104
<b>RB850Gx2 series RouterBoards.....</b>	<b>106</b>
Schottky diode measuring with multimeter in diode mode.....	107
Voltage drop between diode array pin#1 and Ground.....	108
75R Termination resistors resistance.....	109
<b>RB912G - 2HnD series RouterBoards.....</b>	<b>111</b>
BaseBox 2 disassembling information.....	114
Schottky diode measuring with multimeter in diode mode.....	116
Voltage drop between diode array pin#1 and Ground.....	117
75R Termination resistors resistance.....	118
<b>RB912G - 5HPnD series RouterBoards.....</b>	<b>121</b>
QRT 5 disassembling information.....	125
Schottky diode measuring with multimeter in diode mode.....	130
Voltage drop between diode array pin#1 and Ground.....	131
75R Termination resistors resistance.....	135
<b>RBSXTG-5HPacD series RouterBoards.....</b>	<b>136</b>
RBSXTG-5HPacD series:.....	136

Disassembling information.....	137
Schottky diode measuring with multimeter in diode mode.....	141
Voltage drop between diode array pin#1 and Ground.....	142
<b>RBSXTLite2 series RouterBoards.....</b>	<b>144</b>
RBSXTLite2 series:.....	144
Disassembling information.....	145
Schottky diode measuring with multimeter in diode mode.....	150
Voltage drop between diode array pin#1 and Ground.....	152
75R Termination resistors resistance.....	154
<b>RBSXTLite5 series RouterBoards.....</b>	<b>156</b>
RBSXTLite5 series:.....	156
Disassembling information.....	157
Schottky diode measuring with multimeter in diode mode.....	160
Voltage drop between diode array pin#1 and Ground.....	161
75R Termination resistors resistance.....	163
<b>RBSXTG-5HPnD series RouterBoards.....</b>	<b>164</b>
RBSXTG-5HPnD series:.....	164
Disassembling information.....	166
Schottky diode measuring with multimeter in diode mode.....	169
Voltage drop between diode array pin#1 and Ground.....	171
75R Termination resistors resistance.....	172
<b>hAP lite series RouterBoards.....</b>	<b>173</b>
1.Disassembling information.....	174
Voltage drop between Ethernet signal lines and Ground.....	179
<b>RB951G-2HnD series RouterBoards.....</b>	<b>180</b>
Disassembling information.....	181
Schottky diode measuring with multimeter in diode mode.....	182
Voltage drop between diode array pin#1 and Ground.....	182
75R termination resistors resistance.....	185
<b>RB951Ui-2HnD series RouterBoards.....</b>	<b>187</b>
Disassembling information.....	188
Schottky diode measuring with multimeter in diode mode.....	189
Voltage drop between diode array pin#1 and Ground.....	189
75R termination resistors resistance.....	190
<b>RB751U-2HnD series RouterBoards.....</b>	<b>192</b>
Disassembling information.....	193
Schottky diode measuring with multimeter in diode mode.....	194
Voltage drop between diode array pin#1 and Ground.....	194
75R termination resistors resistance.....	195
<b>RB951-2n series RouterBoards.....</b>	<b>196</b>
Disassembling information.....	197
Schottky diode measuring with multimeter in diode mode.....	198
Voltage drop between diode array pin#1 and Ground.....	198

75R termination resistors resistance.....	199
<b>CRS112-8G-4S series RouterBoards.....</b>	<b>200</b>
Disassembling information.....	200
Schottky diode measuring with multimeter in diode mode.....	202
Voltage drop between diode array pin#1 and Ground.....	202
75R termination resistors resistance.....	203
<b>CRS210-8G-2S+ series RouterBoards.....</b>	<b>204</b>
Disassembling information.....	204
Schottky diode measuring with multimeter in diode mode.....	206
Voltage drop between diode array pin#1 and Ground.....	206
<b>CRS212-1G-10S-1S+ series RouterBoards.....</b>	<b>207</b>
Disassembling information.....	207
Schottky diode measuring with multimeter in diode mode.....	209
Voltage drop between diode array pin#1 and Ground.....	209
75R termination resistors resistance.....	210
<b>CRS109-8G-4S series RouterBoards.....</b>	<b>211</b>
Disassembling information.....	212
Schottky diode measuring with multimeter in diode mode.....	213
Voltage drop between diode array pin#1 and Ground.....	213
75R termination resistors resistance.....	214
<b>CRS226-24G-2S+ series RouterBoards.....</b>	<b>215</b>
Disassembling information.....	216
Schottky diode measuring with multimeter in diode mode.....	217
Voltage drop between diode array pin#1 and Ground.....	217
75R termination resistors resistance.....	218
<b>CRS125-24G-1S series.....</b>	<b>219</b>
List of Cloud Router Switch CRS125-24G-1S series:.....	219
Disassembling information.....	220
Schottky diode measuring with multimeter in diode mode.....	222
Voltage drop between diode array pin#1 and Ground.....	222
Termination resistors resistance in RJ-45 connector.....	223
<b>RB911-2Hn series RouterBoards.....</b>	<b>224</b>
Schottky diode measuring with multimeter in diode mode.....	225
Voltage drop between diode array pin#1 and Ground.....	225
75R termination resistors resistance.....	226
<b>RB911-5Hn series RouterBoards.....</b>	<b>227</b>
Schottky diode measuring with multimeter in diode mode.....	228
Voltage drop between diode array pin#1 and Ground.....	228
75R termination resistors resistance.....	229
<b>RBFTC11 series RouterBoards.....</b>	<b>230</b>
Schottky diode measuring with multimeter in diode mode.....	232
Voltage drop between diode array pin#1 and Ground.....	232

<b>RBwAP series RouterBoards.....</b>	<b>233</b>
Schottky diode measuring with multimeter in diode mode.....	235
Voltage drop between diode array pin#1 and Ground.....	235
<b>RB260GSP series RouterBoards.....</b>	<b>236</b>
Disassembling information.....	237
Schottky diode measuring with multimeter in diode mode.....	238
Voltage drop between diode array pin#1 and Ground.....	238
<b>RBMetal 5SHPn series RouterBoards.....</b>	<b>239</b>
Schottky diode measuring with multimeter in diode mode.....	241
Voltage drop between diode array pin#1 and Ground.....	241
<b>RBMetal 2SHPn series RouterBoards.....</b>	<b>242</b>
Schottky diode measuring with multimeter in diode mode.....	244
Voltage drop between diode array pin#1 and Ground.....	244
<b>RBMetal 9HPn series RouterBoards.....</b>	<b>245</b>
Schottky diode measuring with multimeter in diode mode.....	247
Voltage drop between diode array pin#1 and Ground.....	247
<b>RBGroove 52HPn series RouterBoards.....</b>	<b>248</b>
Voltage drop between diode array pin#1 and Ground.....	249
75R termination resistors resistance.....	249
<b>RBSXT LTE series RouterBoards.....</b>	<b>251</b>
RBSXT LTE series:.....	251
Disassembling information.....	252
Schottky diode measuring with multimeter in diode mode.....	254
Voltage drop between diode array pin#1 and Ground.....	255
75R Termination resistors resistance.....	256
<b>RB3011 series RouterBoards.....</b>	<b>257</b>
List of RB3011 series RouterBoards:.....	257
Disassembling information.....	257
Schottky diode measuring with multimeter in diode mode.....	258
Voltage drop between diode array pin#1 and Ground.....	258
Termination resistors resistance.....	259
<b>RBOmniTIK UPA-5HnD series RouterBoards.....</b>	<b>260</b>
Schottky diode measuring with multimeter in diode mode.....	262
Voltage drop between diode array pin#1 and Ground.....	263
75R Termination resistors resistance.....	263

## Checking procedure for over-voltage damage

Over-voltage can be caused by the following reasons: high voltage surge, lightning, electrostatics etc. You can check if routerboard was damaged by over-voltage, by using the following testing method:

### 1. Check Schottky diode measurement with multimeter in diode mode;

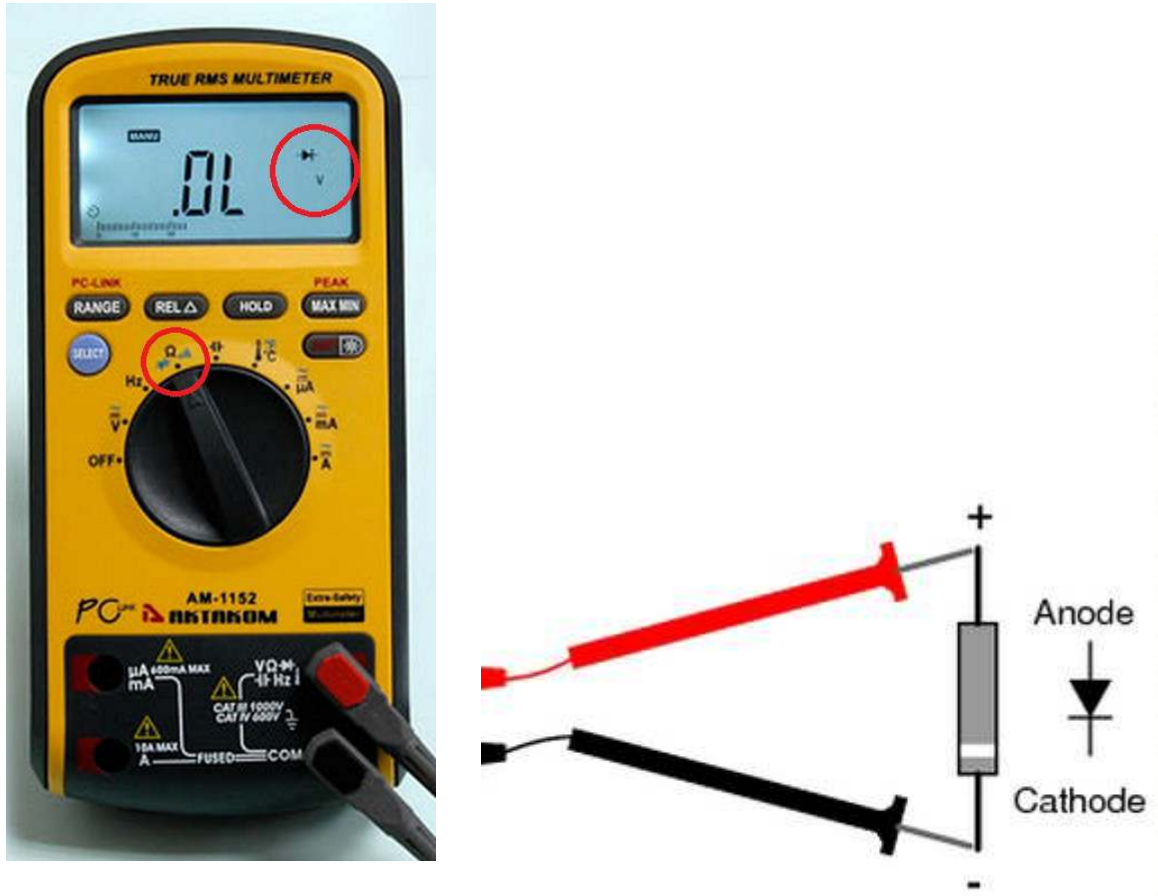

The multimeter usually has a diode test function:

When the test probes are connected as shown the meter gives you the diode voltage drop measurement.

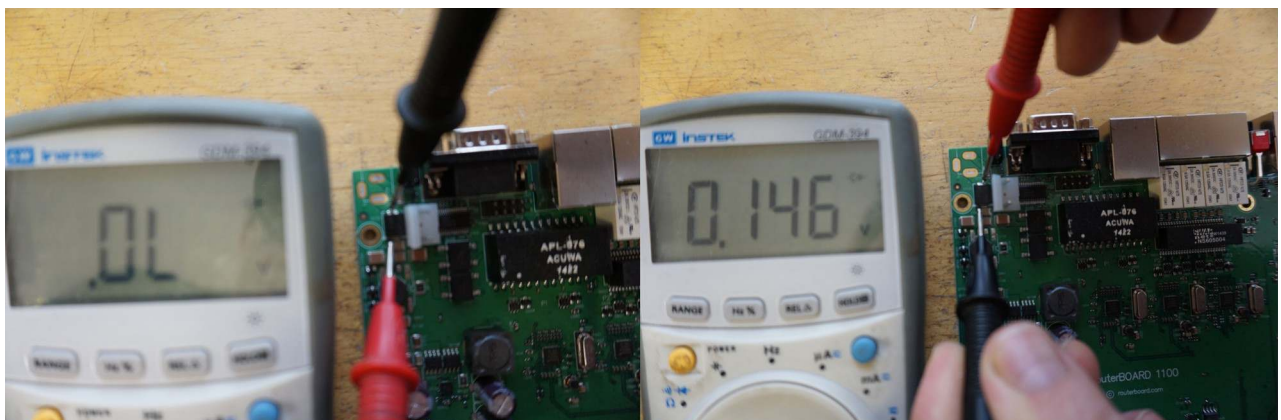

In the same manner we make Diode bridge test, considering schematic of bridge rectifiers

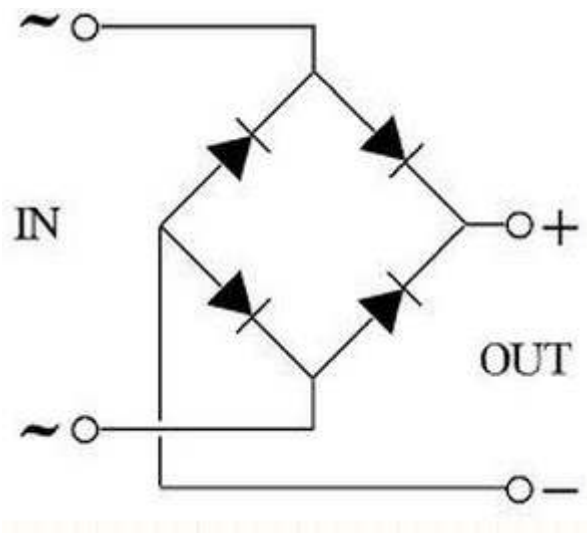

## 2. Check voltage drop between diode array pin#1 and Ground.

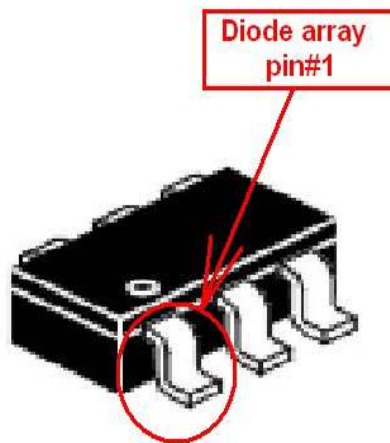

You should measure in diode mode (hold “positive” wire on the Ground and “COM” wire to diode array pin#1). Diode array pin#1 is always marked by dot mark on the diode array case (see picture 1 in the appendix).

Diode array reference number and voltage drop values could be found in the table 1;



### 3. Check termination resistors resistance in RJ-45 connector.

For this measurement you should take patch cord and plug it into the routerboard (see picture 2 in the appendix), and then measure resistance of termination resistors.



Resistance value between Rx and Tx line must be 150 Ohm  $\pm 4\%$ .

If resistance value is smaller or higher then Tx/Rx line was damaged by high voltage surge.

## RB2011 series RouterBoards

### List of RB2011 series RouterBoards:



## Disassembling information

### Indoor 2011 series RouterBoards

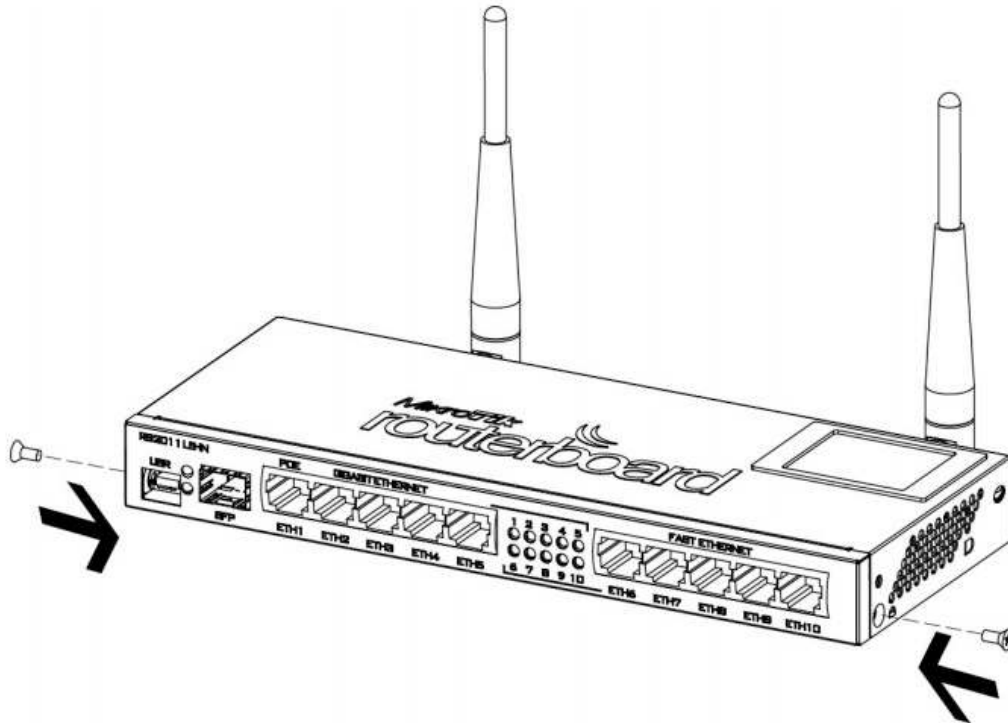

# Rackmount 2011 series RouterBoard

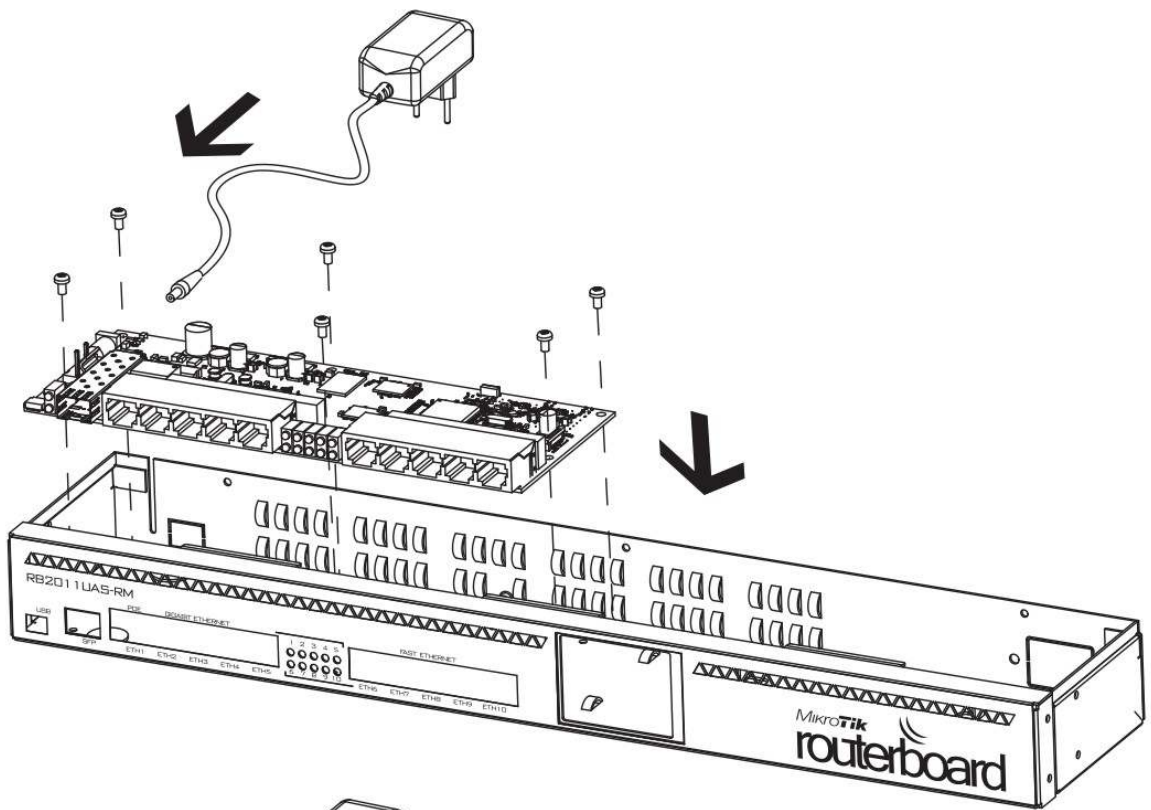
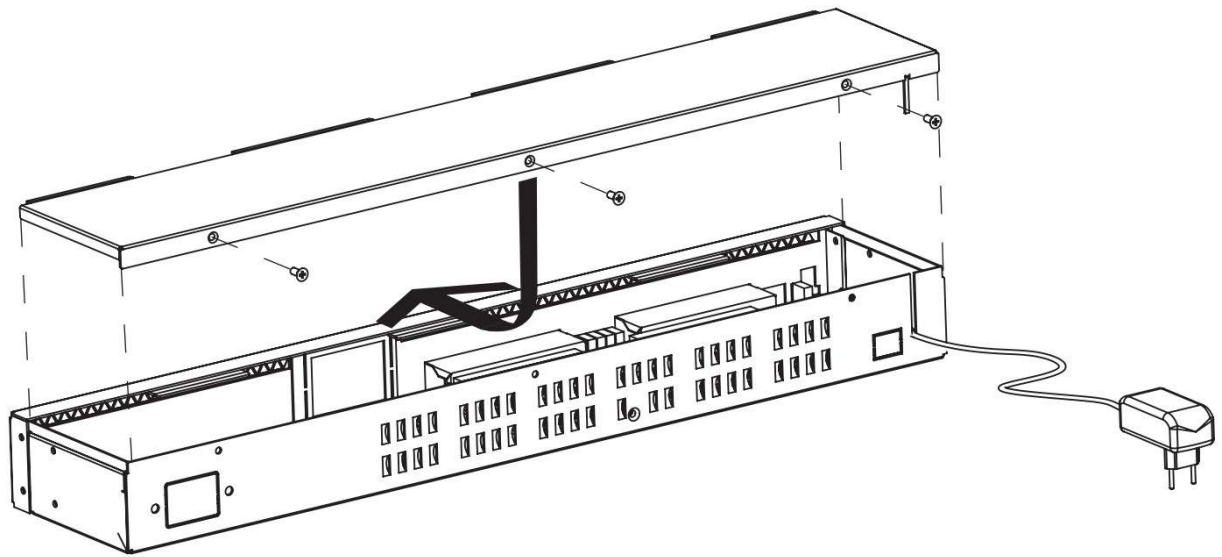

## Schottky diode measuring with multimeter in diode mode

Schottky diode reference numbers is D2; Voltage drop value should be about 0,197V  
Diode bridges reference numbers are D6, D4. Voltage drop value should be about 0,511V

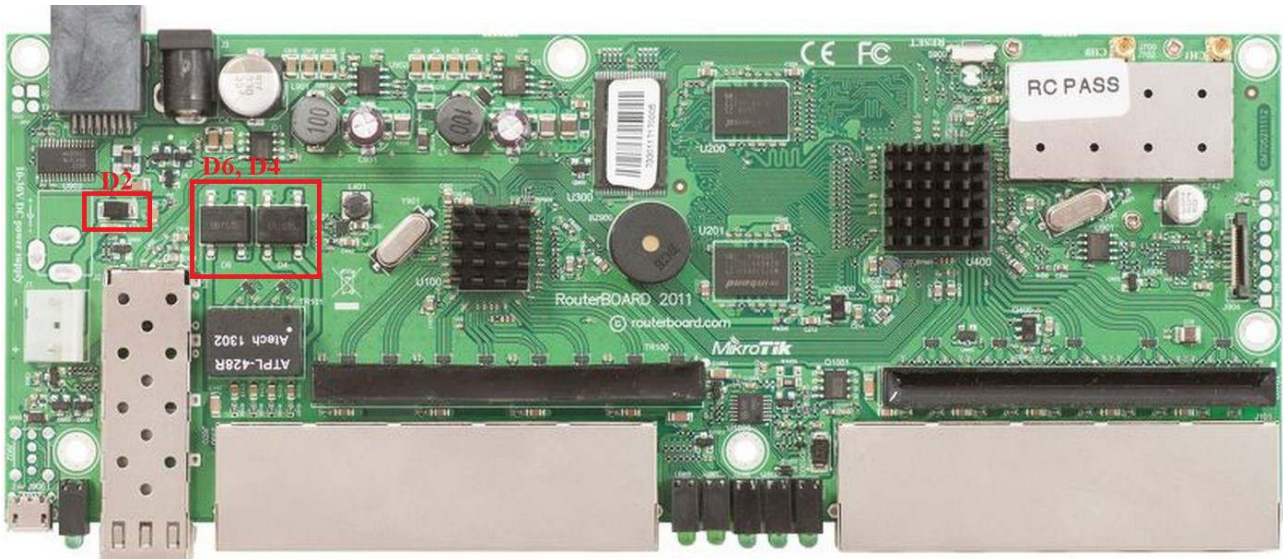

## Voltage drop between diode array pin#1 and Ground.

Check voltage drop between Transformer TR100, TR101 and TR102 pins and Ground.  
It should be in the range from 0,32V to 0,438V

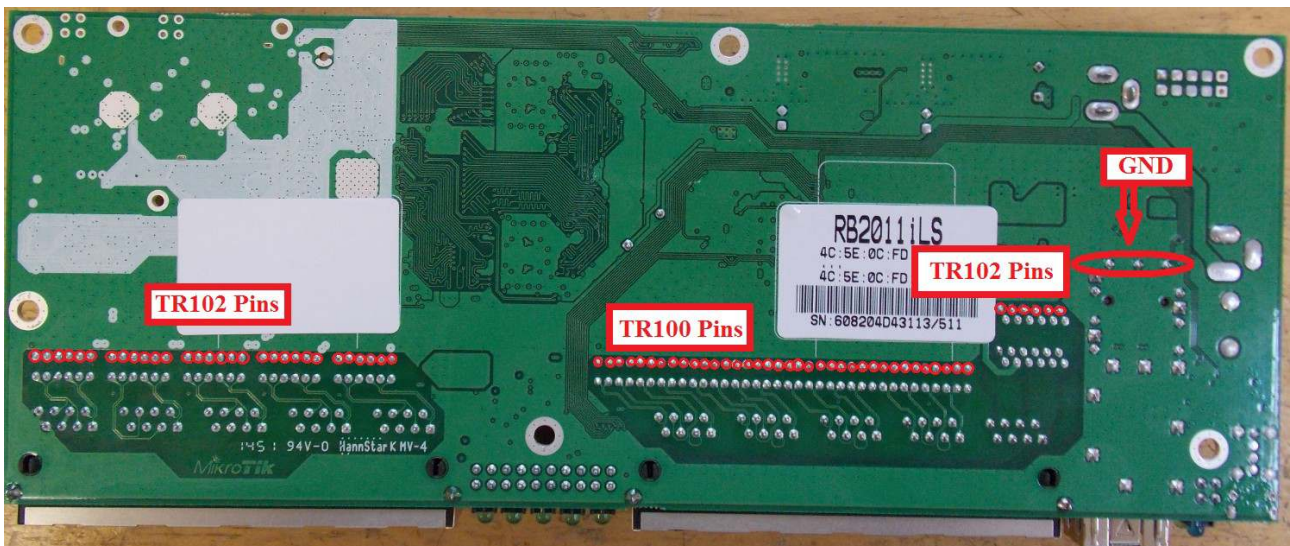

## Termination resistors resistance in RJ-45 connector

Red circled resistors resistance should be 75Ohm +/- 1%

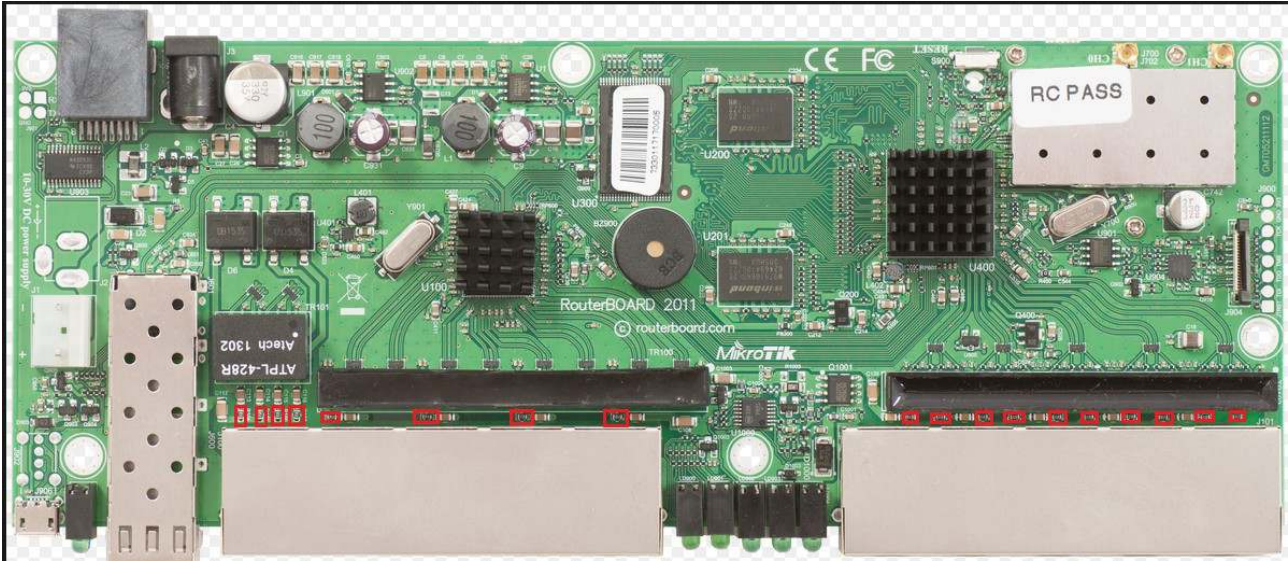

On ports Ether2 – Ether10 You can take patch cord and plug it into the routerboard, and then measure resistance of termination resistors.

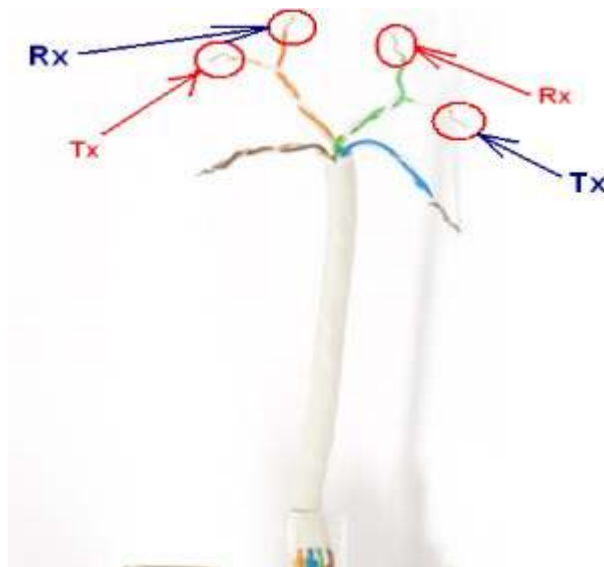

Resistance value between Rx and Tx line must be 150 Ohm +/-4%.

If resistance value is smaller or higher then Tx/Rx line was damaged by high voltage surge.

## Cloud Core Router CCR1009 series RouterBoards

### List of CCR1009 series RouterBoards:



**CCR1009-8G-1S-1S+PC**

## Disassembling information

CCR1009-8G-1S-1S+



1. Use PH2 screw driver to loose backside screws then side screws, take off cover. Detach DSUB-9 connector fasteners.





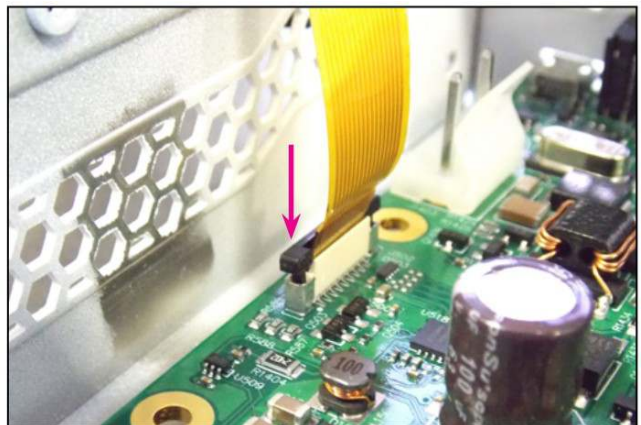
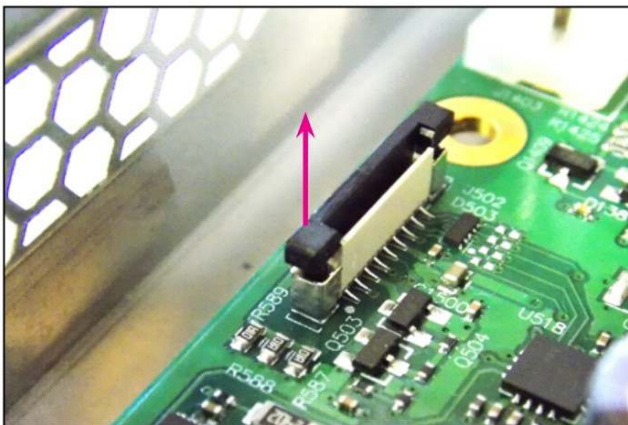
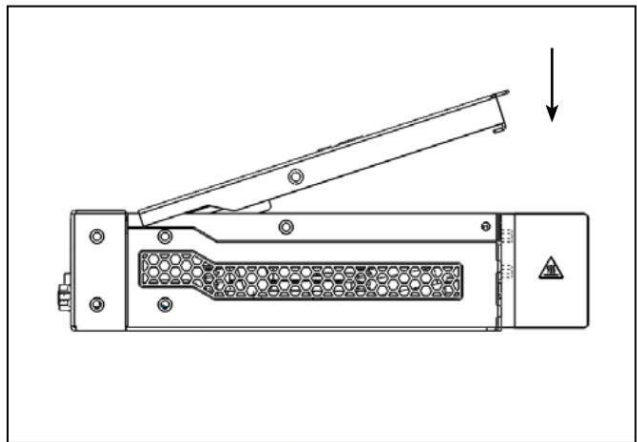
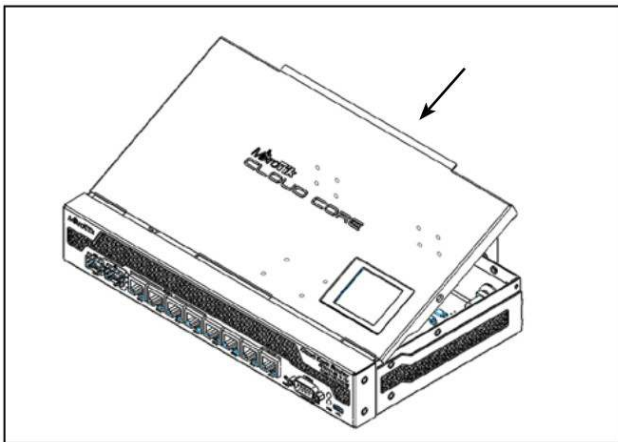
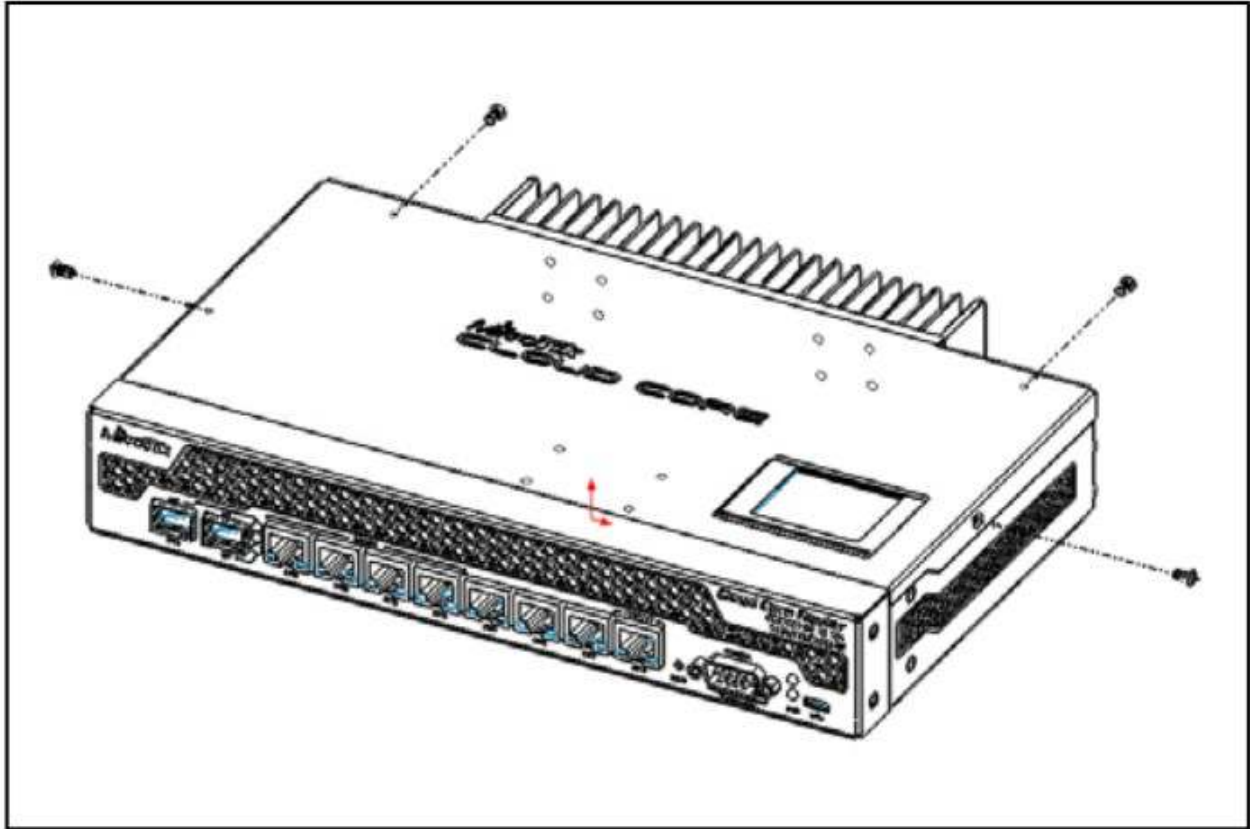

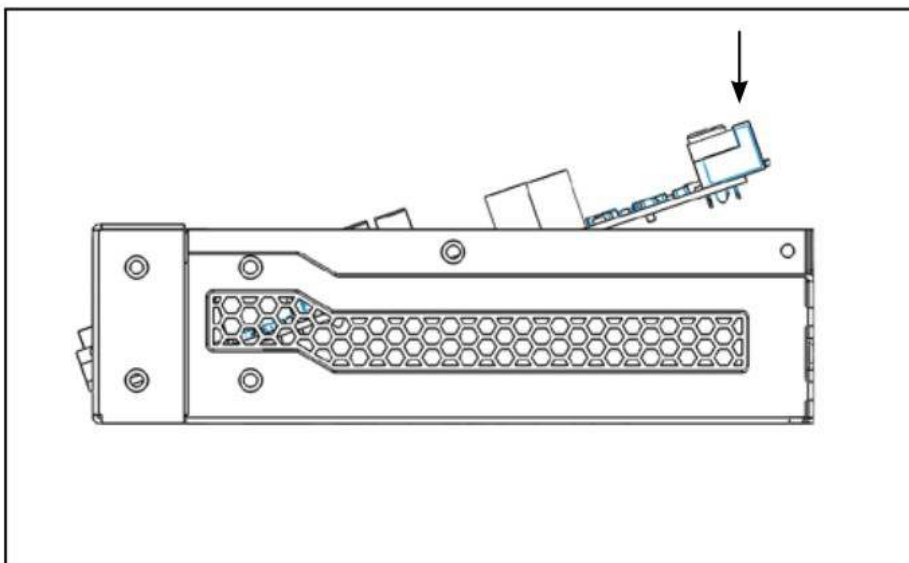
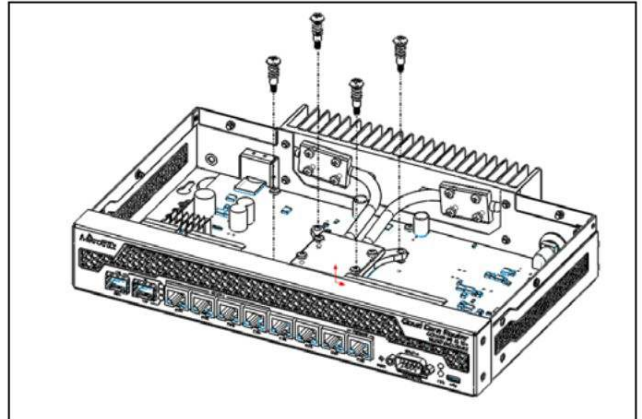
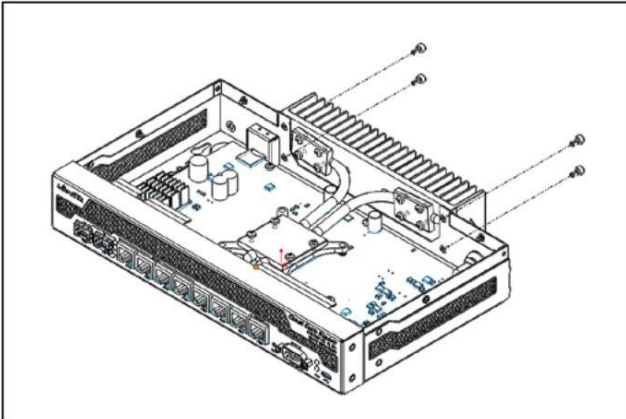
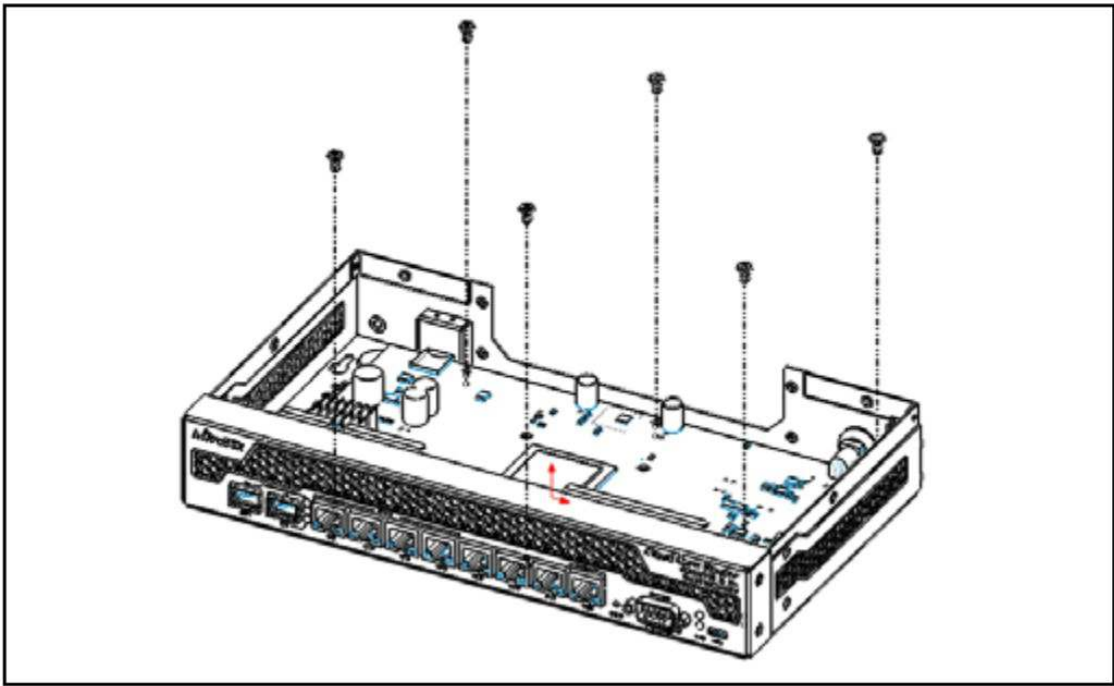

## Schottky diode measuring with multimeter in diode mode

Schottky diode reference numbers is D1401, D1402, D1403, D1405. Voltage drop value should be about 0,264V



## Voltage drop between diode array pin#1 and Ground.

Check voltage drop between internal Ethernet Transformers on ports Ether2 – Ether8 pins and Ground.

It should be in the range from 0,32V to 0,438V

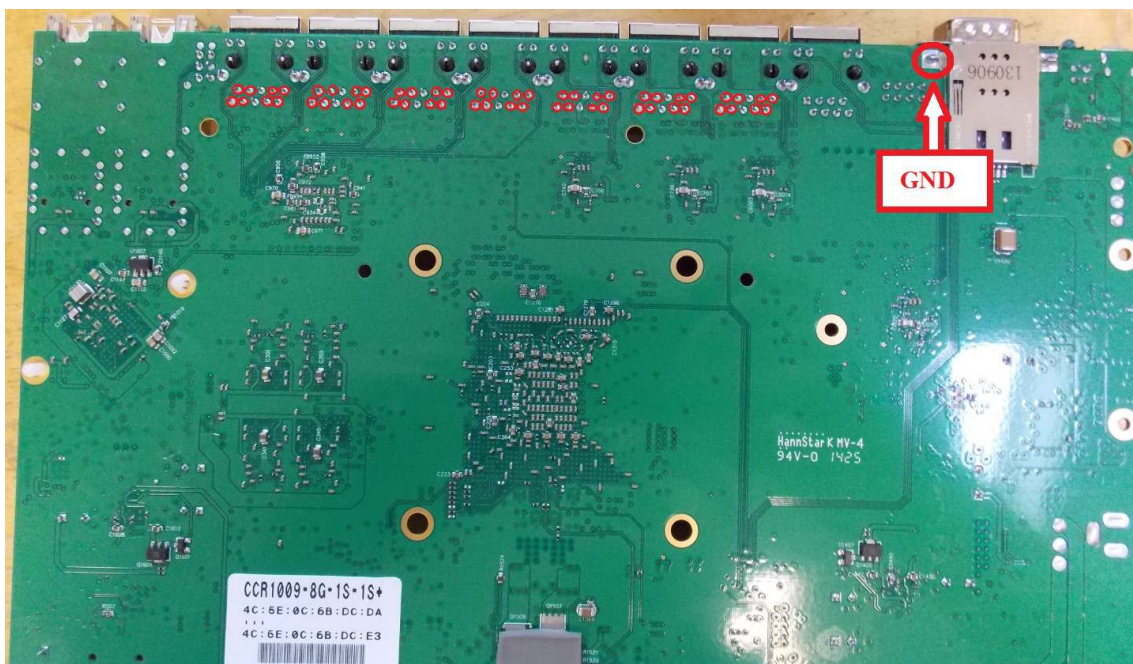

For Ether1 measure voltage drop on TR6 Pins and Ground. It should be in the range from 0,32V to 0,438V

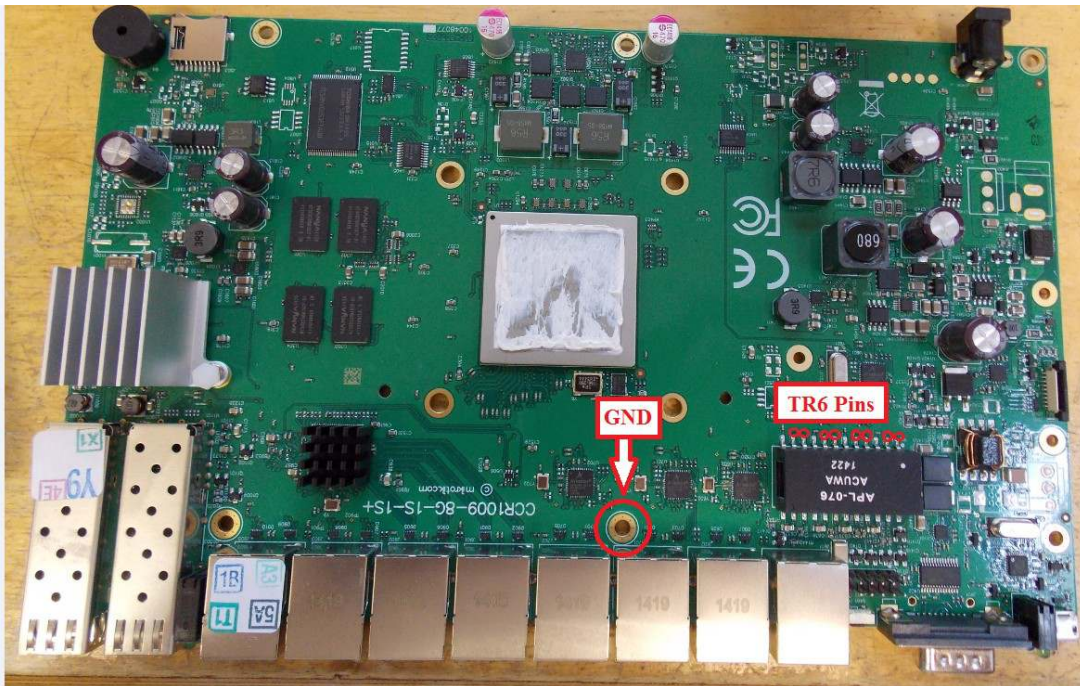

### Termination resistors resistance in RJ-45 connector

Red circled resistors resistance should be 75Ohm +/- 1%

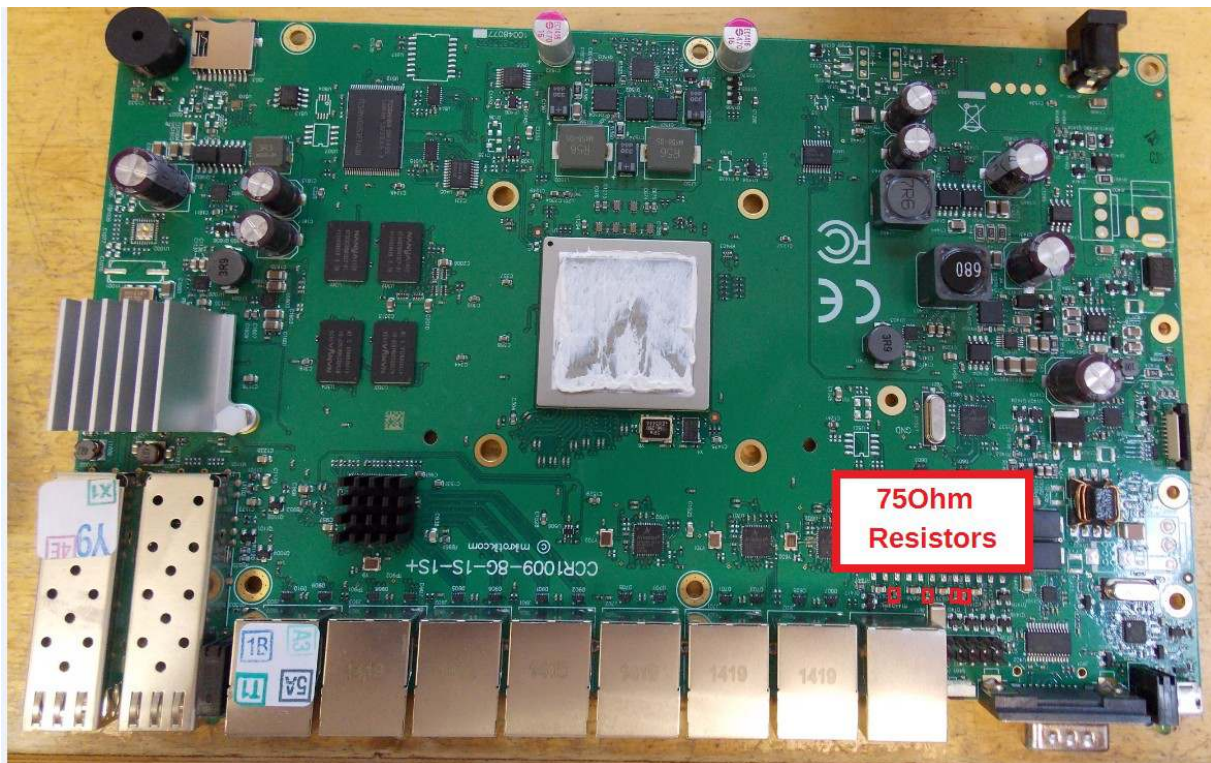

On ports Ether2 – Ether8 You can take patch cord and plug it into the routerboard, and then measure resistance of termination resistors.

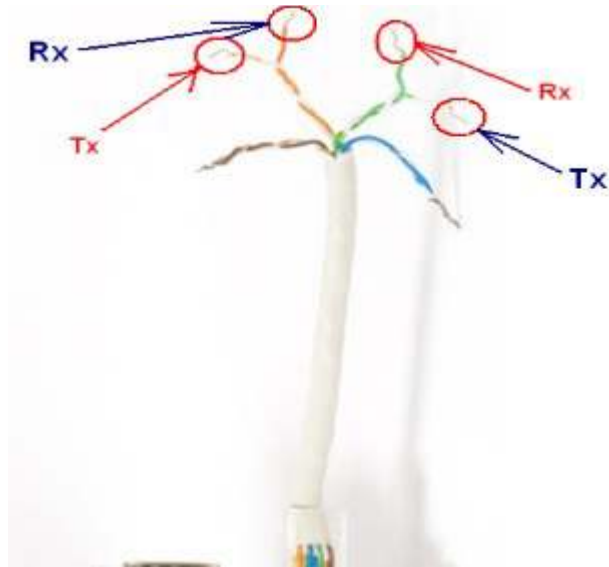

Resistance value between Rx and Tx lines must be 150 Ohm  $\pm 4\%$ .

If resistance value is smaller or higher then Tx/Rx line was damaged by high voltage surge.

## Cloud Core Router CCR1016-12G, CCR1036-12G series

---

List of Cloud Core Router CCR1016-12G, CCR1036-12G series:

CCR1016-12G



CCR1036-12G-4S

CCR1036-12G-4S-EM



## Disassembling information



## Voltage drop between diode array pin#1 and Ground.

Check voltage drop between diode arrays pin#1 and Ground. Diode arrays are circled red. It should be in the range from 0,32V to 0,438V

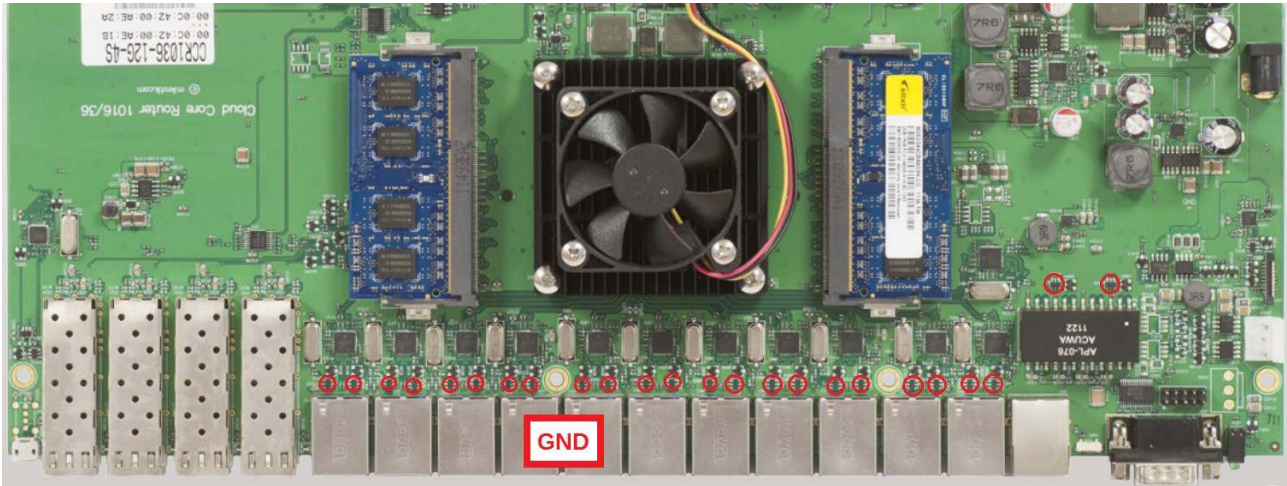



## Termination resistors resistance in RJ-45 connector

Red circled resistors resistance should be 75Ohm +/- 1%

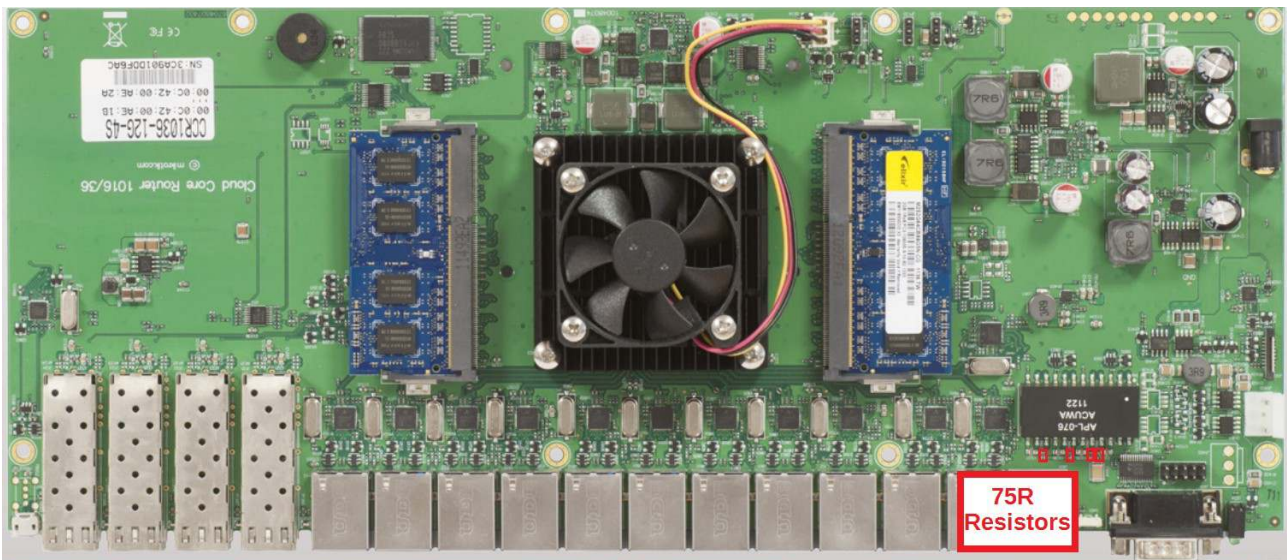

On ports Ether2 – Ether11 You can take patch cord and plug it into the routerboard, and then measure resistance of termination resistors.

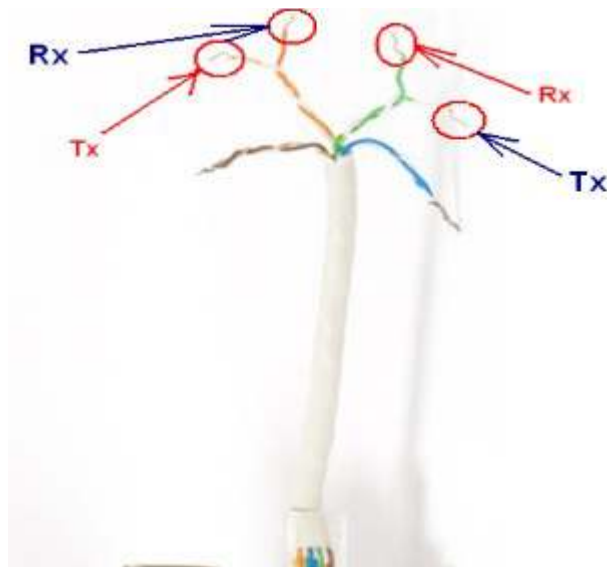

Resistance value between Rx and Tx lines must be 150 Ohm +/-4%.

If resistance value is smaller or higher then Tx/Rx line was damaged by high voltage surge.

## Cloud Core Router CCR1036-8G-2S+ series

---

List of Cloud Core Router CCR1036-8G-2S+ series:

**CCR1036-8G-2S+**

**CCR1036-8G-2S+EM**



## Disassembling information



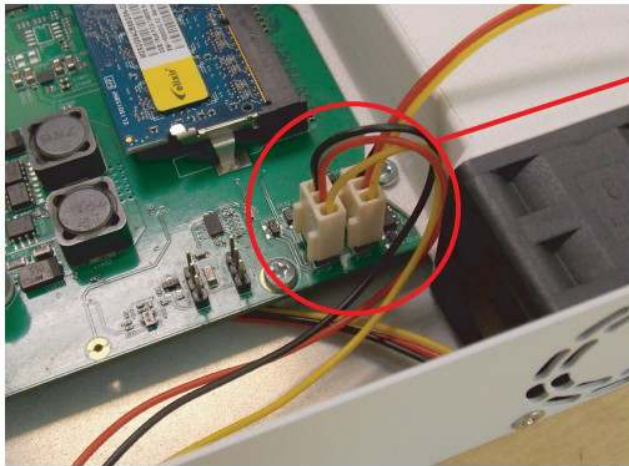
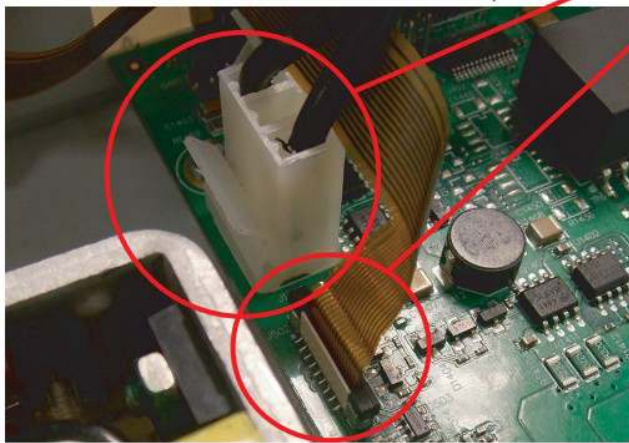
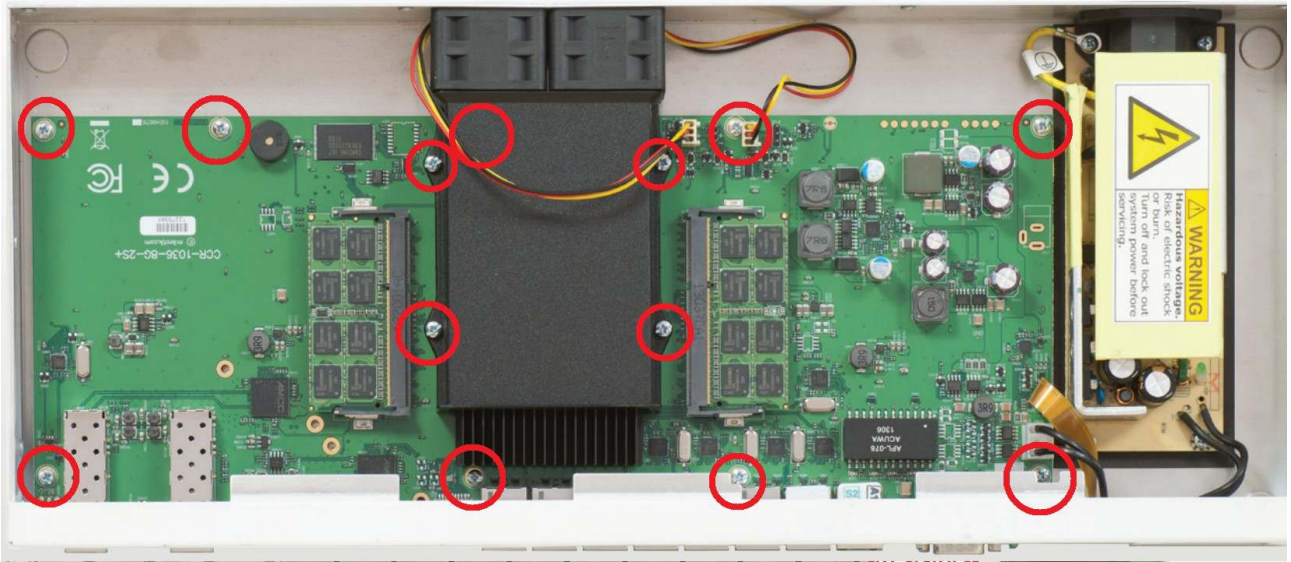

## Voltage drop between diode array pin#1 and Ground.

Check voltage drop between internal Ethernet Transformers on ports Ether1 – Ether7 pins and Ground. Ether Pins are circled red.

It should be in the range from 0,32V to 0,438V



## Cloud Core Router CCR1072-1G-8S+ series

---

Cloud Core Router CCR1072-1G-8S+:

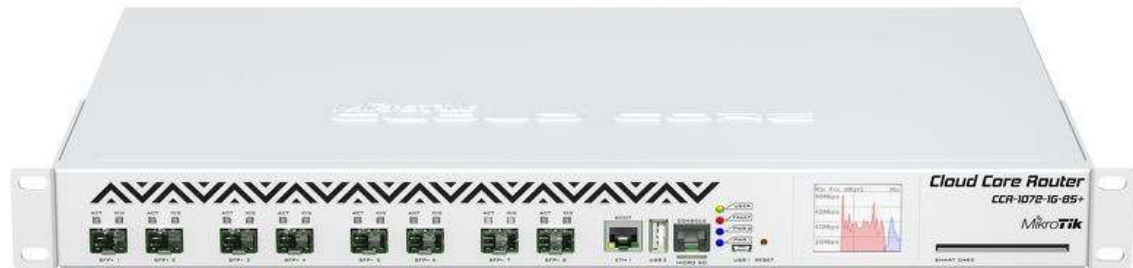

### Disassembling information

Unscrew 9 pcs screws with PH2 screwdriver and remove the board cover

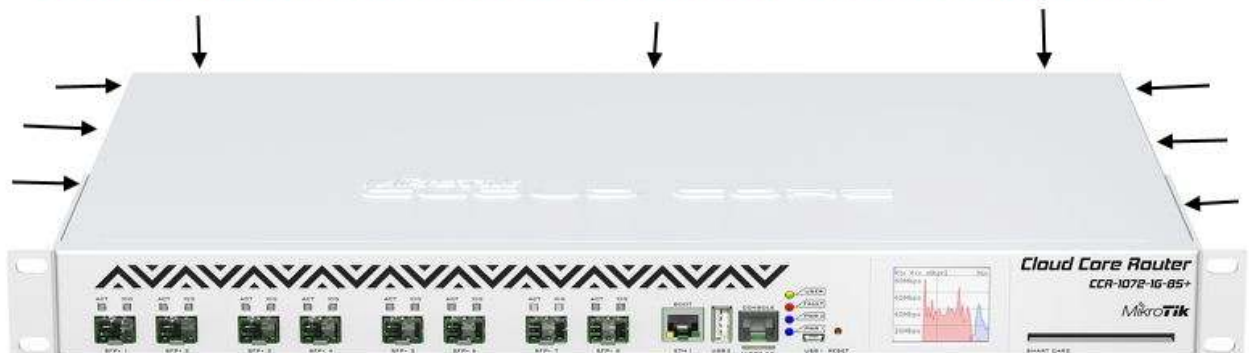

## Voltage drop between diode array pin#1 and Ground.

Check voltage drop between diode arrays pin#1 and Ground. Diode arrays pins are circled red. It should be in the range from 0,31V to 0,438V

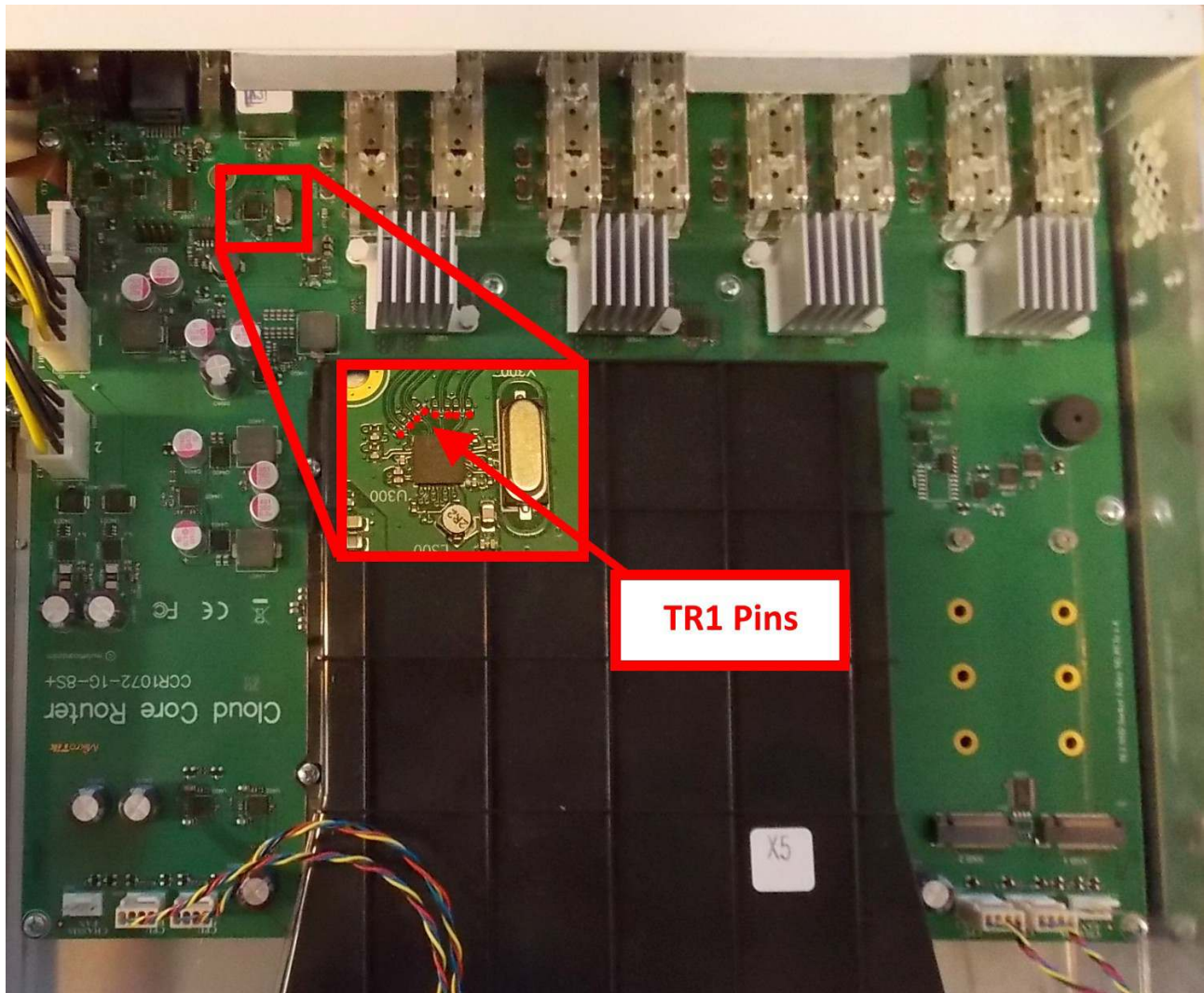

## Termination resistors resistance in RJ-45 connector

Red circled resistors resistance should be 75Ohm +/- 1%

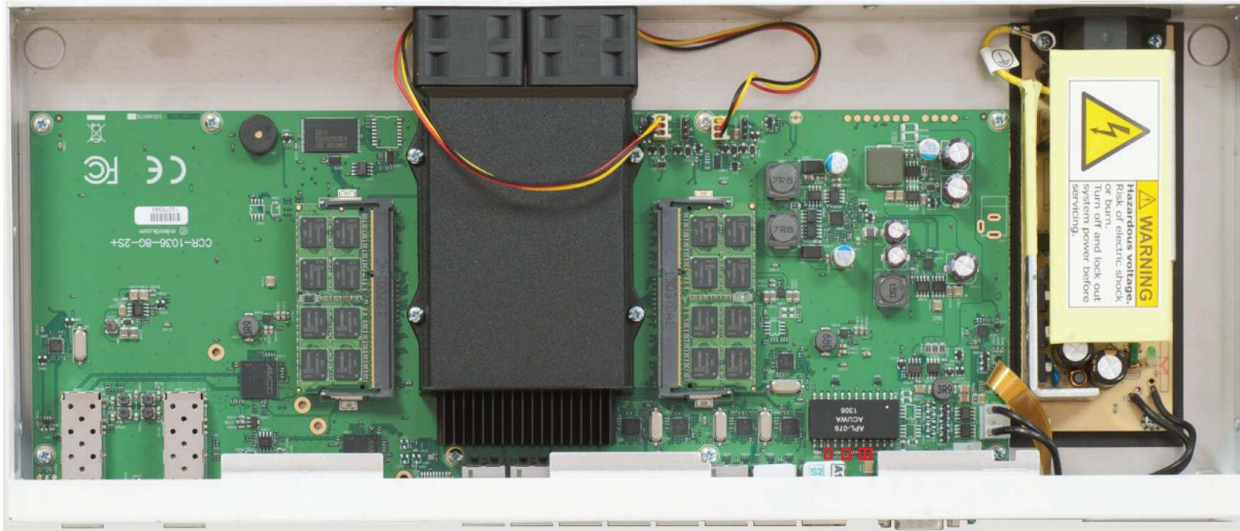

On ports Ether1 – Ether7 You can take patch cord and plug it into the routerboard, and then measure resistance of termination resistors.

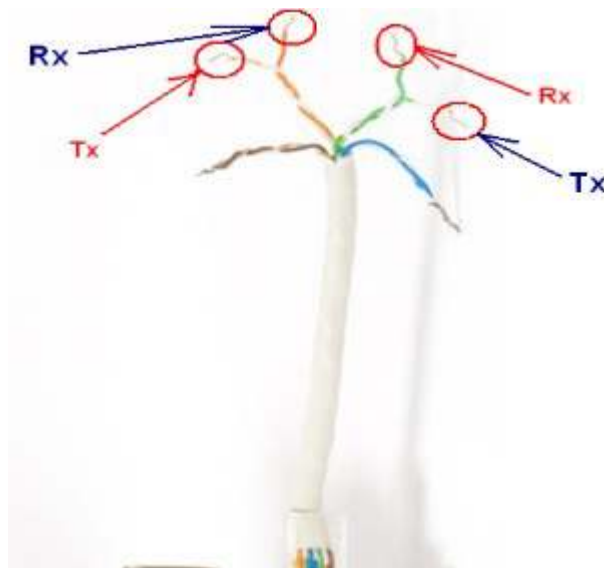

Resistance value between Rx and Tx lines must be 150 Ohm +/-4%.

If resistance value is smaller or higher then Tx/Rx line was damaged by high voltage surge.



## RB750r2 series RouterBoards

---

List of RB750r2 series:

PowerBox



**hEX lite**



**hEX PoE lite**



## Disassembling information

### PowerBox disassembling

#### 1. step

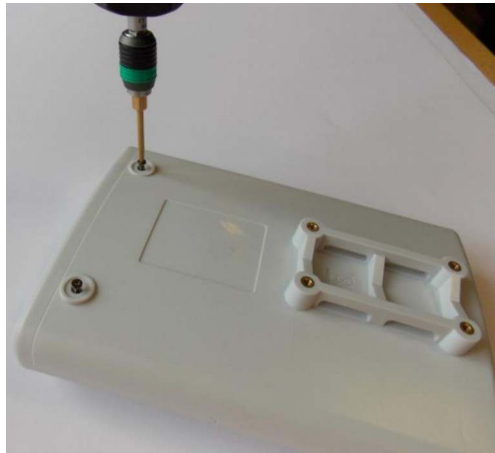

Unscrew with Torx T8

#### 2. step

Remove board from case



#### 3. Step

Incline fixed plastic clips to sever board from case.

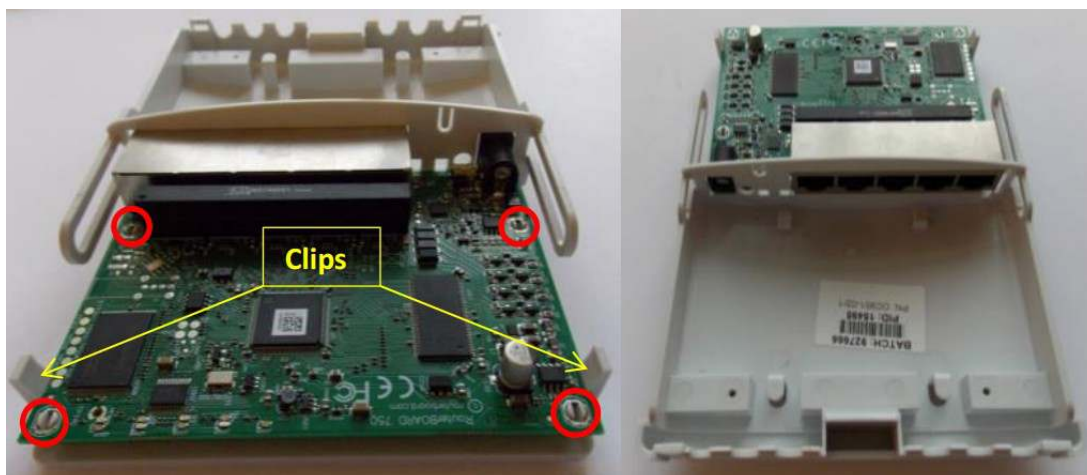

## hEX lite and hEX PoE lite disassembling

Take off the cover with a screwdriver as shown in the picture1



Picture1

Take out the board with a screwdriver as shown in the picture2

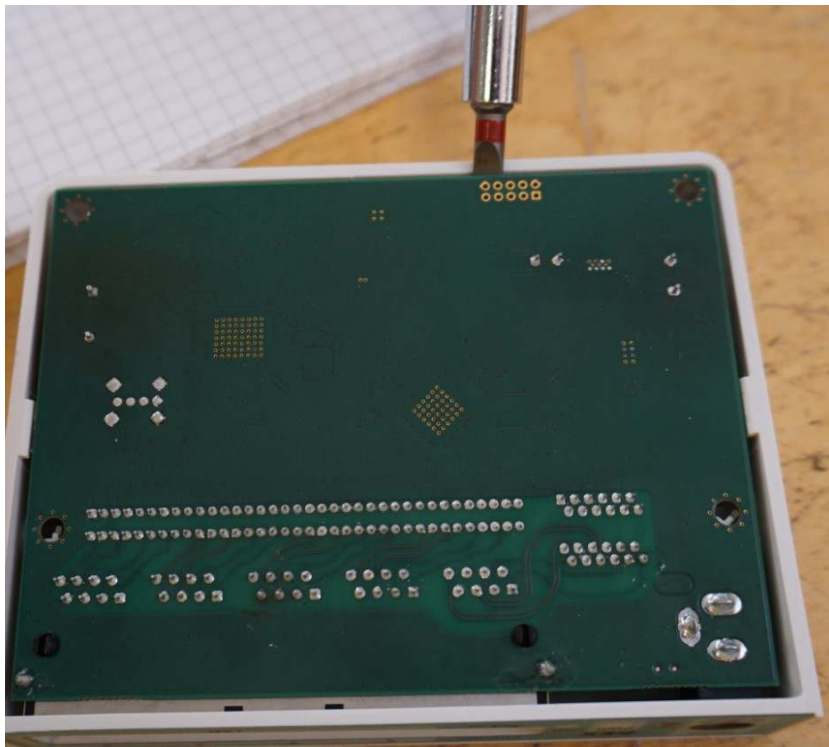

Picture1

## Schottky diode measuring with multimeter in diode mode

Schottky diode reference numbers is D7, D8, D705, D706, D707, D708; Voltage drop value should be about 0,159V for D7 and D8, and 0,215V for D705, D706, D707, D708

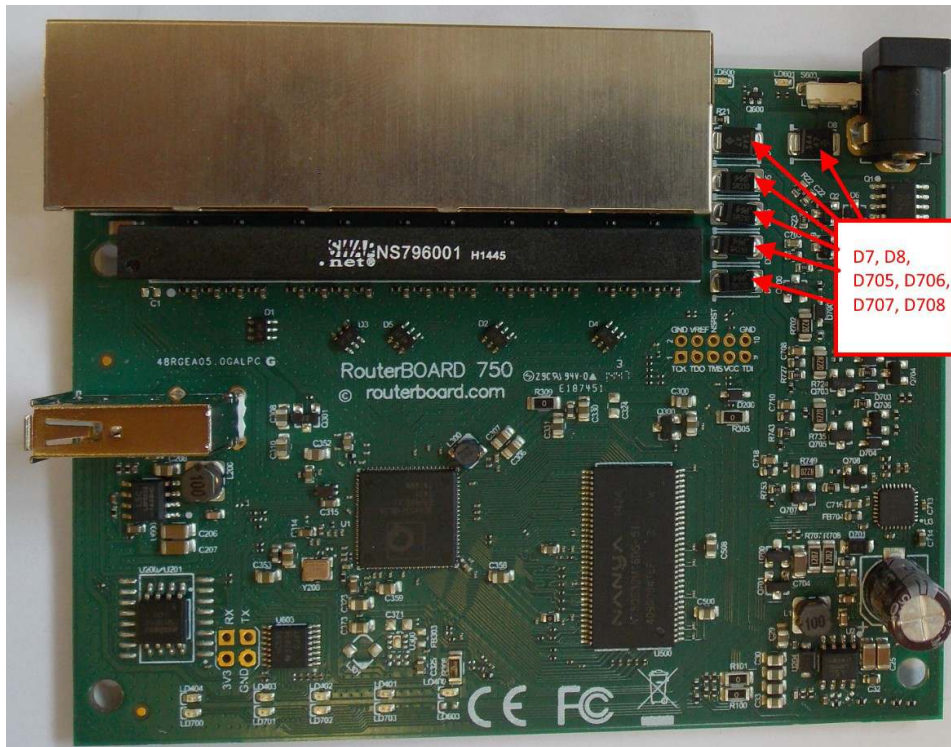

## Voltage drop between diode array pin#1 and Ground.

Check voltage drop between TR1 Ethernet Transformers on ports Ether1 – Ether5 pins and Ground. Ether Pins are circled red.

It should be in the range from 0,32V to 0,438V



## 75R termination resistors resistance

Red circled resistors resistance should be  $75\Omega \pm 1\%$

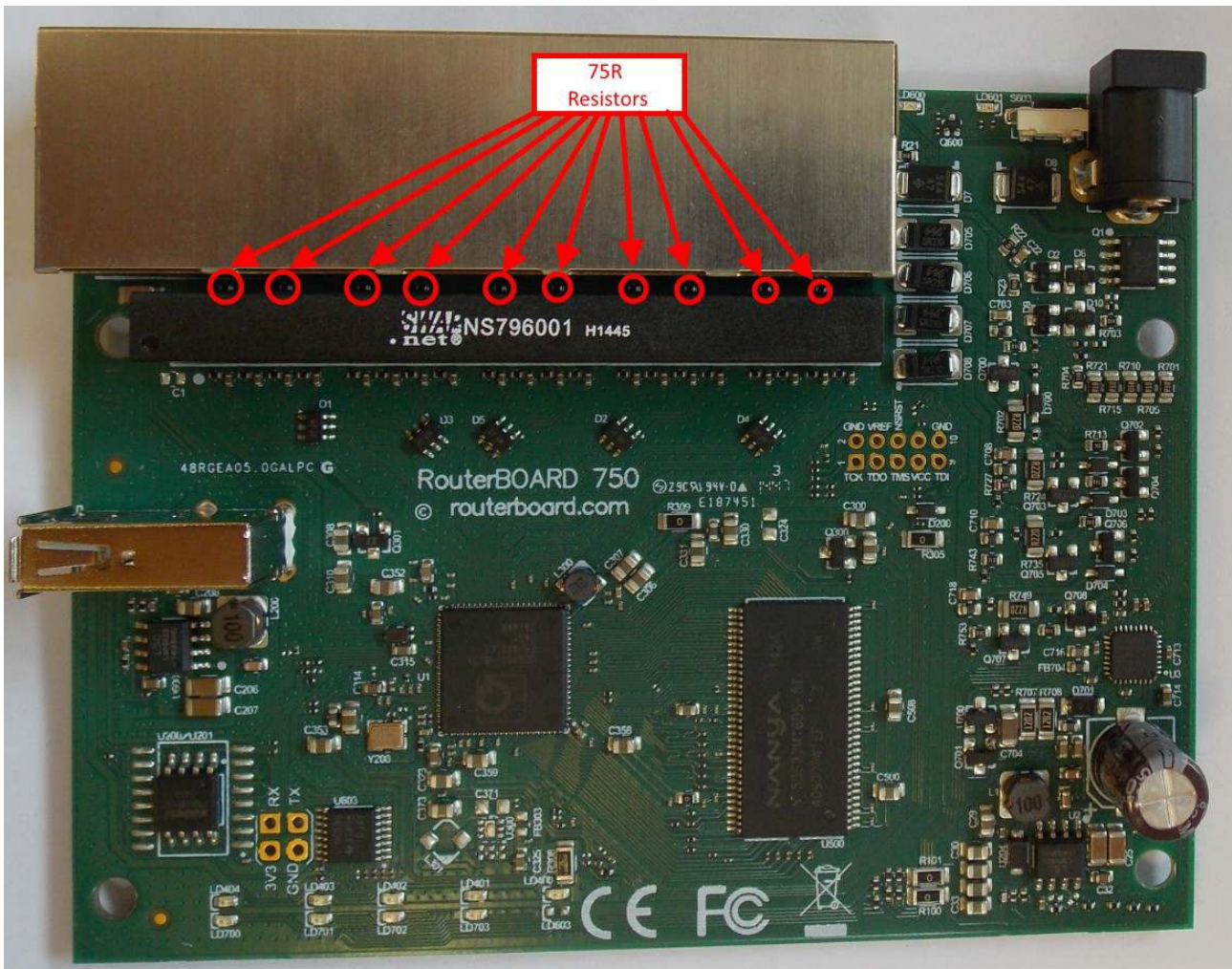

## RB922GS-5HPac series RouterBoards

---

RB922GS-5HPac series:

NetMetal 5



**QRT 5 ac**





# RB922UAGS-5HPacD

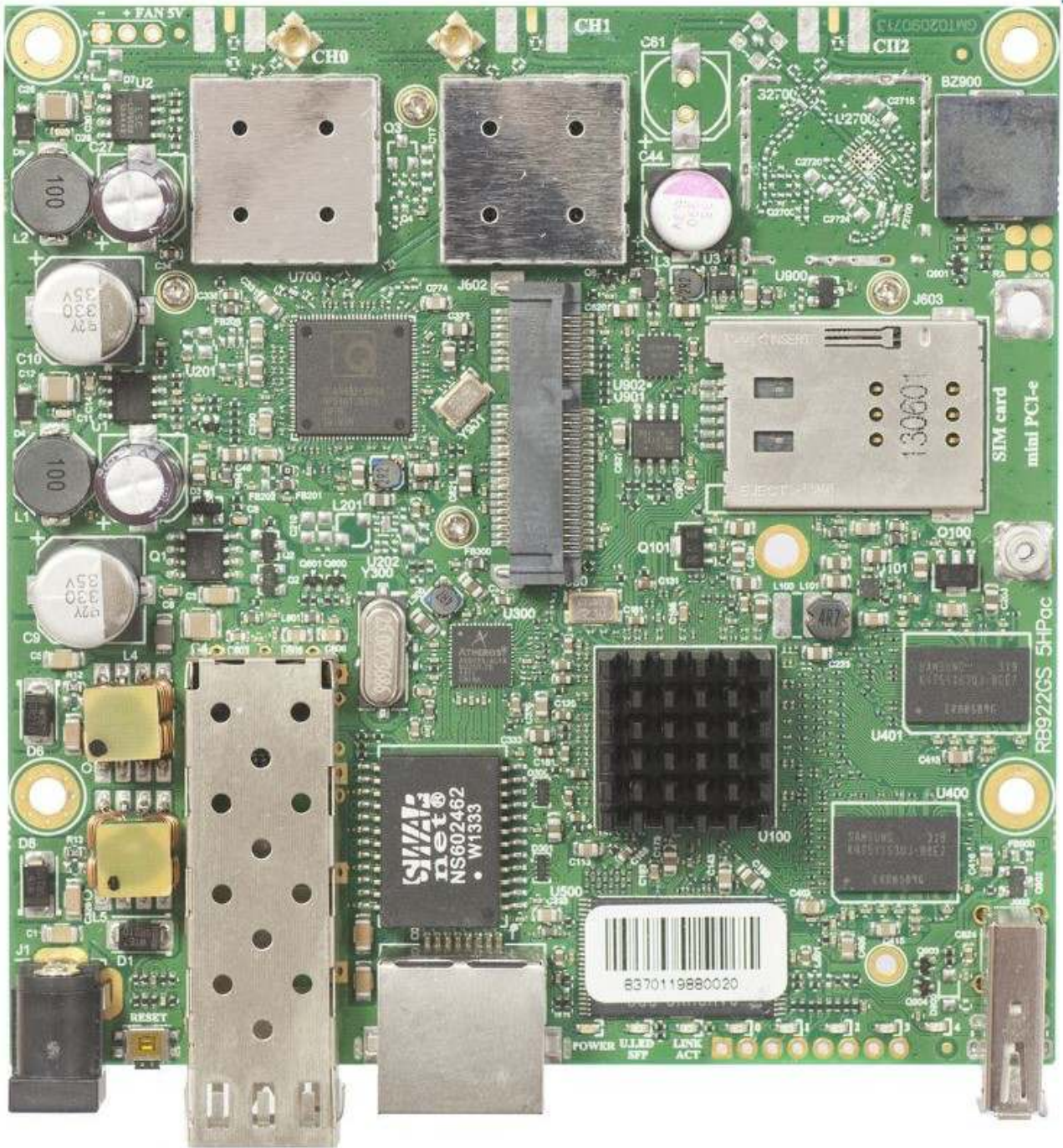

# RB911G-5HPacD

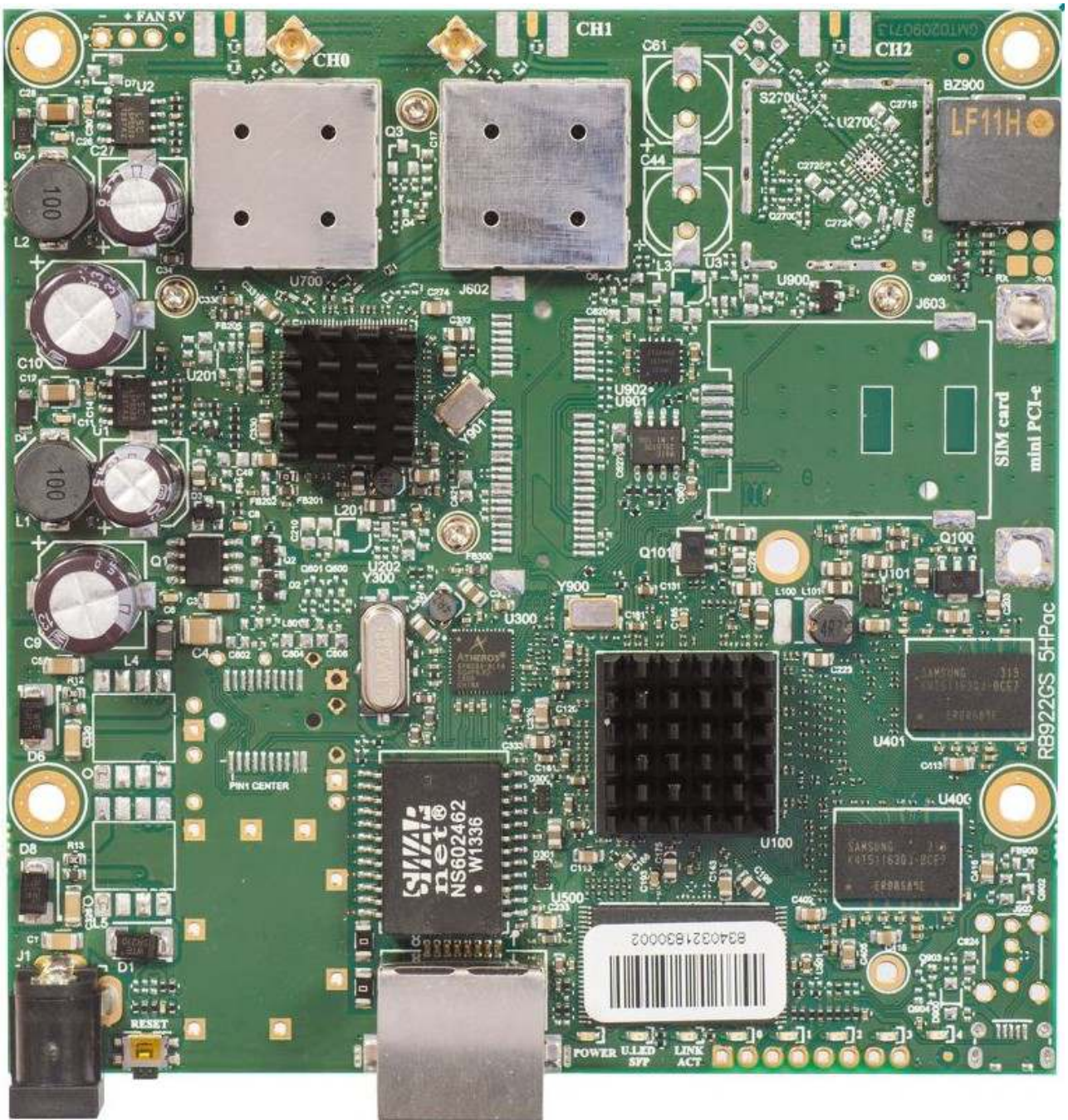

## Disassembling information

QRT 5 ac disassembling.

1. step

Remove the wing nut from Ground M4 screw

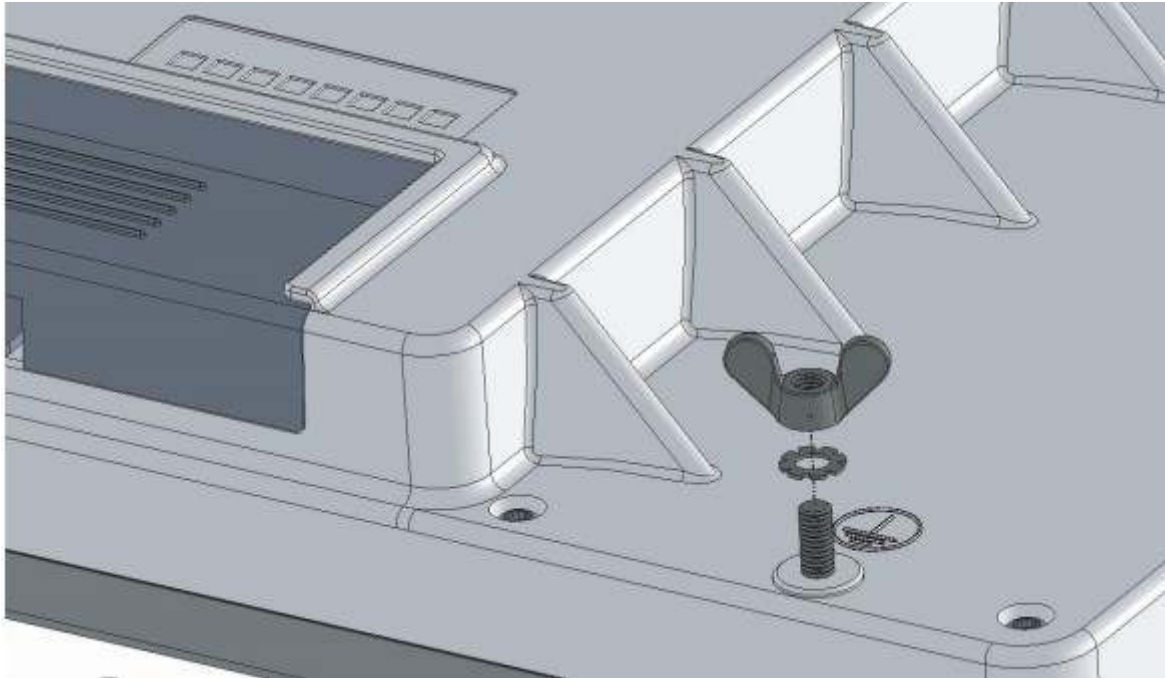

2. step

Remove the 12 pcs screws with torque screwdriver T8

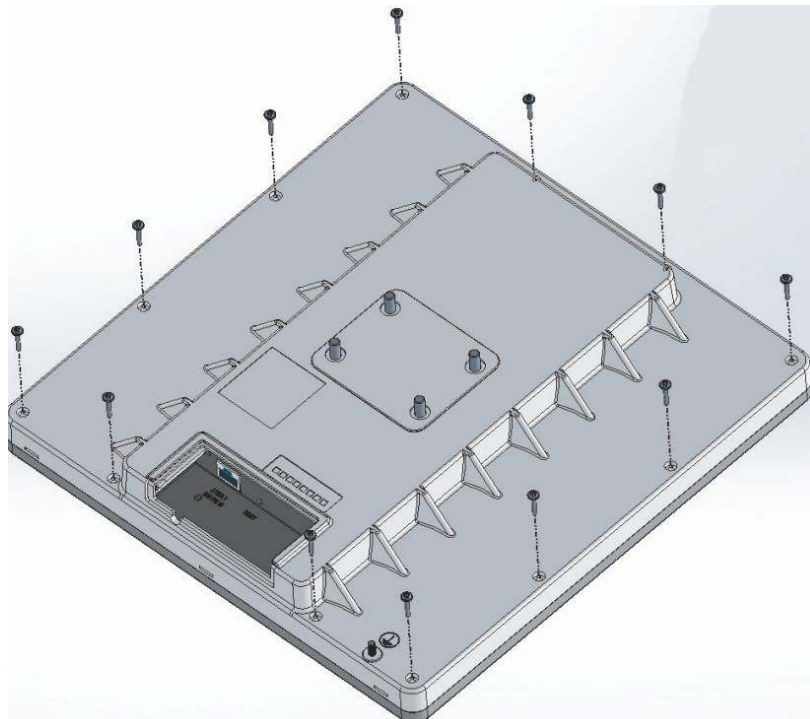

3. step

Remove the cover

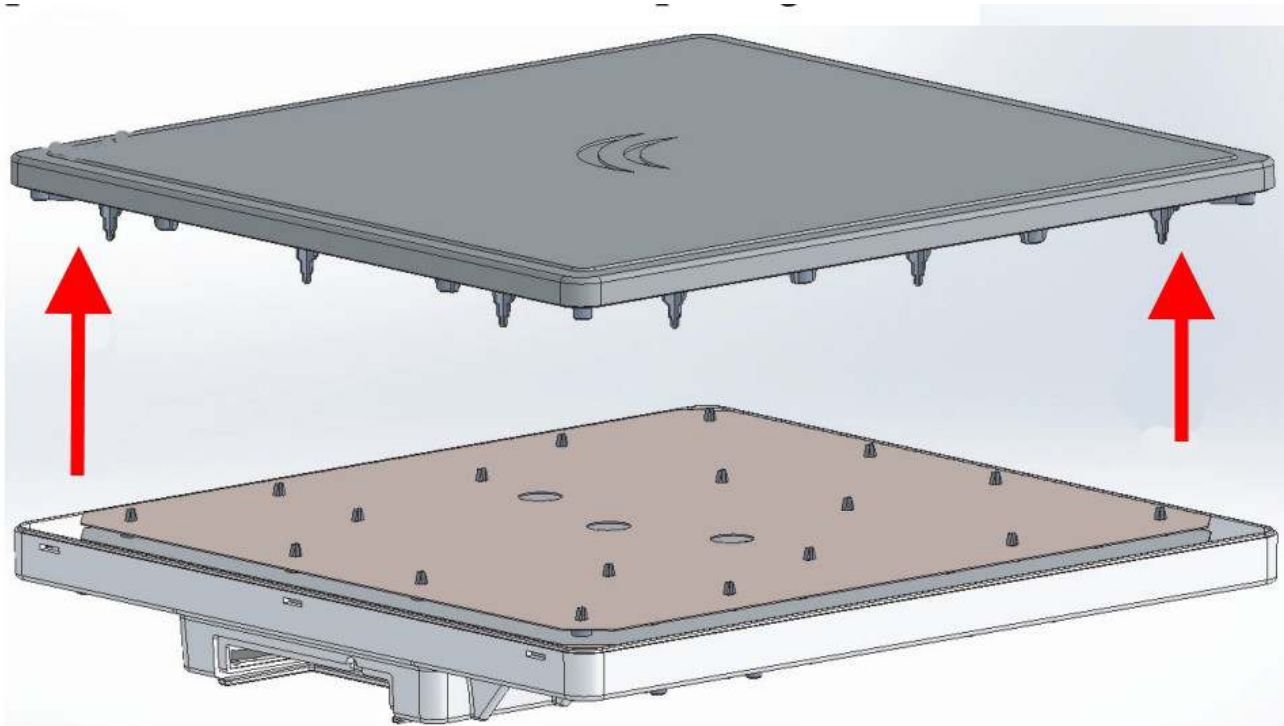

4. step

Remove the M4 screw from bottom plate and than separate bottom plate from antenna with board.

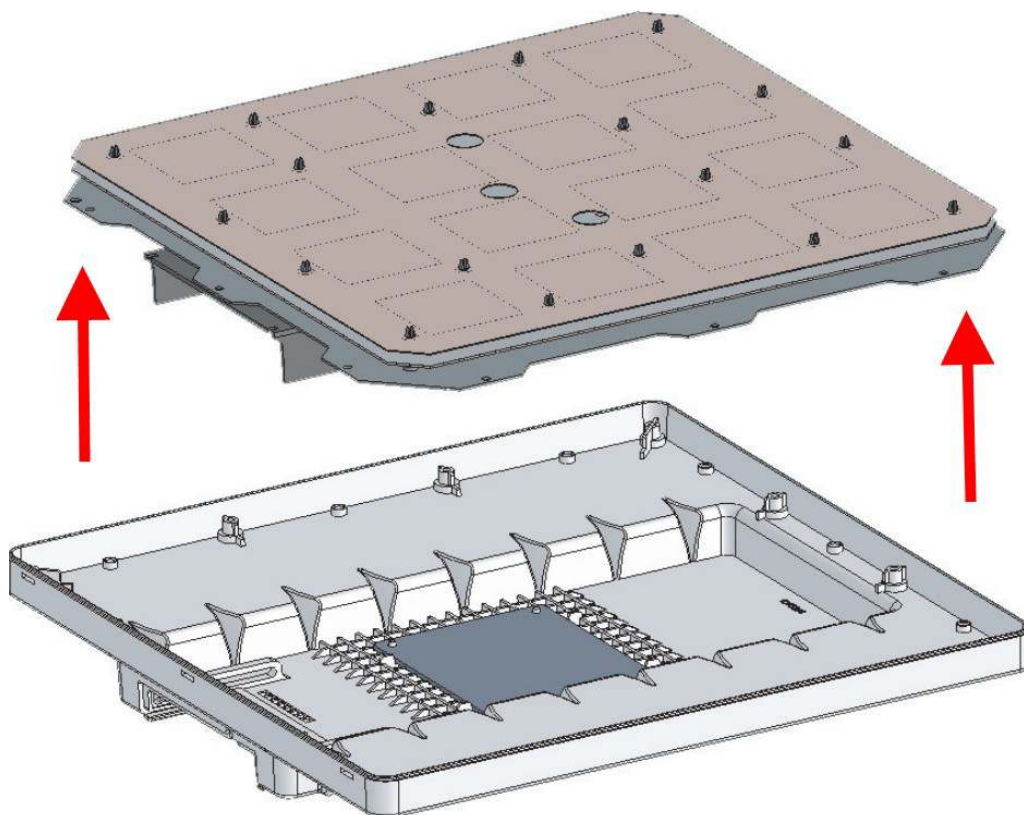

## NetMetal 5 disassembling

### 1. step

Open case and remove label from connectors

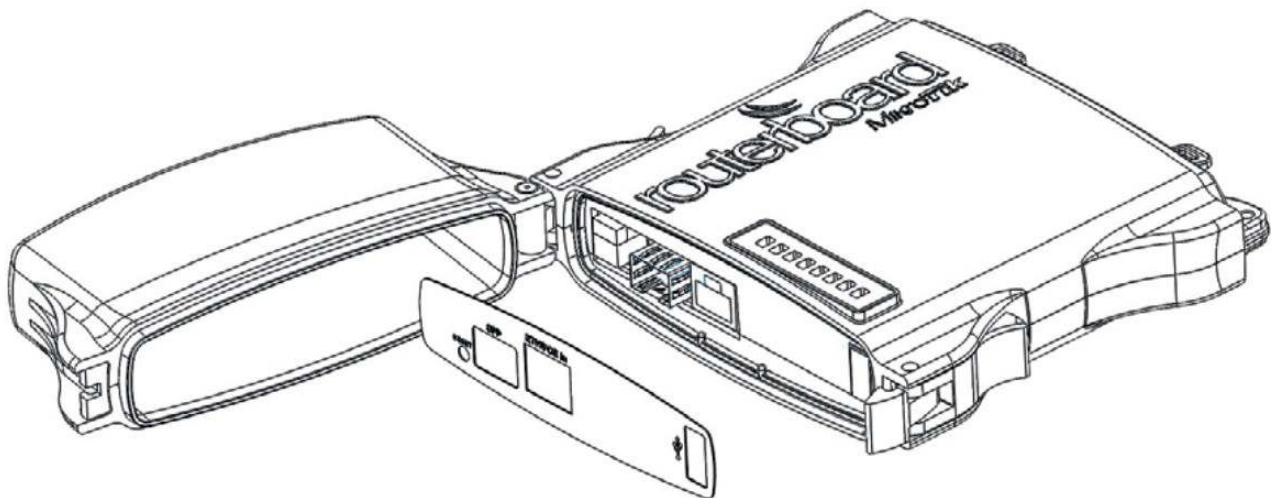

### 2. step

Remove 4 screws with hexagon key 3 mm screwdriver

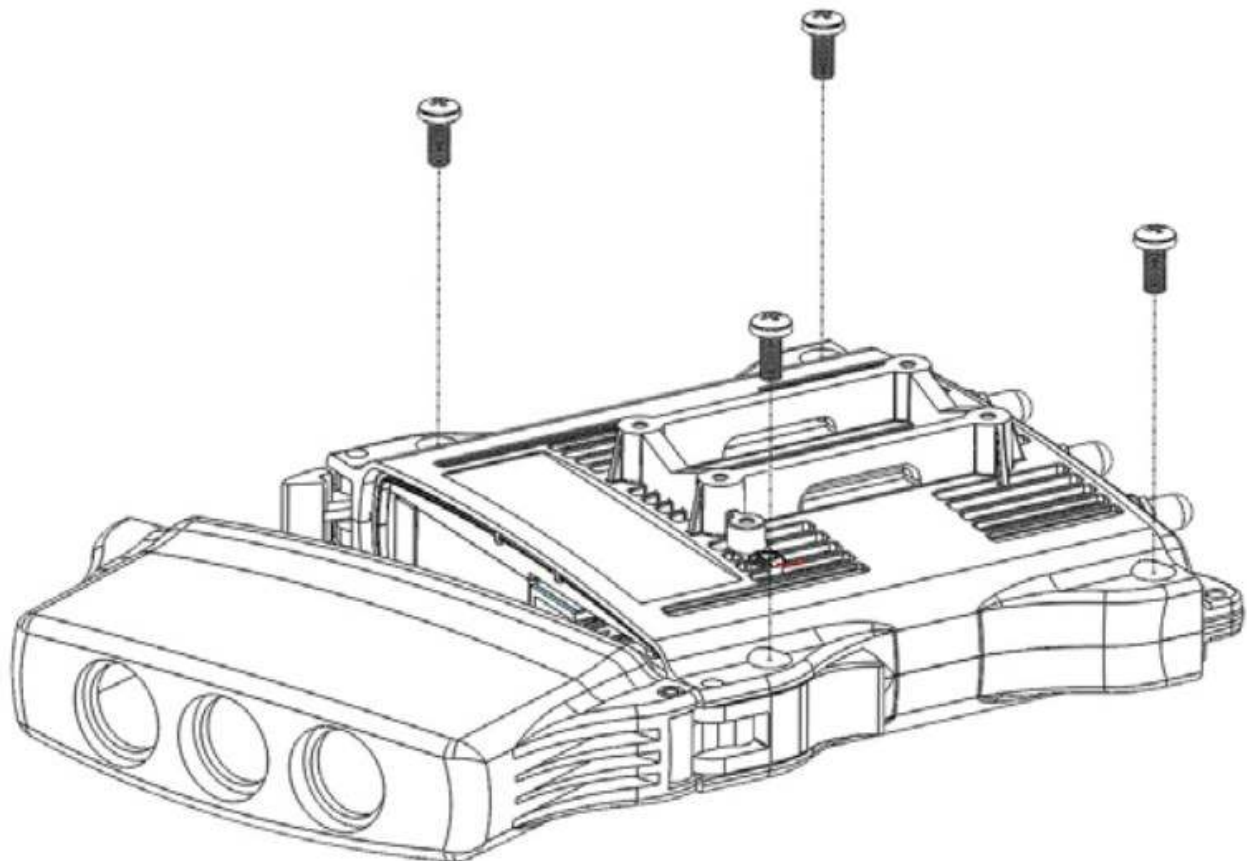

### 3. Step

Unscrew the PCB from case back with 4 pcs., M3 and 1 pcs., M2 screws

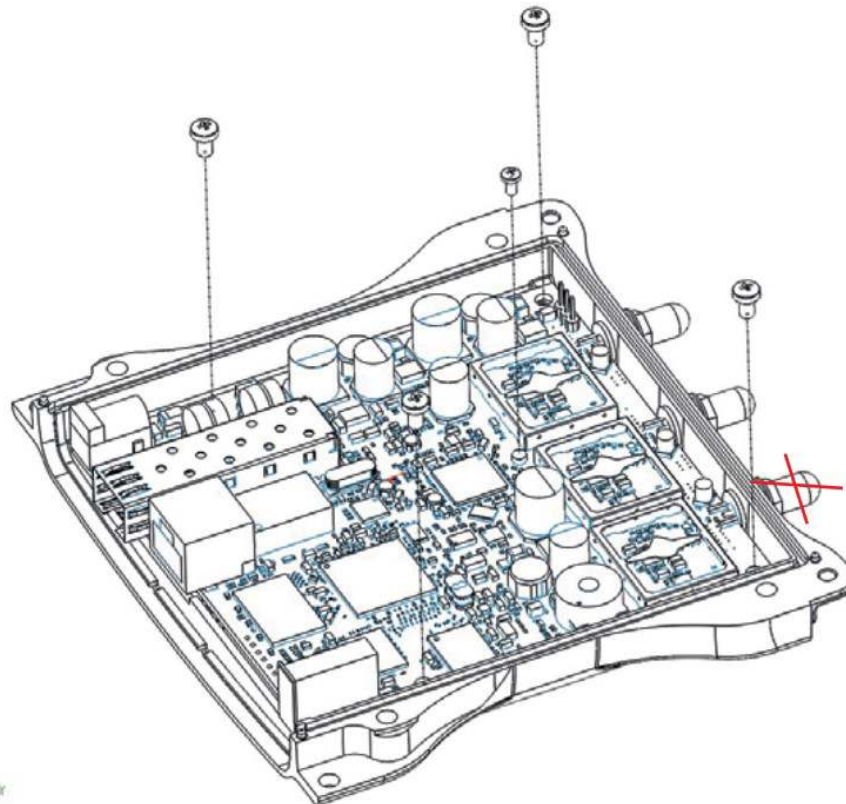

Unscrew the SMA connector nuts with 8 mm wrench.

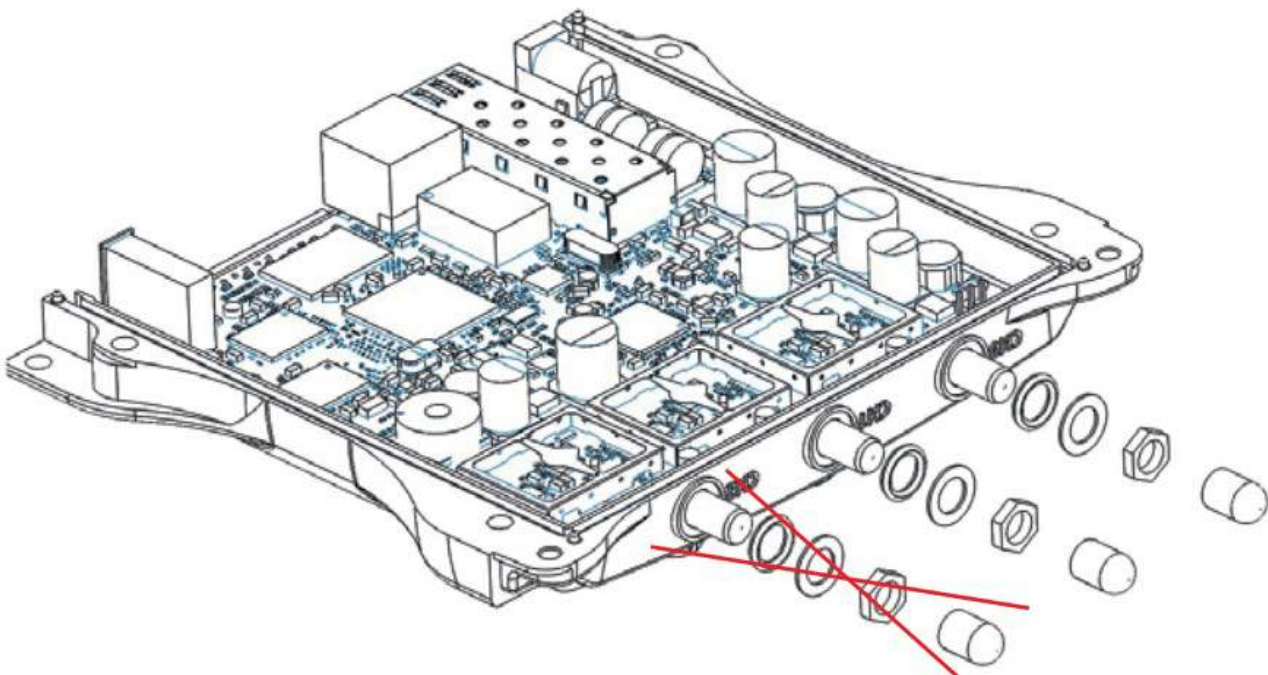

## Schottky diode measuring with multimeter in diode mode

Schottky diode reference numbers are D1, D6, D8. Voltage drop value should be about 0,18V

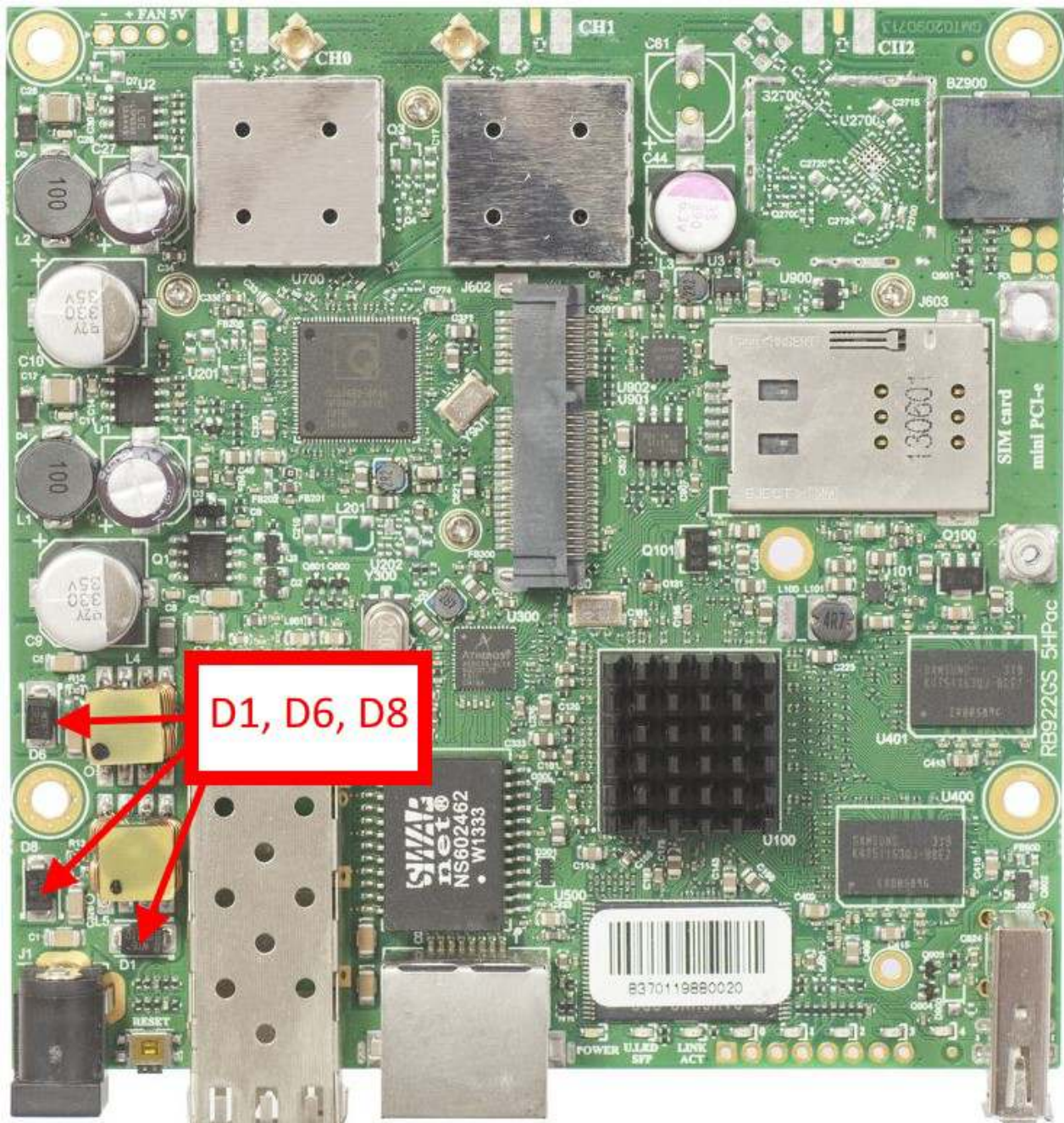

## Voltage drop between diode array pin#1 and Ground.

Check voltage drop between TR300 Ethernet Transformers on port Ether1 pins and Ground. Ether Pins are marked with red arrows.

It should be in the range from 0,32V to 0,438V

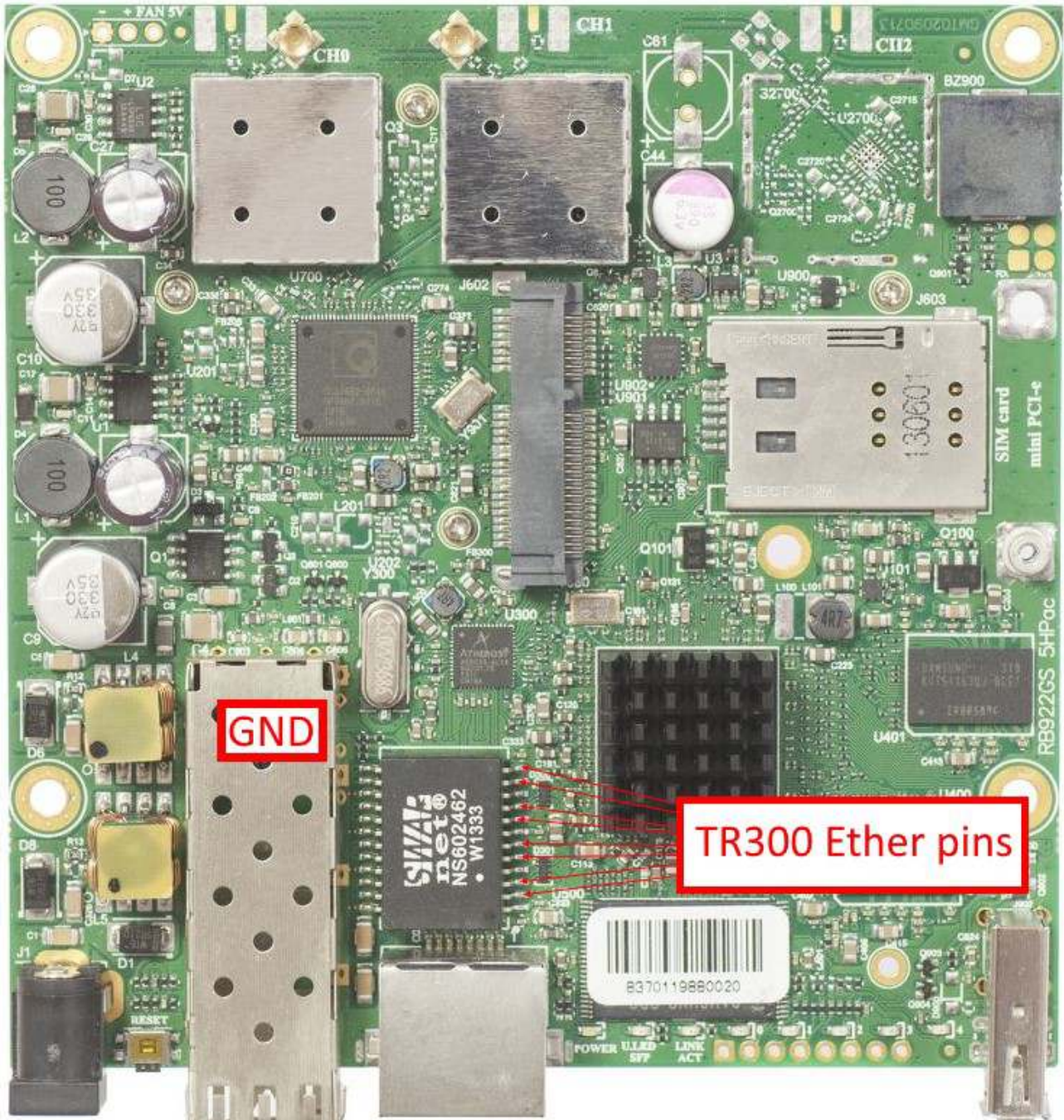



## RB921UAGS-5SHPac series RouterBoards

---

RB921GS-5HPac series:

NetMetal 5



## Disassembling information

### NetMetal 5 disassembling

#### 1. step

Open case and remove label from connectors

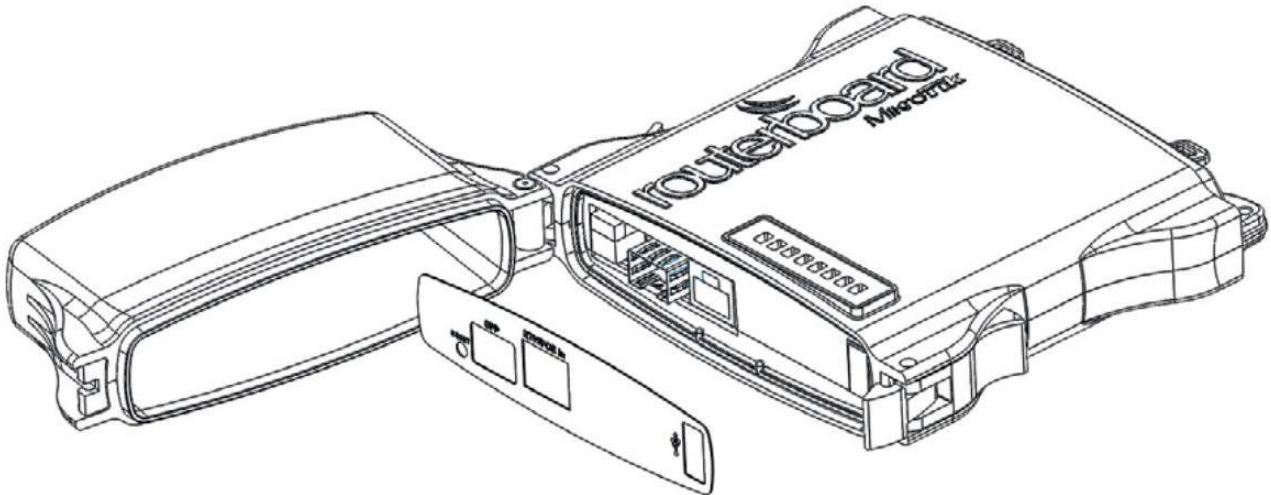

#### 2. step

Remove 4 screws with hexagon key 3 mm screwdriver

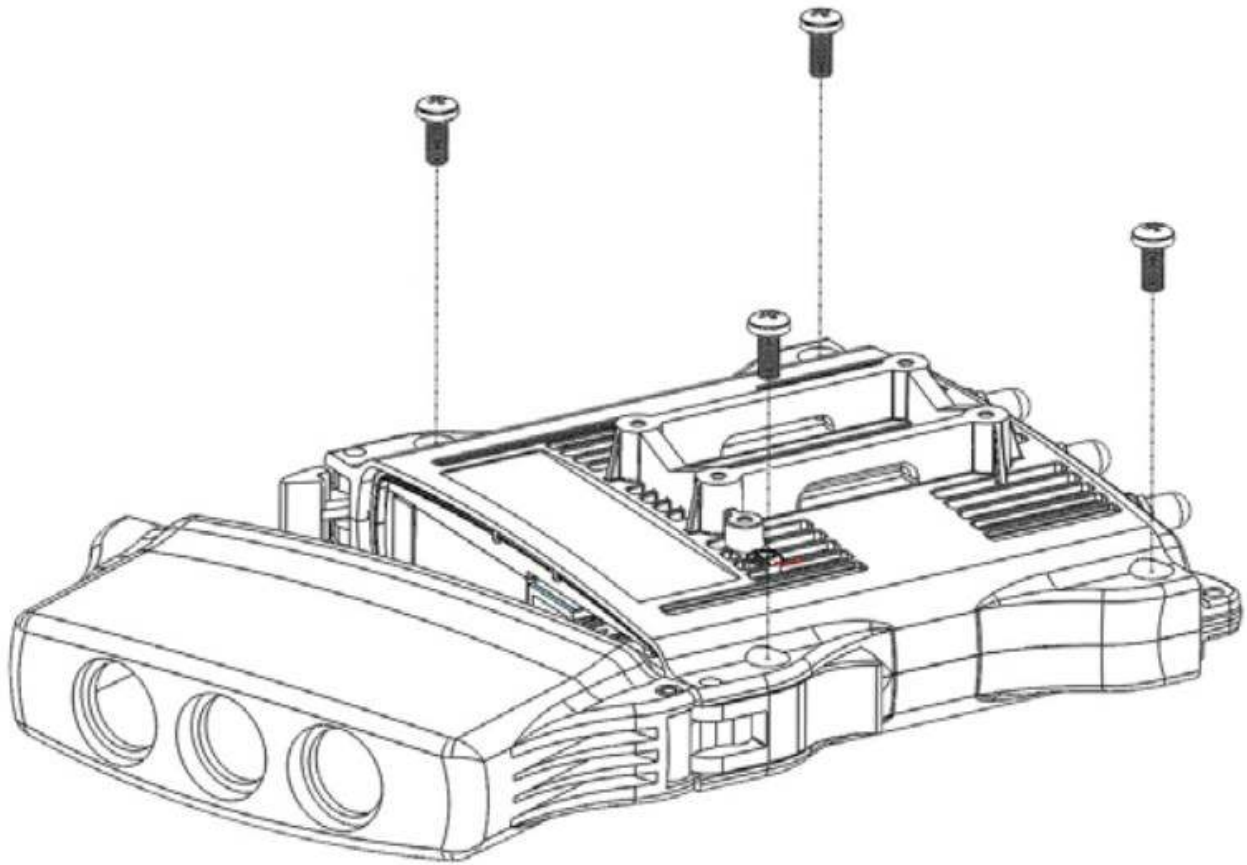

3. Step

Unscrew the PCB from case back with 4 pcs., M3 and 1 pcs., M2 screws

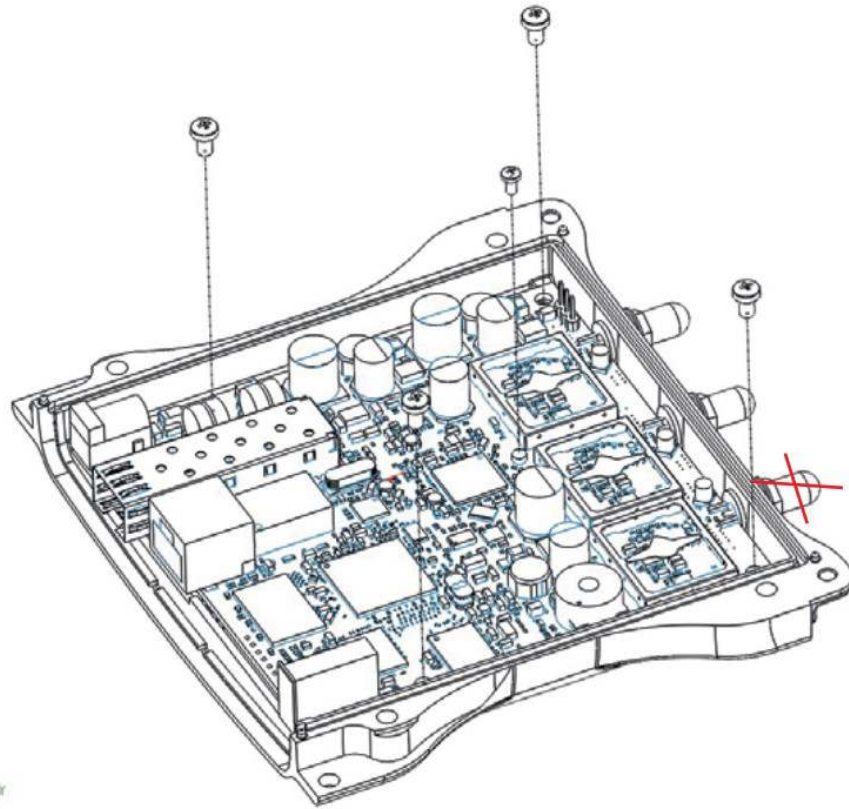

Unscrew the SMA connector nuts with 8 mm wrench.

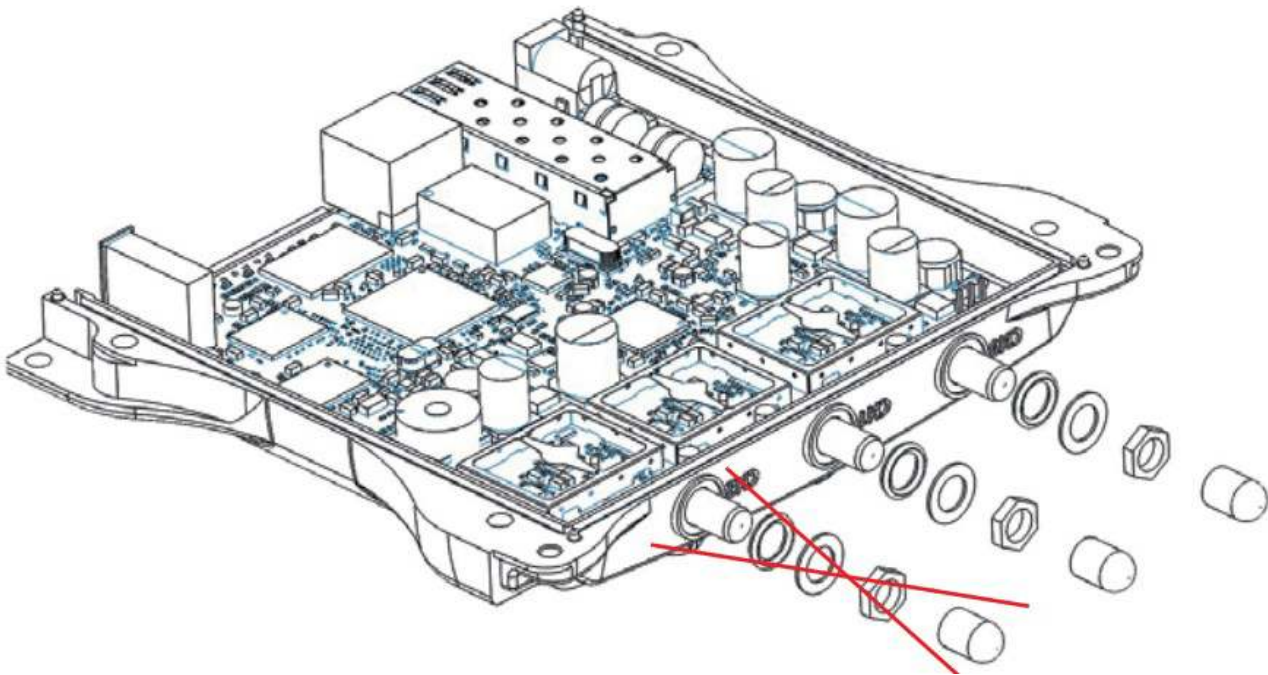

## Schottky diode measuring with multimeter in diode mode

Schottky diode reference numbers are D8. Voltage drop value should be about 0,18V

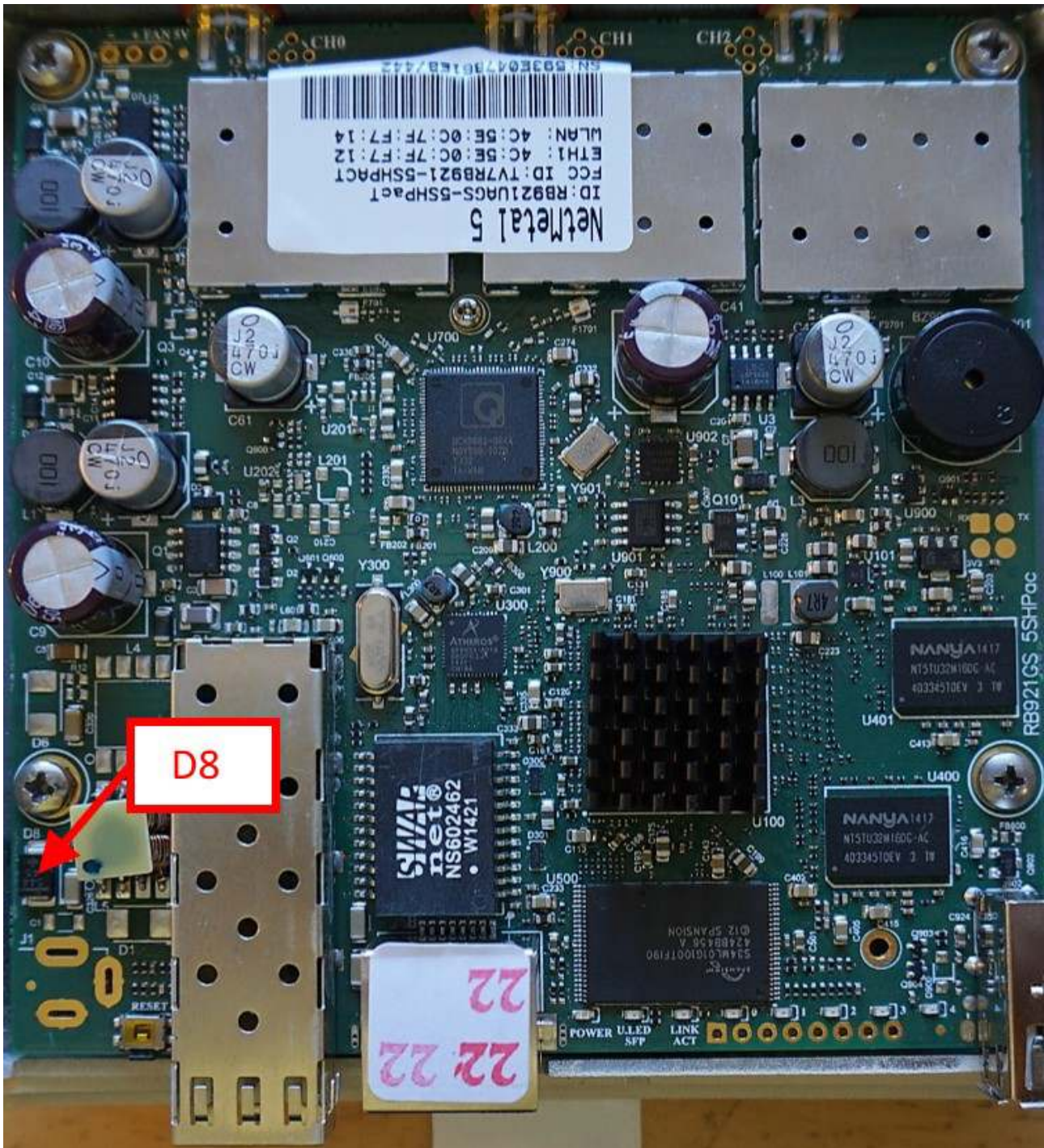

## Voltage drop between diode array pin#1 and Ground.

Check voltage drop between TRF300 Ethernet Transformers on port Ether1 pins and Ground. Ether Pins are marked with red arrows.

It should be in the range from 0,32V to 0,438V

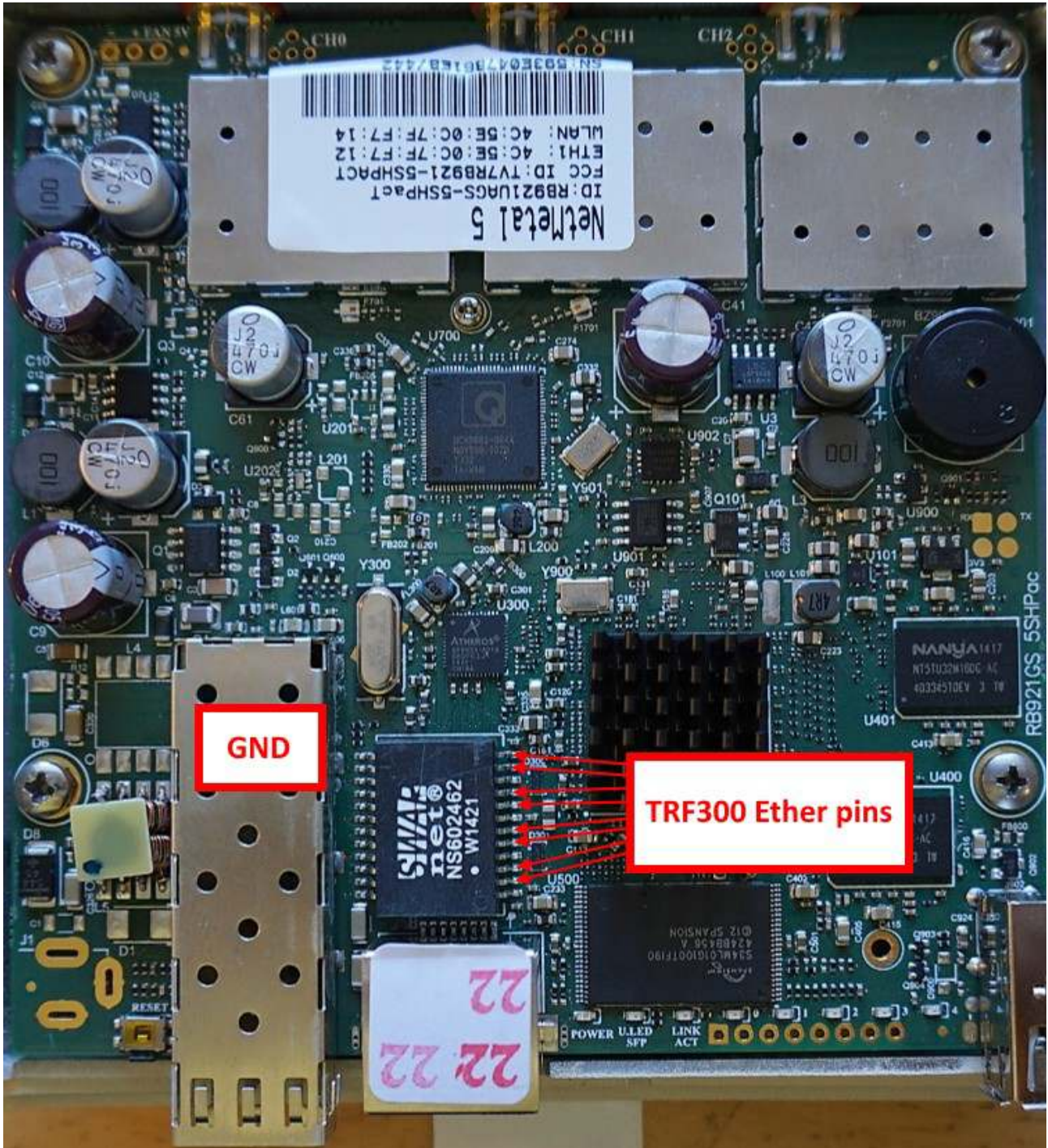

## RBmAP series RouterBoards

---

RBmAP series:

mAP 2n



## Disassembling information

### mAP 2n disassembling

#### 1. step

Push the white clip to open the case



#### 2. step

Remove front case

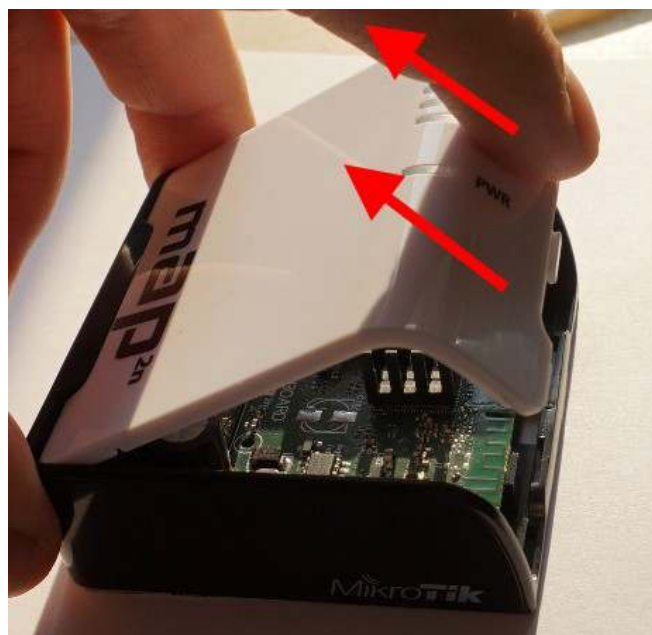



3. Step

Remove board from case



## Schottky diode measuring with multimeter in diode mode

Schottky diode reference numbers are D1, D7, D9, D11 on top layer. Voltage drop value should be about 0,35V

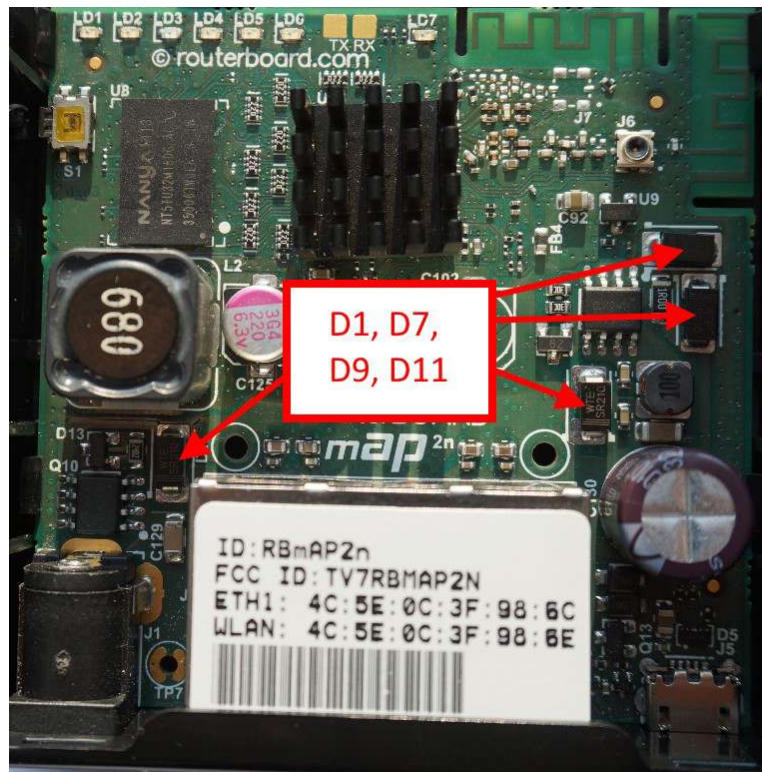

Schottky diode reference numbers are D2, D12 on bottom layer. Voltage drop value should be about 0,35V

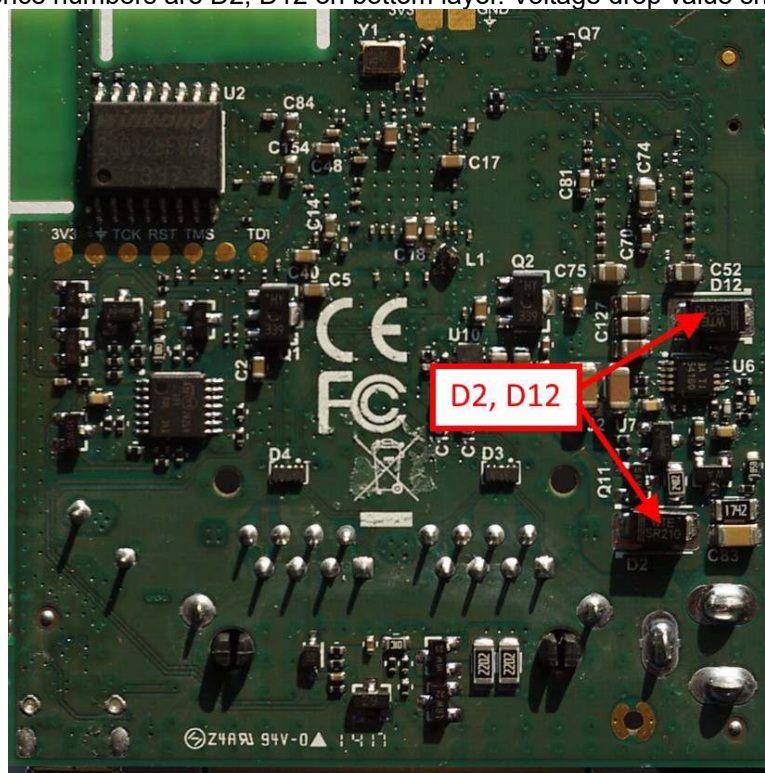



## RBcAP series RouterBoards

---

RBcAP series:

cAP 2n

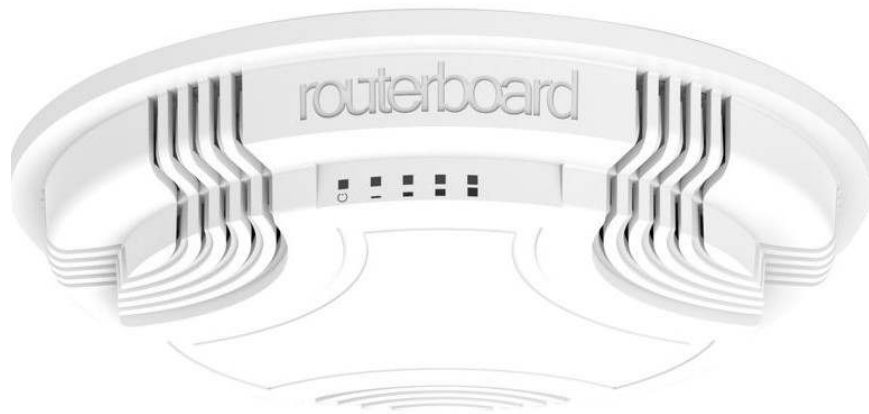

## Disassembling information

### cAP 2n disassembling

#### 1. step

Push the outer edge around clips to open the case

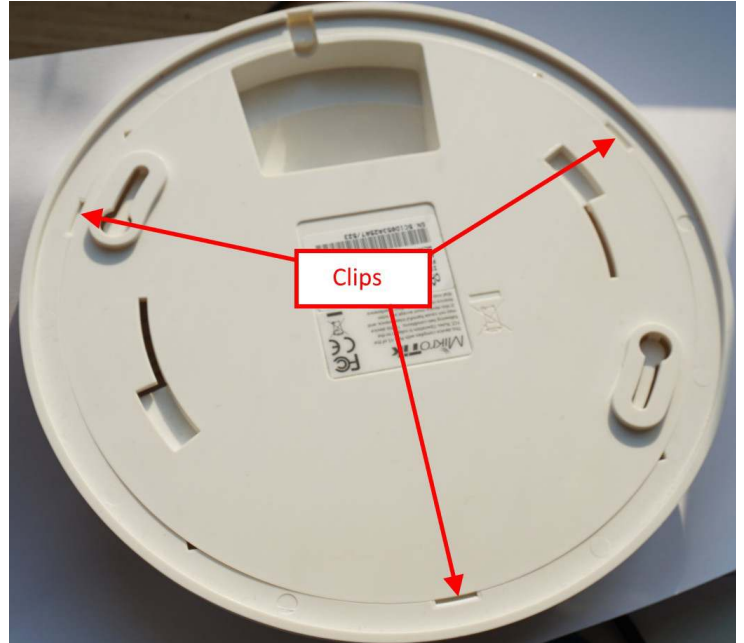

#### 2. step

Remove cover and take out the board from case

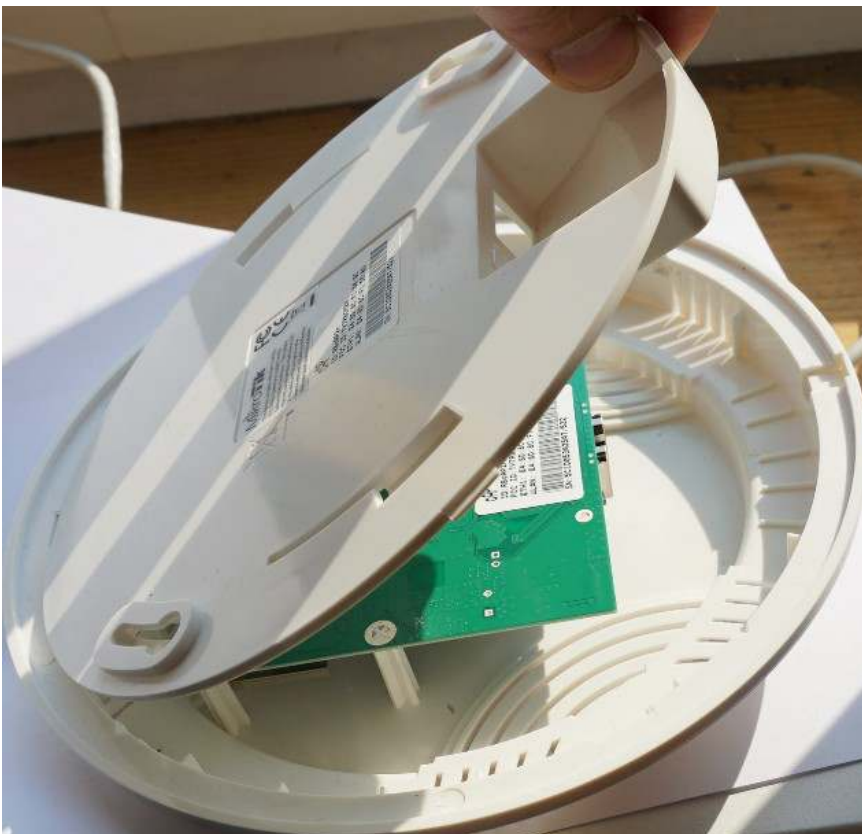

## Schottky diode measuring with multimeter in diode mode

Schottky diode reference numbers are D1, D3 . Voltage drop value should be about 0,35V

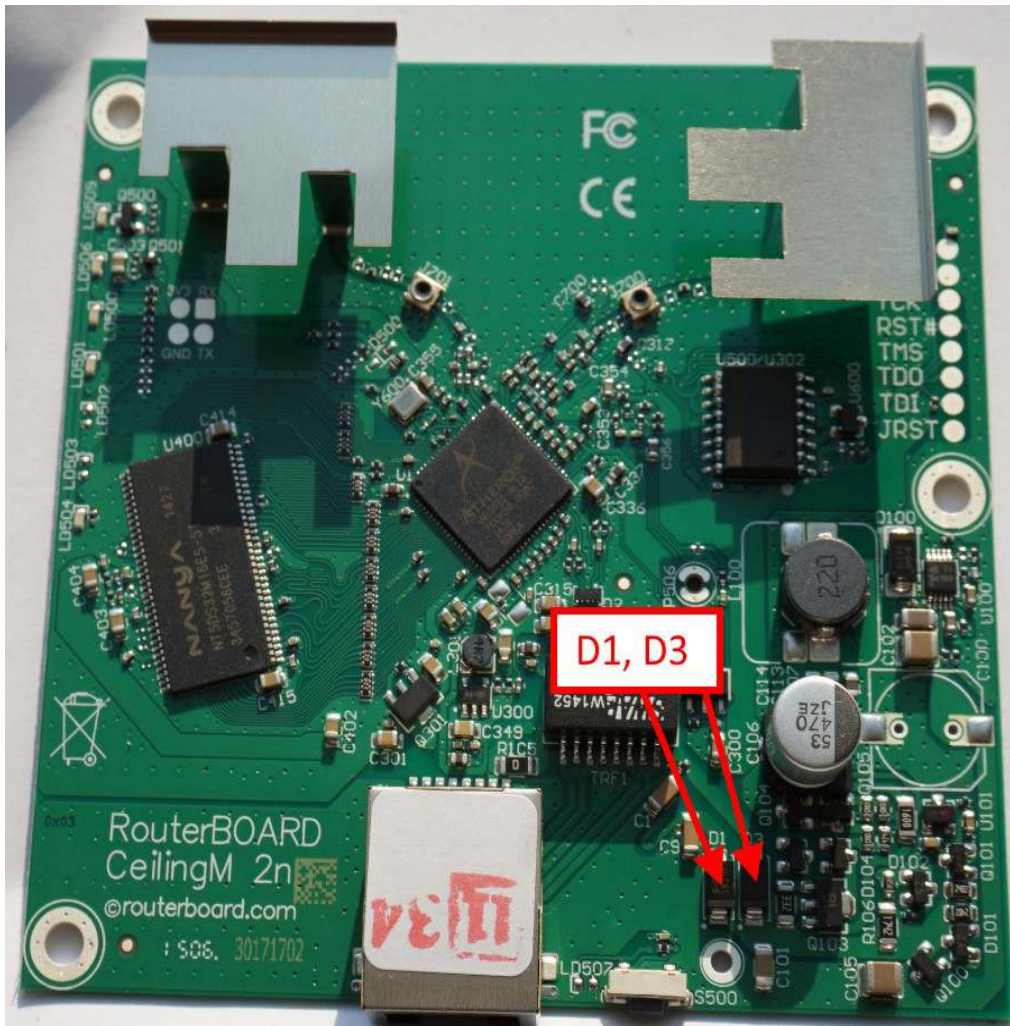

## Voltage drop between diode array pin#1 and Ground.

Check voltage drop between TRF1 Ethernet Transformers pins and Ground. Ether Pins are marked with red arrows.

It should be in the range from 0,32V to 0,478V

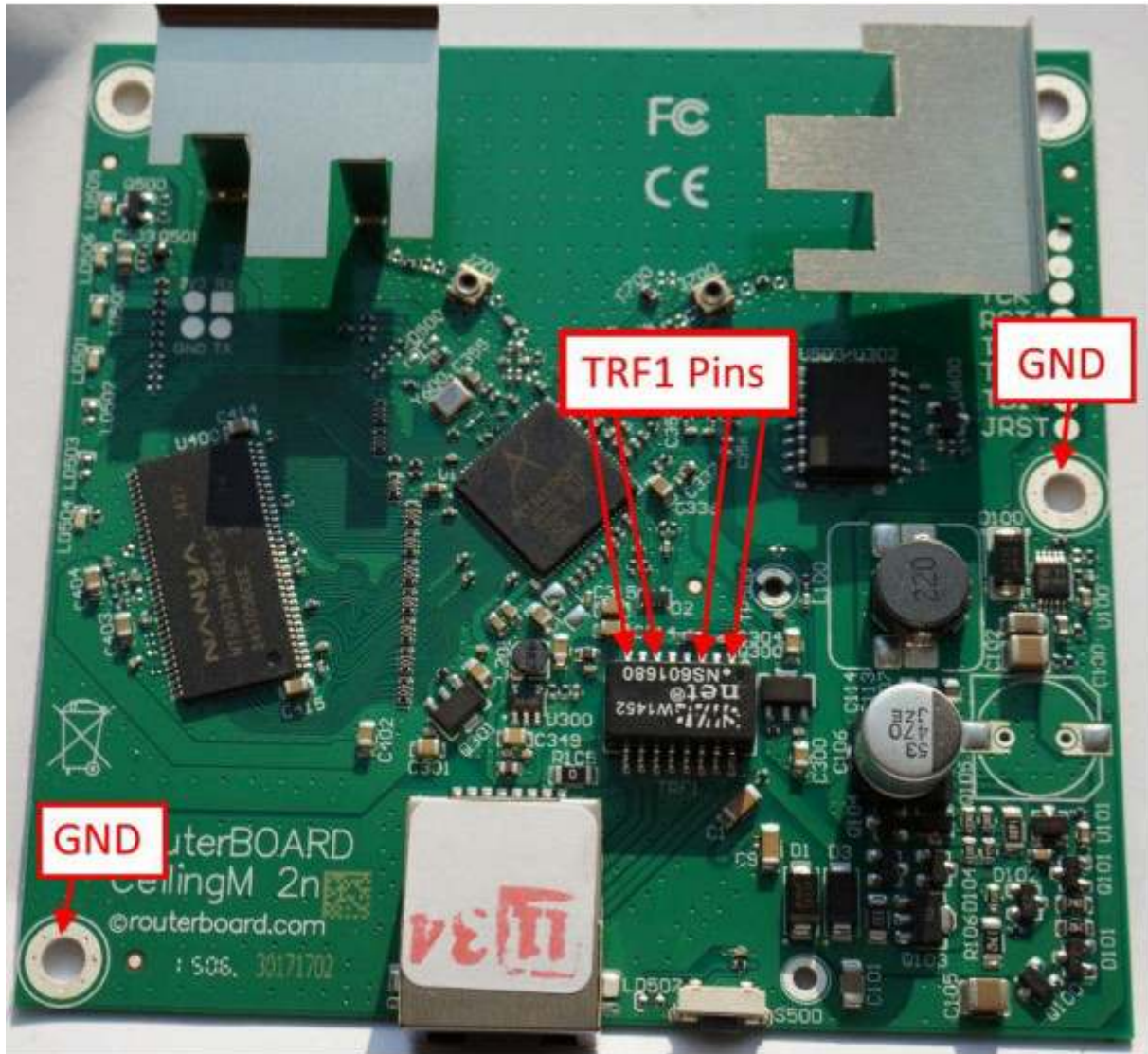

## 75R Termination resistors resistance.

Resistor resistance, marked with red arrow, should be 75 Ohm +/- 1%

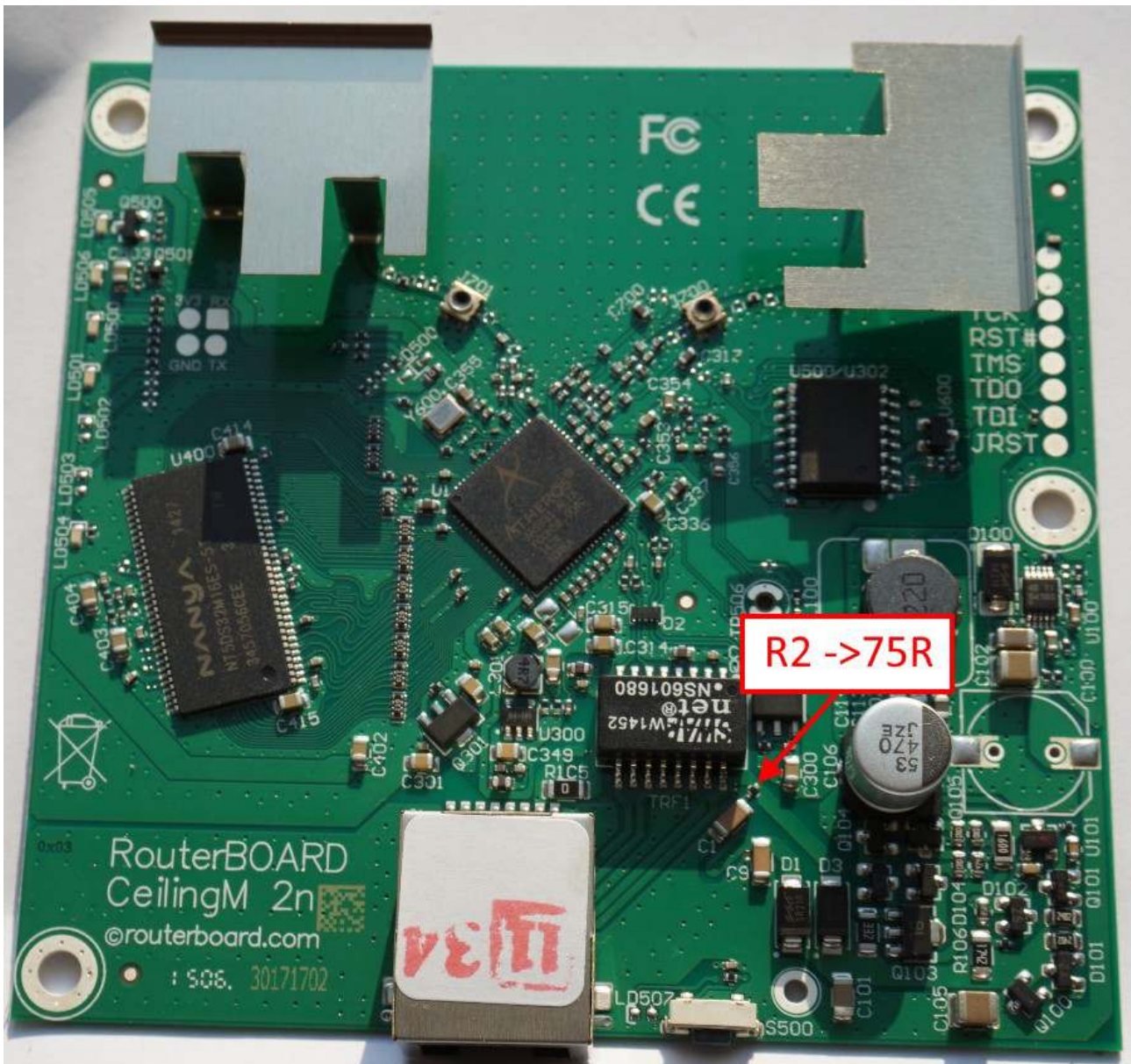



## RBDynaDish series RouterBoards

---

RBDynaDish series:

DynaDish 5



## Disassembling information

### DynaDish 5 disassembling

#### 1. step

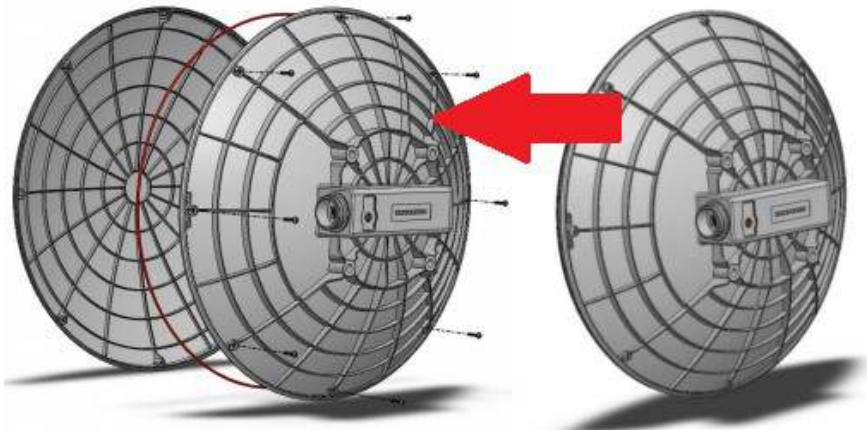

Unscrew 8 pcs screws with TX10 screwdriver and remove the antenna cover as shown in picture

#### 2. step

Unscrew 4 pcs screws with TX10 screwdriver and remove the board from the antenna construction as shown in picture.

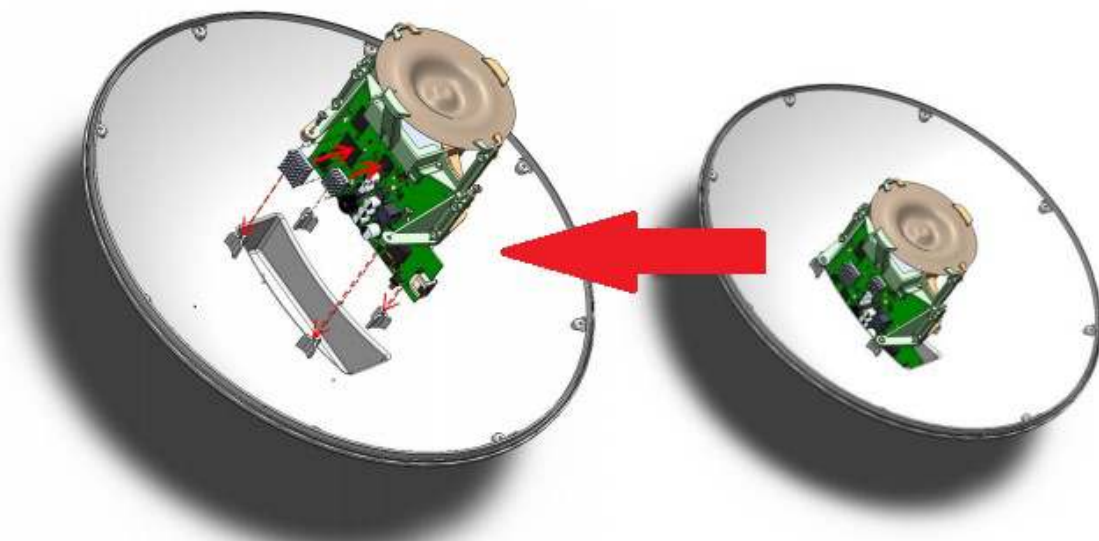

## Schottky diode measuring with multimeter in diode mode

Schottky diode reference number is D109; Voltage drop value should be about 0,197V  
Diode bridge reference number is D111. Voltage drop value should be about 0,675V

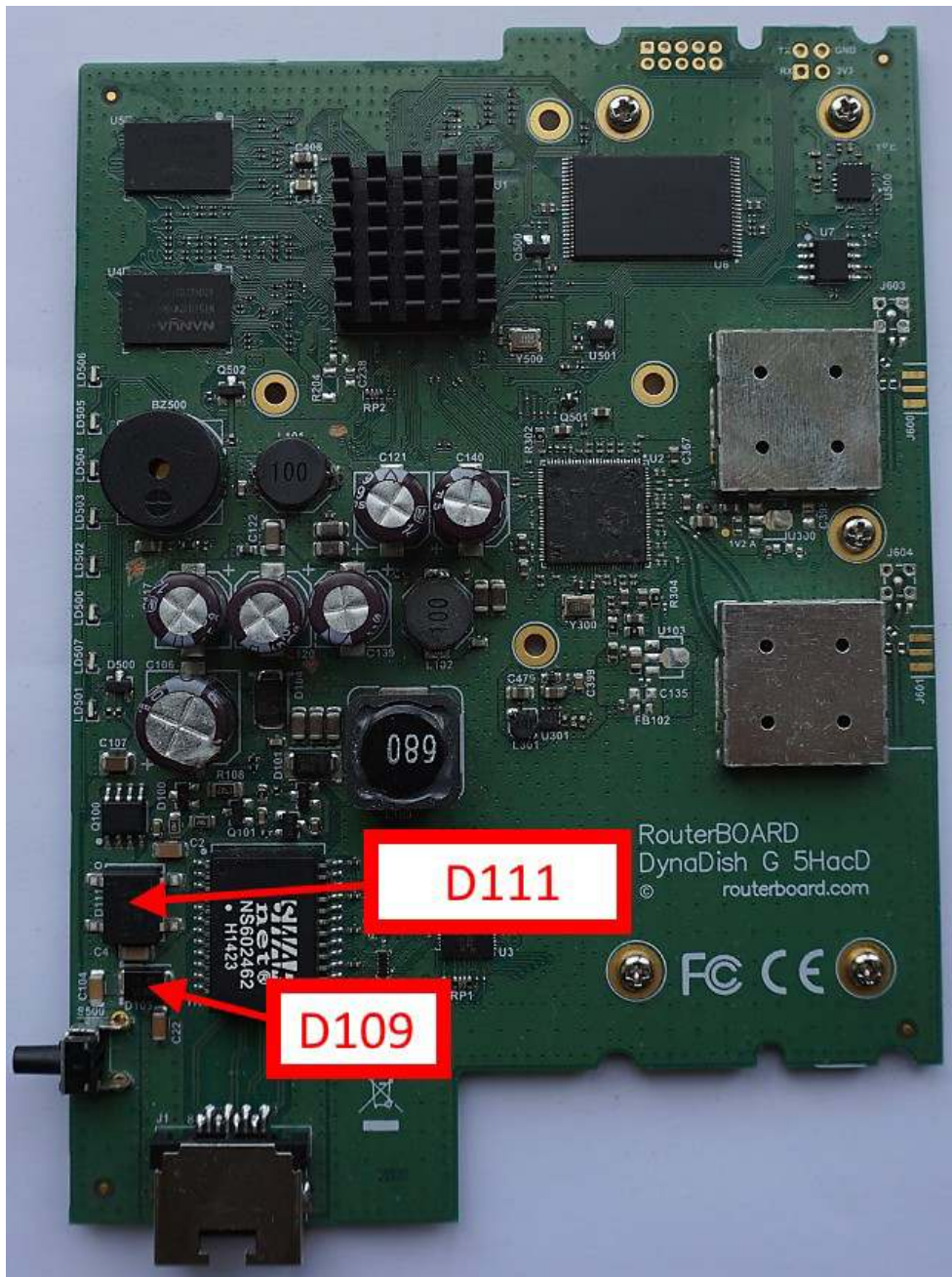

## Voltage drop between diode array pin#1 and Ground.

Check voltage drop between TR1 Ethernet Transformers pins and Ground. Ether Pins are marked with red arrows.

It should be in the range from 0,32V to 0,487V

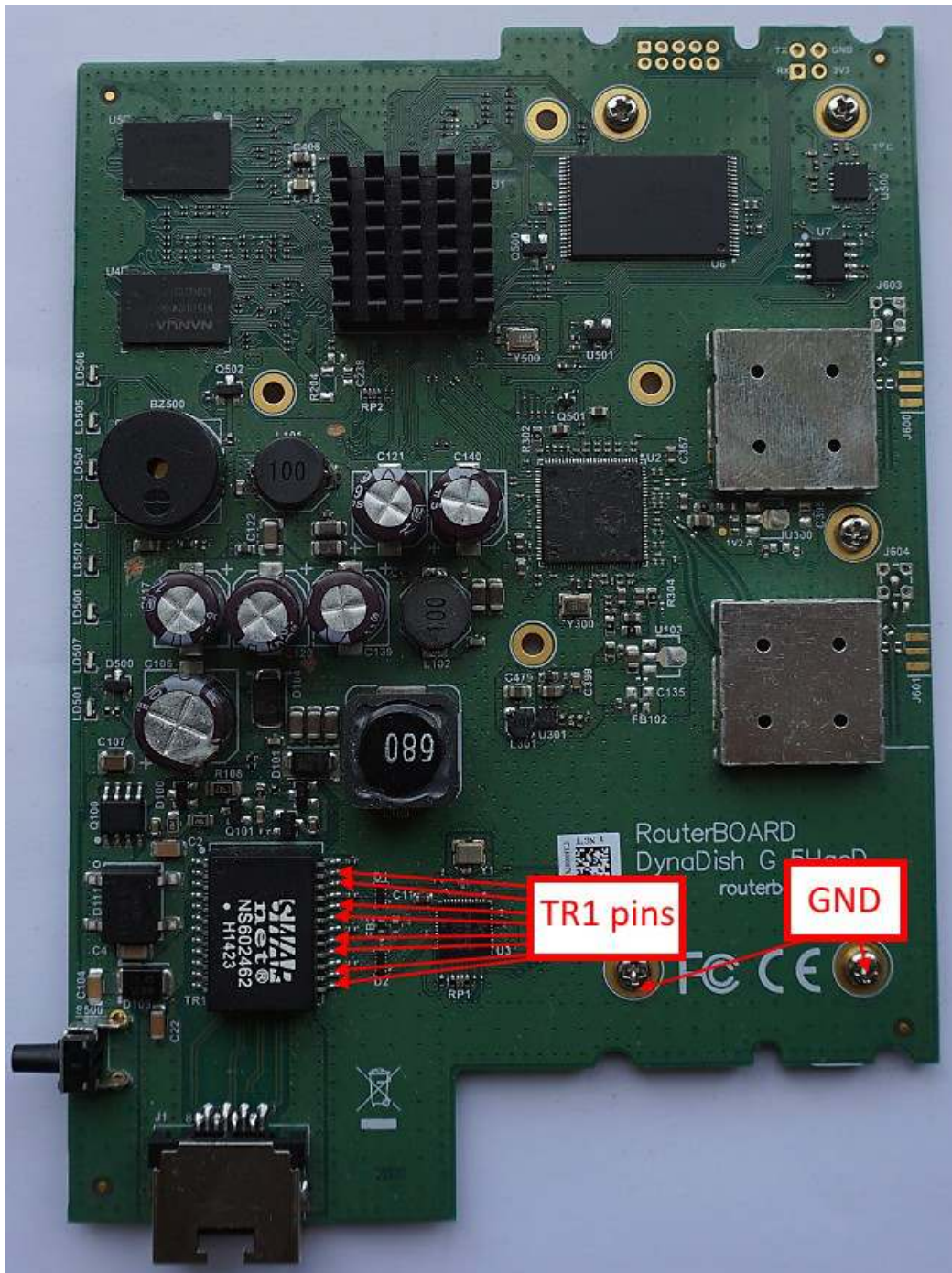

# RB953GS-5HnT series RouterBoards

## RB953GS-5HnT-RP

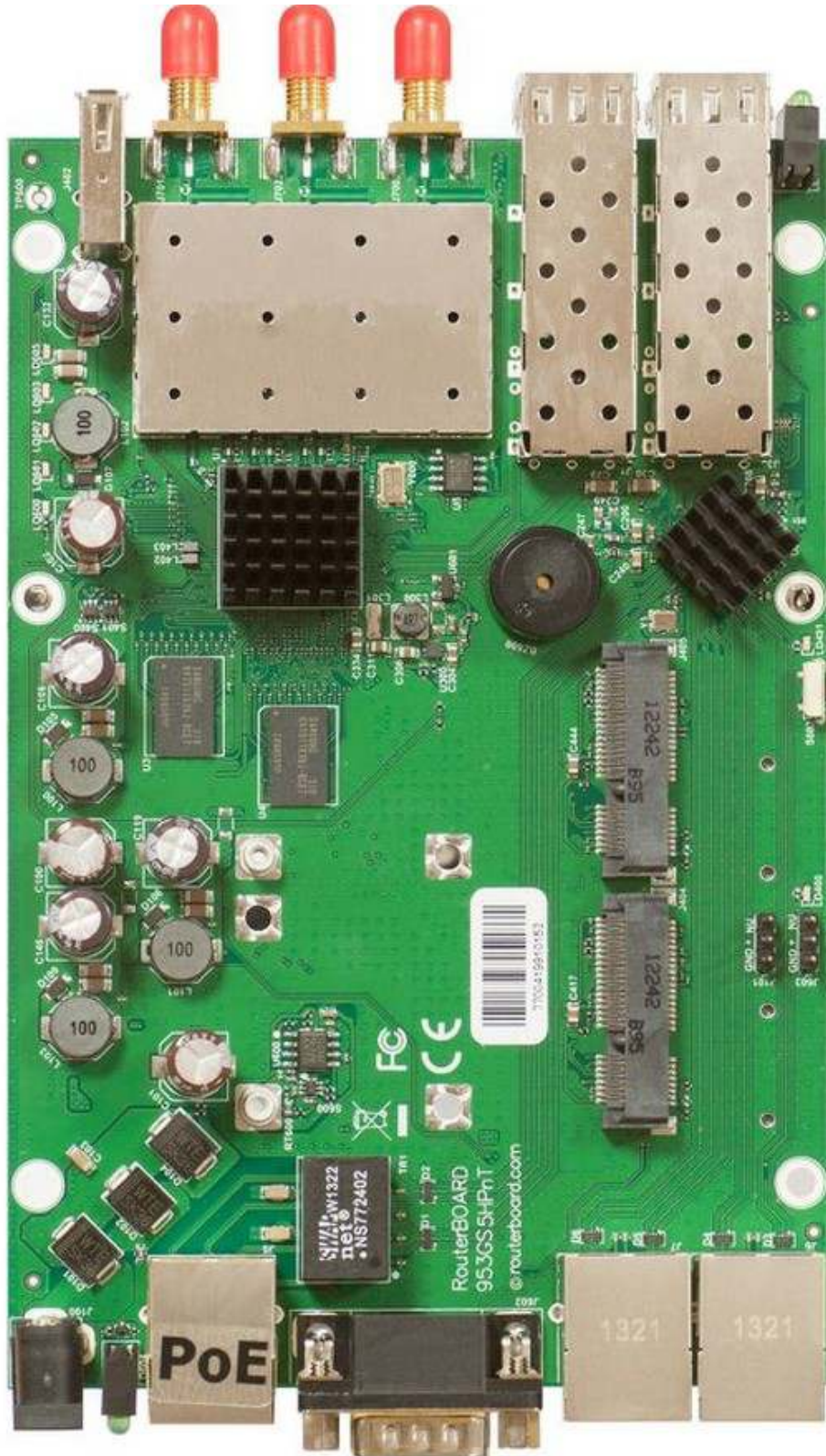

## Schottky diode measuring with multimeter in diode mode

Schottky diode reference numbers are D101, D102, D104; Voltage drop value should be about 0,197V



## Voltage drop between diode array pin#1 and Ground.

Check voltage drop between TR1 Ethernet Transformers pins and Ground. Ether Pins are marked with red circles.

It should be in the range from 0,32V to 0,589V

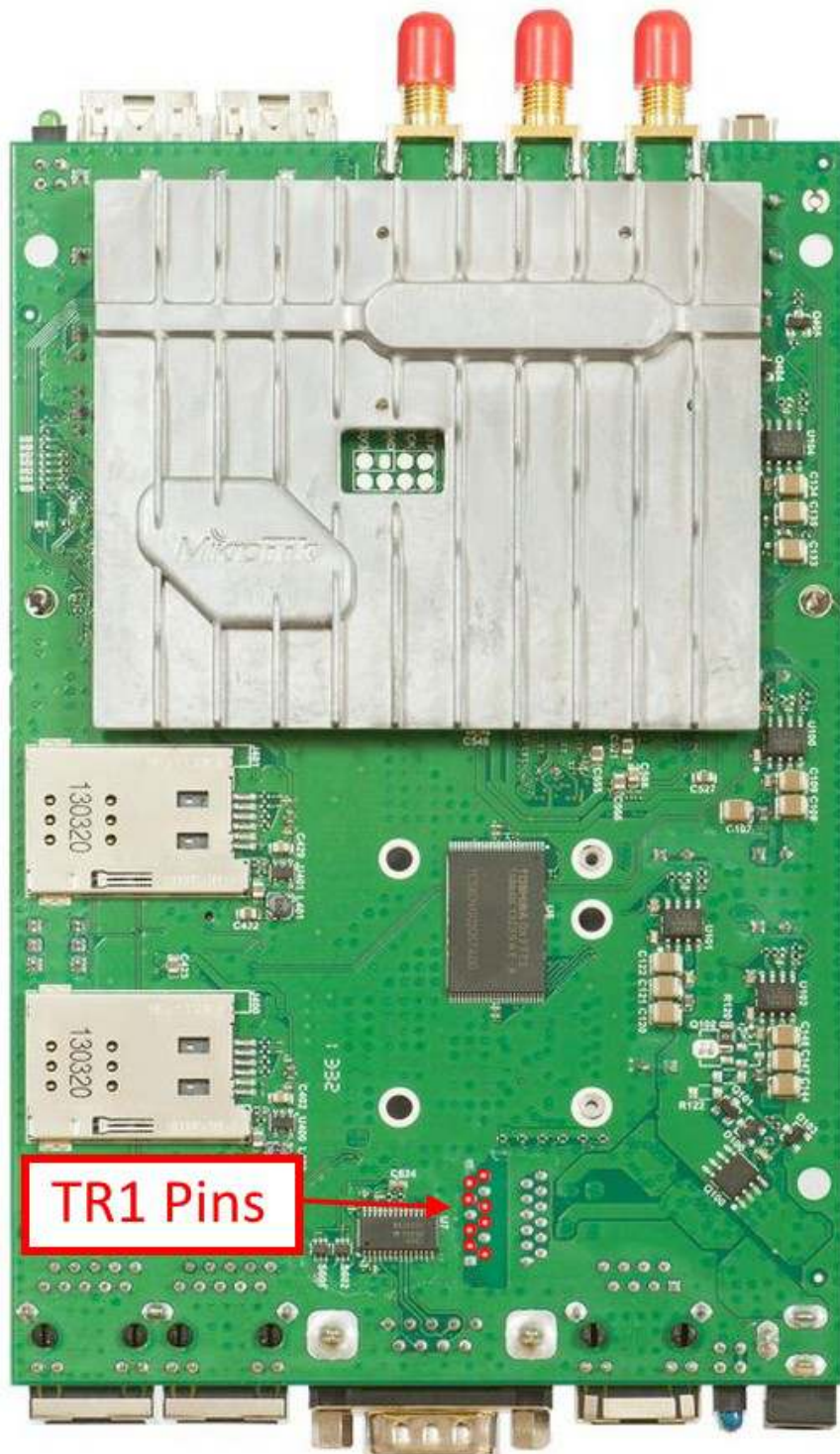

## 75R Termination resistors resistance.

Resistor resistance, marked with red arrow, should be 75 Ohm +/- 1%

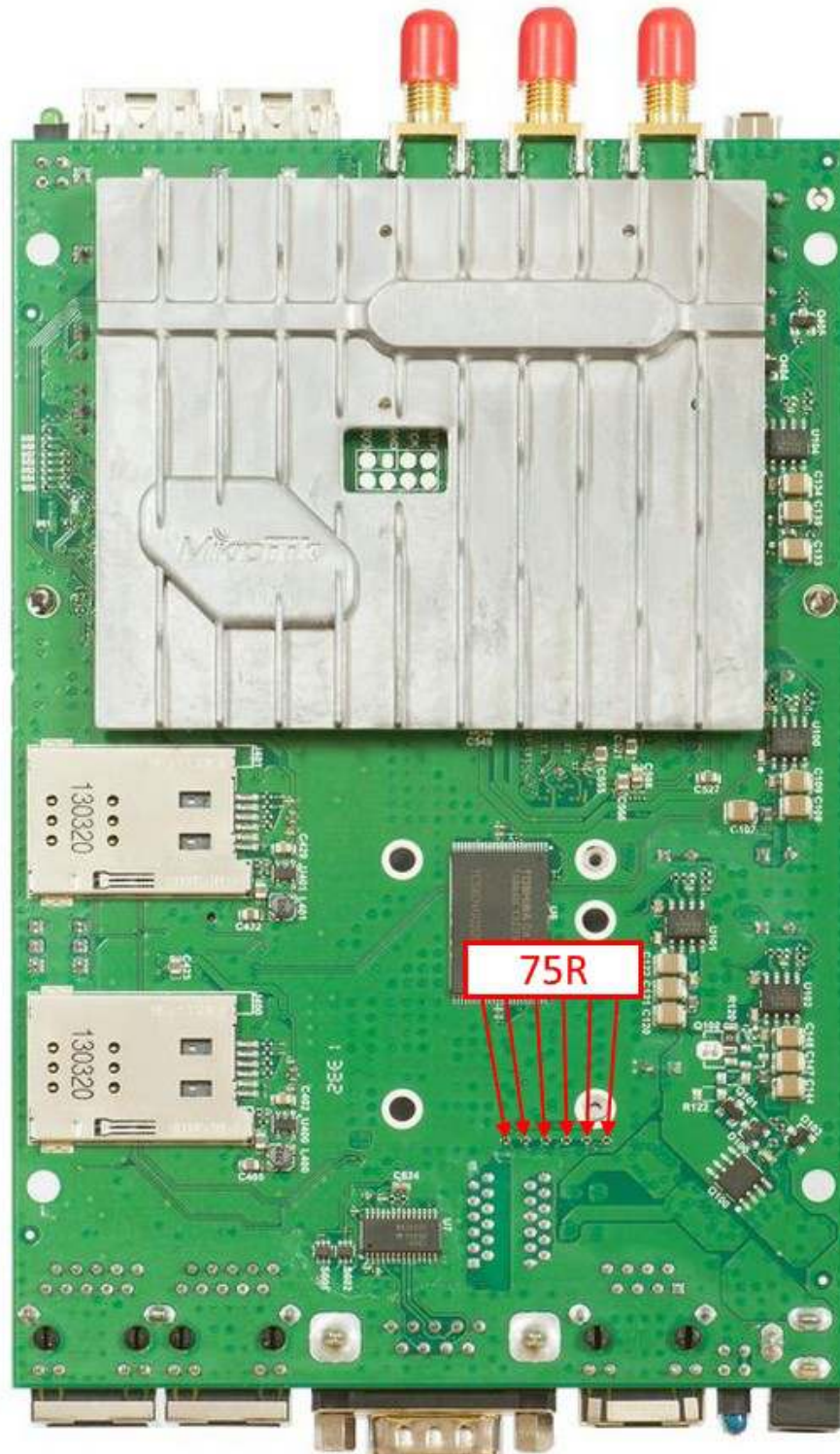



On ports Ether2 – Ether3 You can take patch cord and plug it into the routerboard, and then measure resistance of termination resistors.

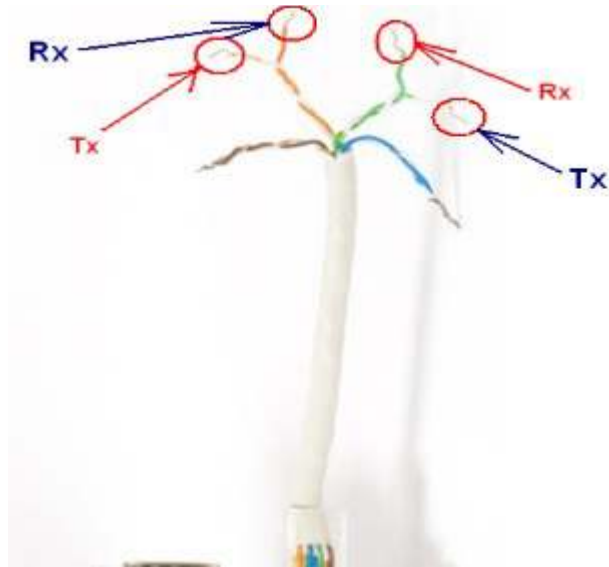

Resistance value between Rx and Tx line must be 150 Ohm  $\pm 4\%$ .

If resistance value is smaller or higher then Tx/Rx line was damaged by high voltage surge.

# RB50Gx2 series RouterBoards

## RB50Gx2

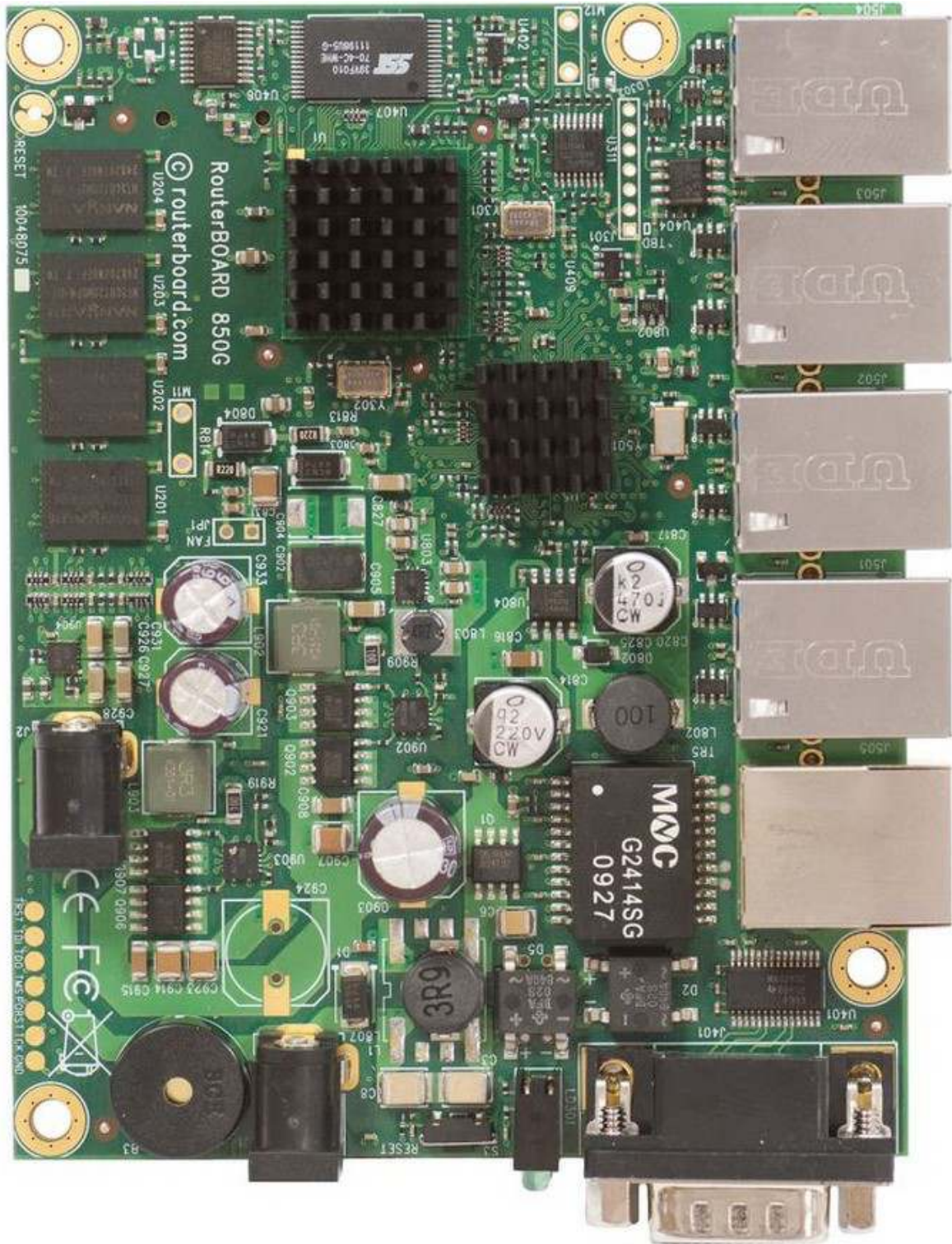

## Schottky diode measuring with multimeter in diode mode

Schottky diode reference number is D1; Voltage drop value should be about 0,225V

Diode bridge reference numbers are D2 and D5. Voltage drop value should be about 0,675V

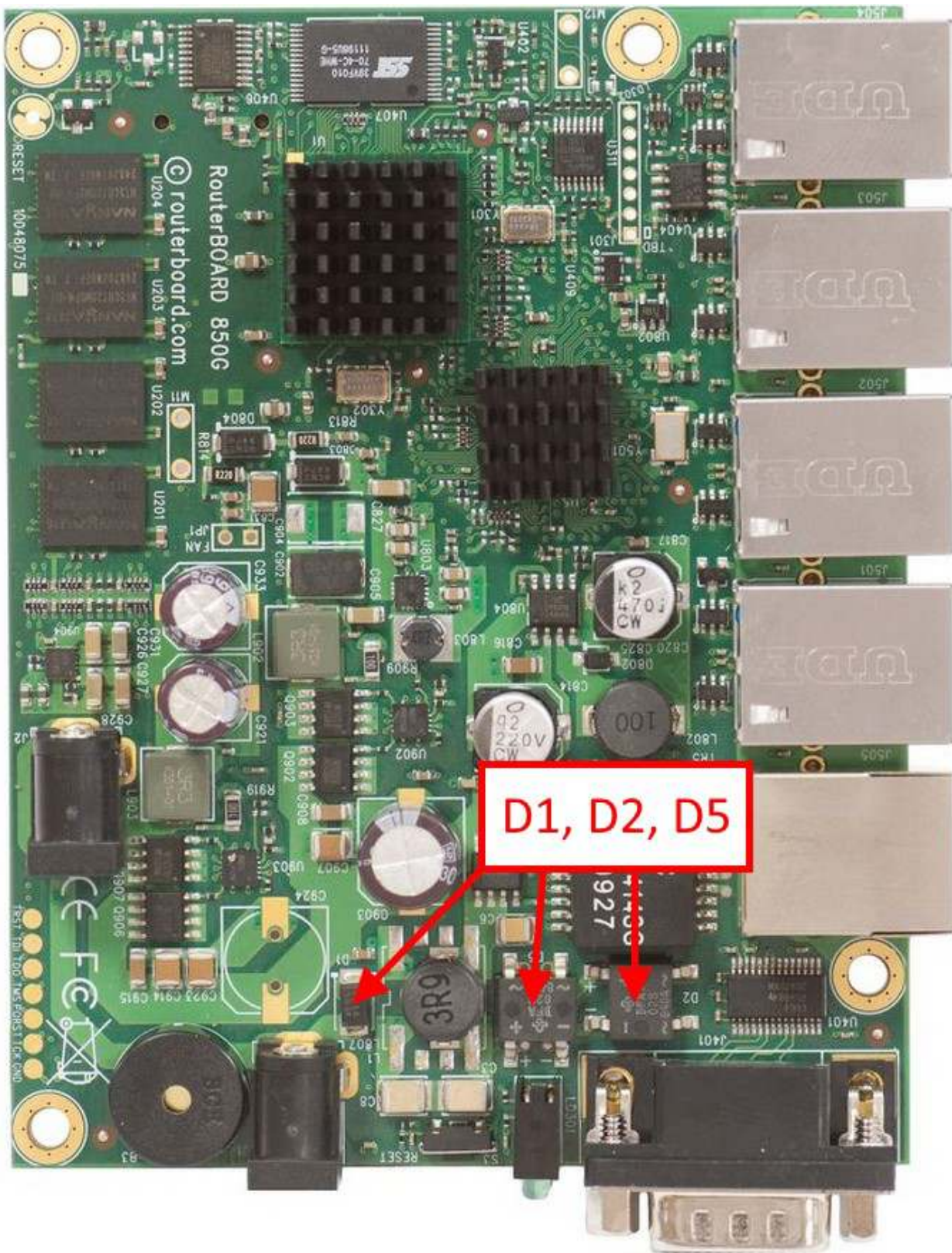

## Voltage drop between diode array pin#1 and Ground.

Check voltage drop between TR5, ether2- ether5 Transformers pins and Ground. Ether Pins are marked with red arrows and circles.

It should be in the range from 0,32V to 0,589V

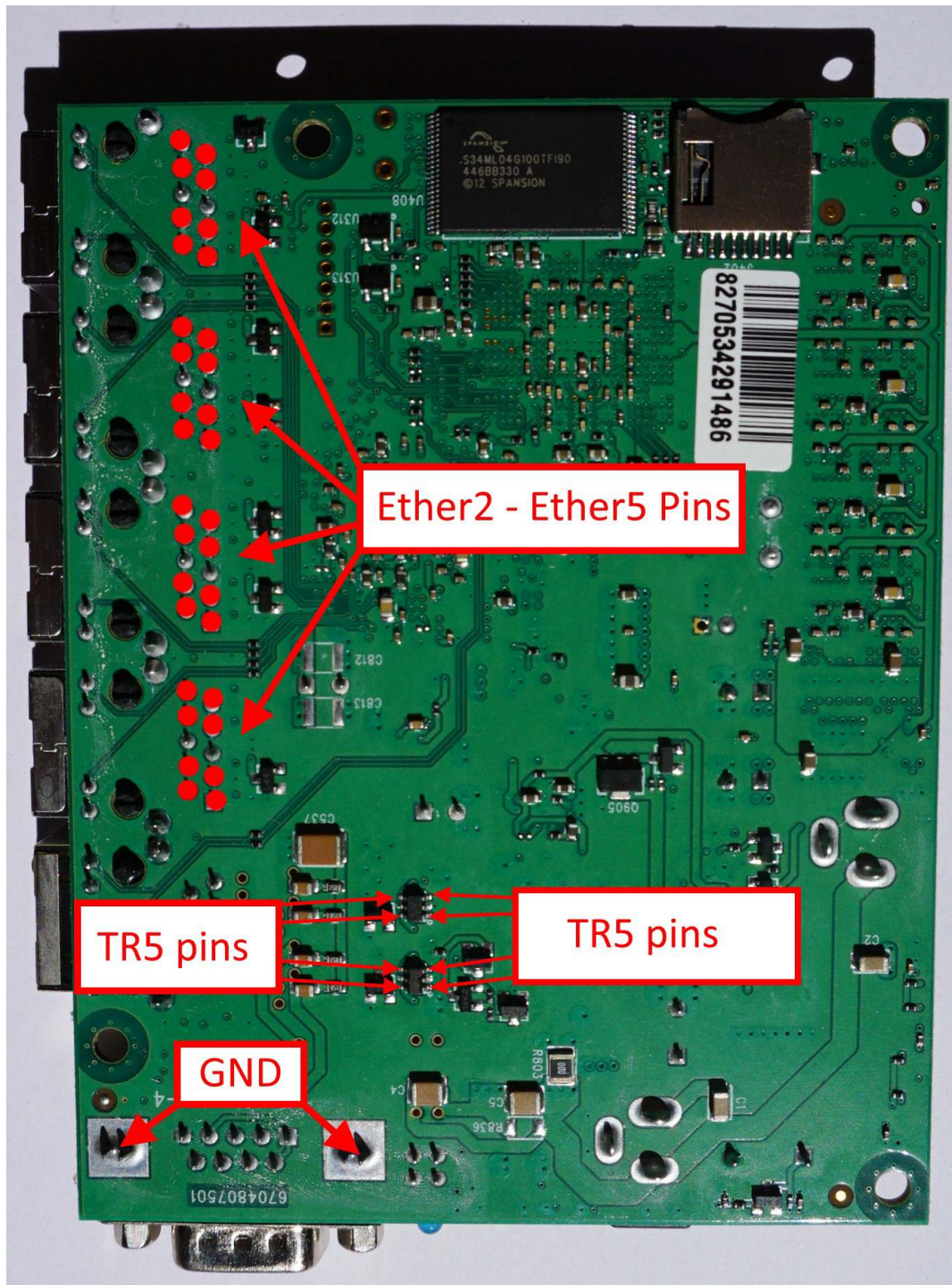

## 75R Termination resistors resistance.

Resistor resistance, marked with red arrow, should be 75 Ohm +/- 1%

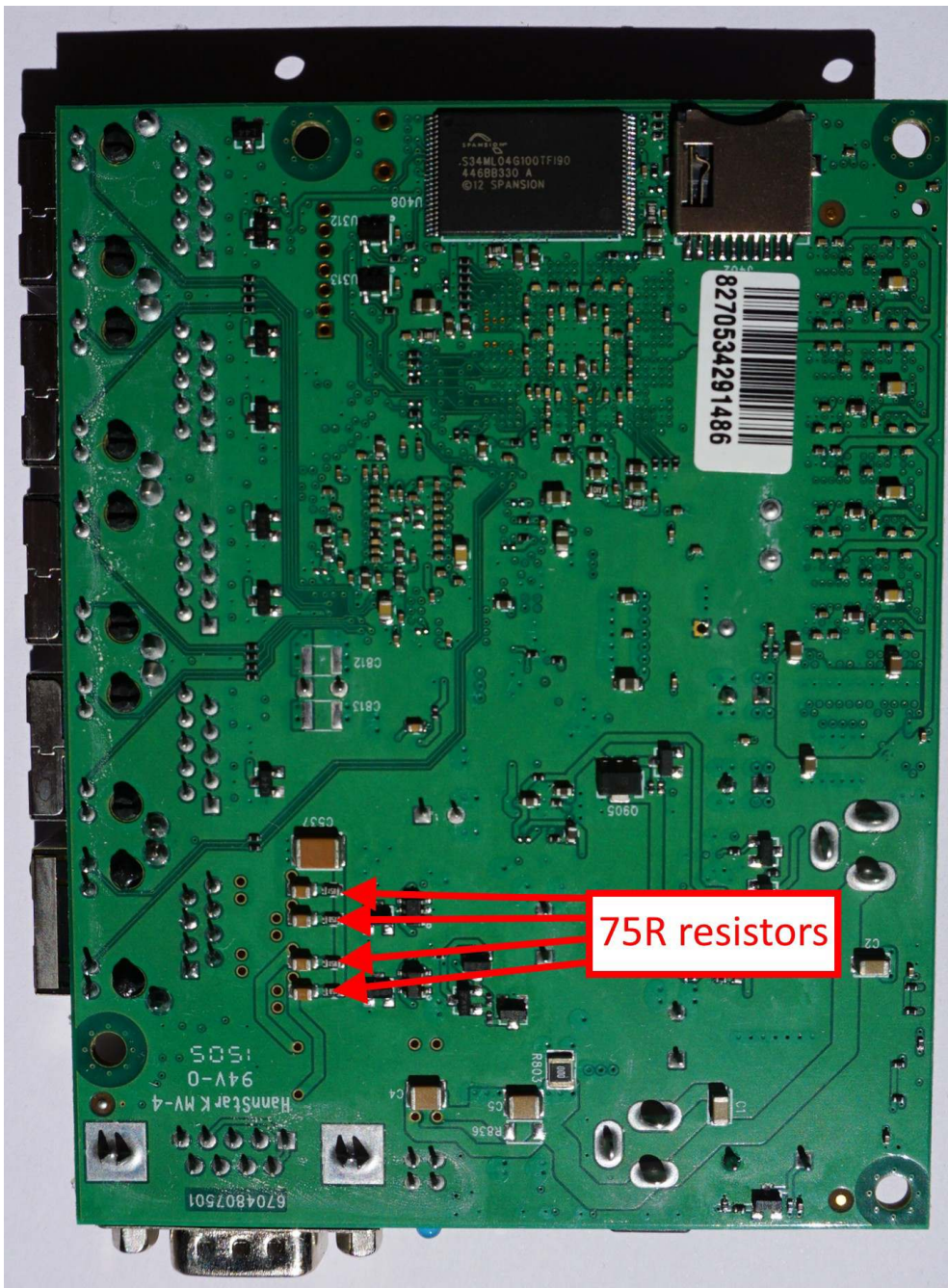

On ports Ether2 – Ether5 You can take patch cord and plug it into the routerboard, and then measure resistance of termination resistors.

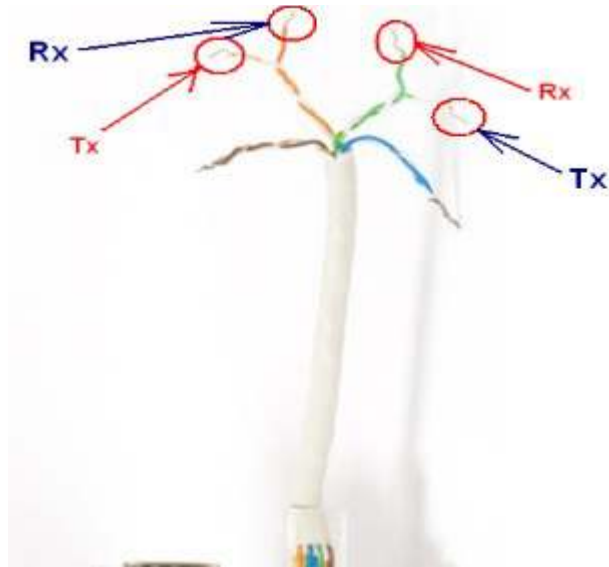

Resistance value between Rx and Tx line must be 150 Ohm  $\pm 4\%$ .

If resistance value is smaller or higher then Tx/Rx line was damaged by high voltage surge.



# RB911G-2HPnD

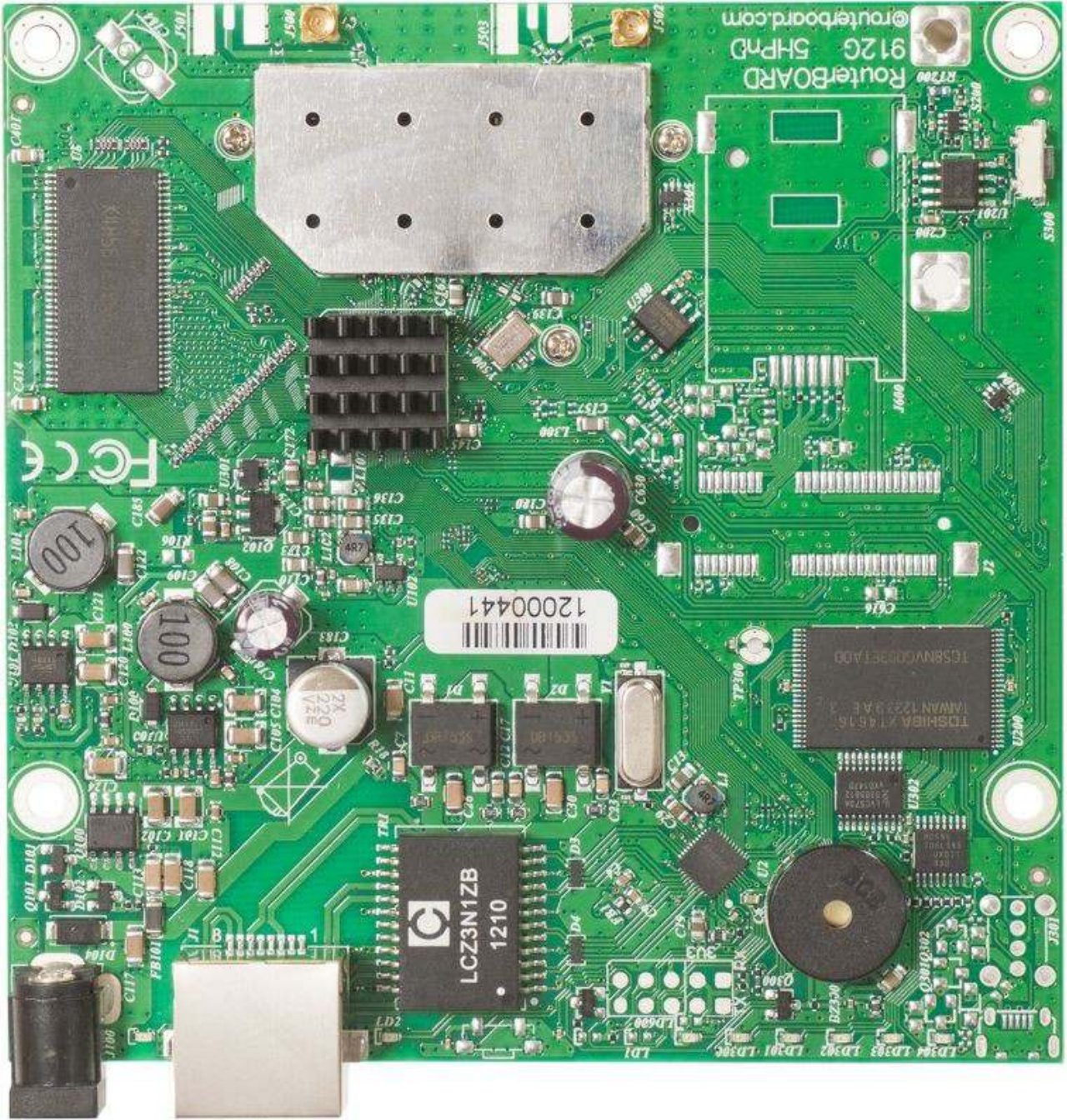



## BaseBox 2



## BaseBox 2 disassembling information

### 1. step

Remove the sticker from connectors



### 2. step

Remove the screw stickers



3. step

Unscrew the case base from the board holder with torque screwdriver T8



4. step

Remove the case base from the board holder



## Schottky diode measuring with multimeter in diode mode

Schottky diode reference number is D104; Voltage drop value should be about 0,350V

Diode bridge reference numbers are D1 and D2. Voltage drop value should be about 0,563V

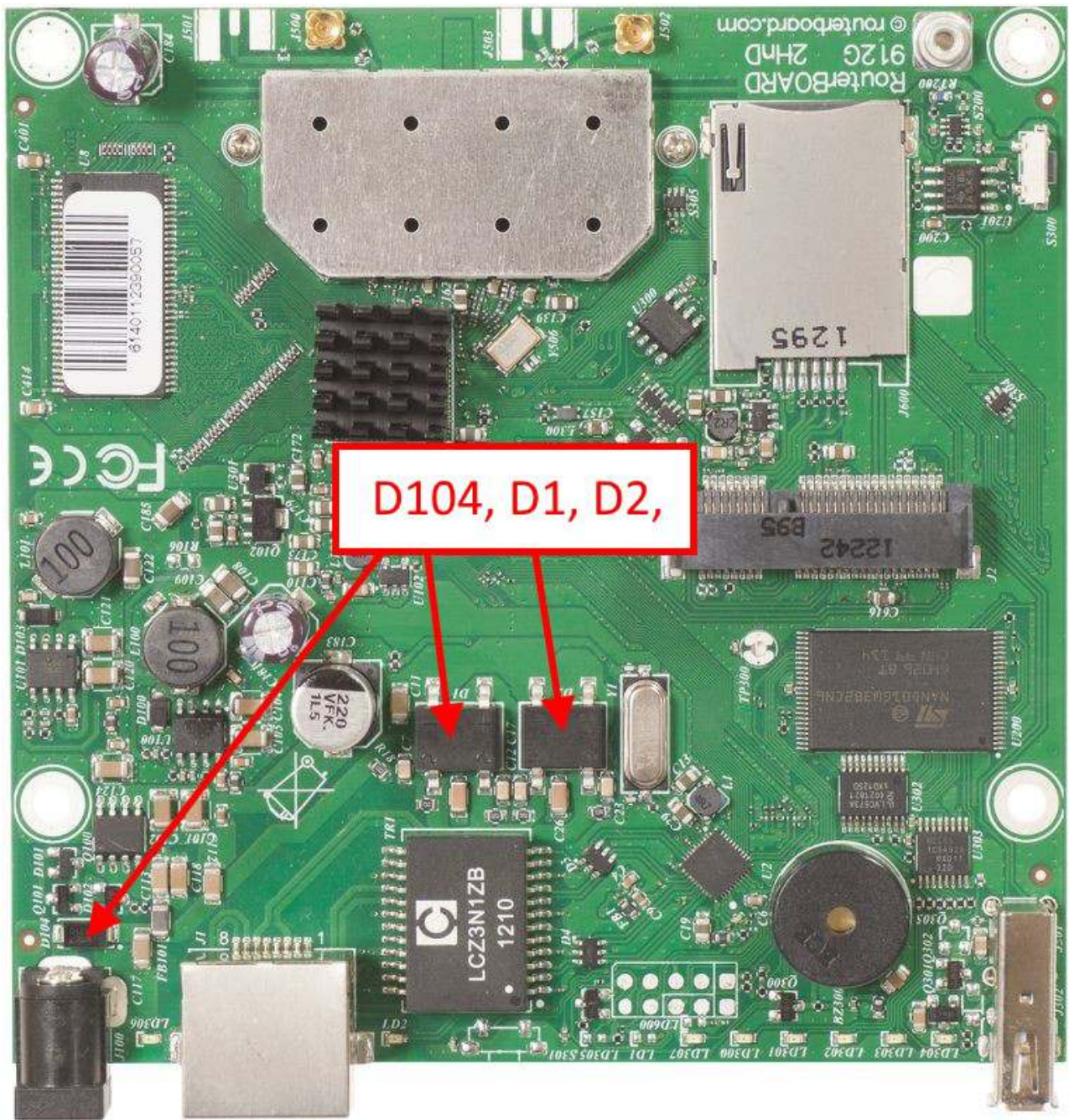

## Voltage drop between diode array pin#1 and Ground.

Check voltage drop between TR1, Transformers pins and Ground. Ether Pins are marked with red arrows.

It should be in the range from 0,32V to 0,589V

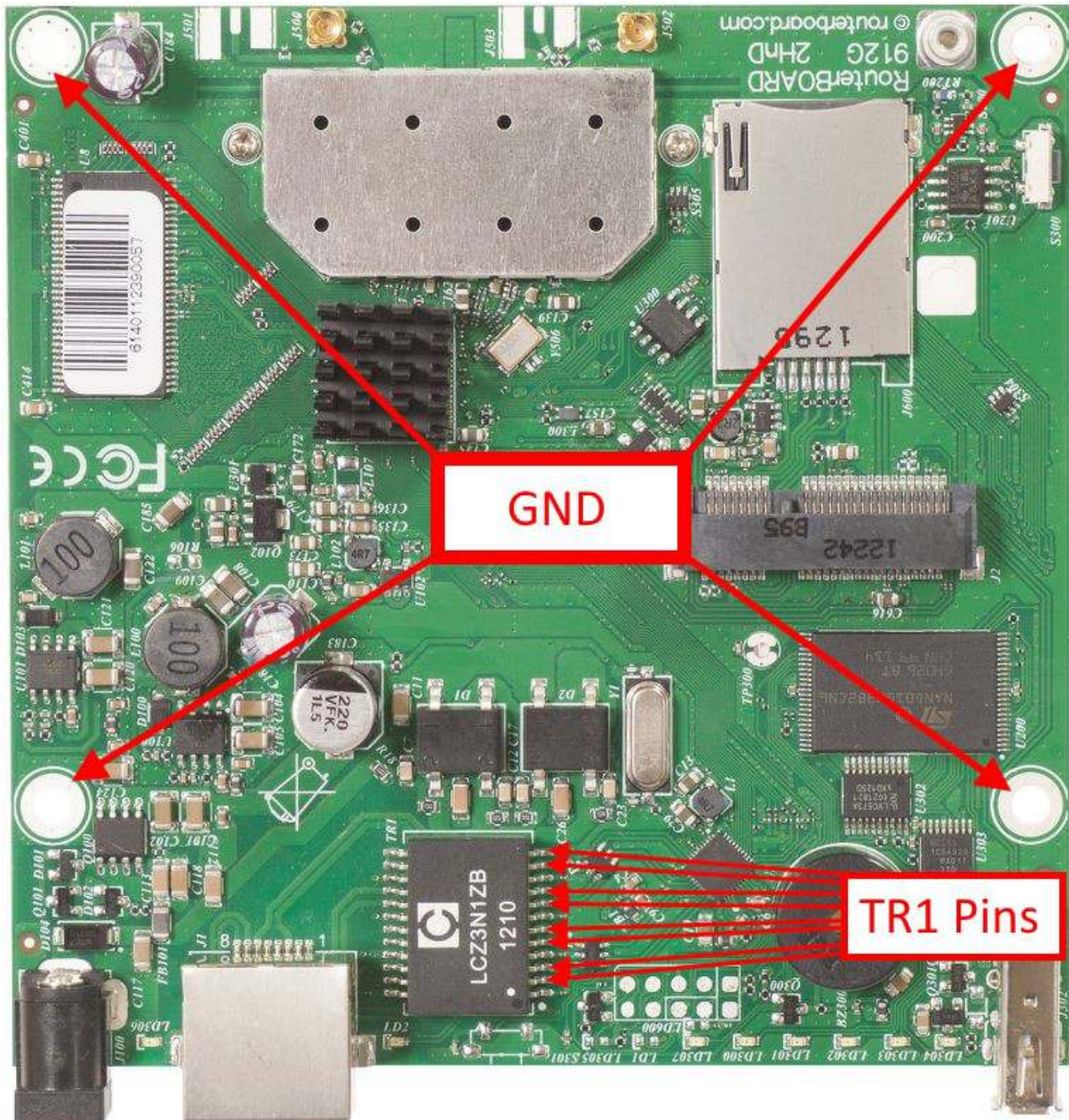

## 75R Termination resistors resistance.

Resistor resistance, marked with red arrow, should be 75 Ohm +/- 1%

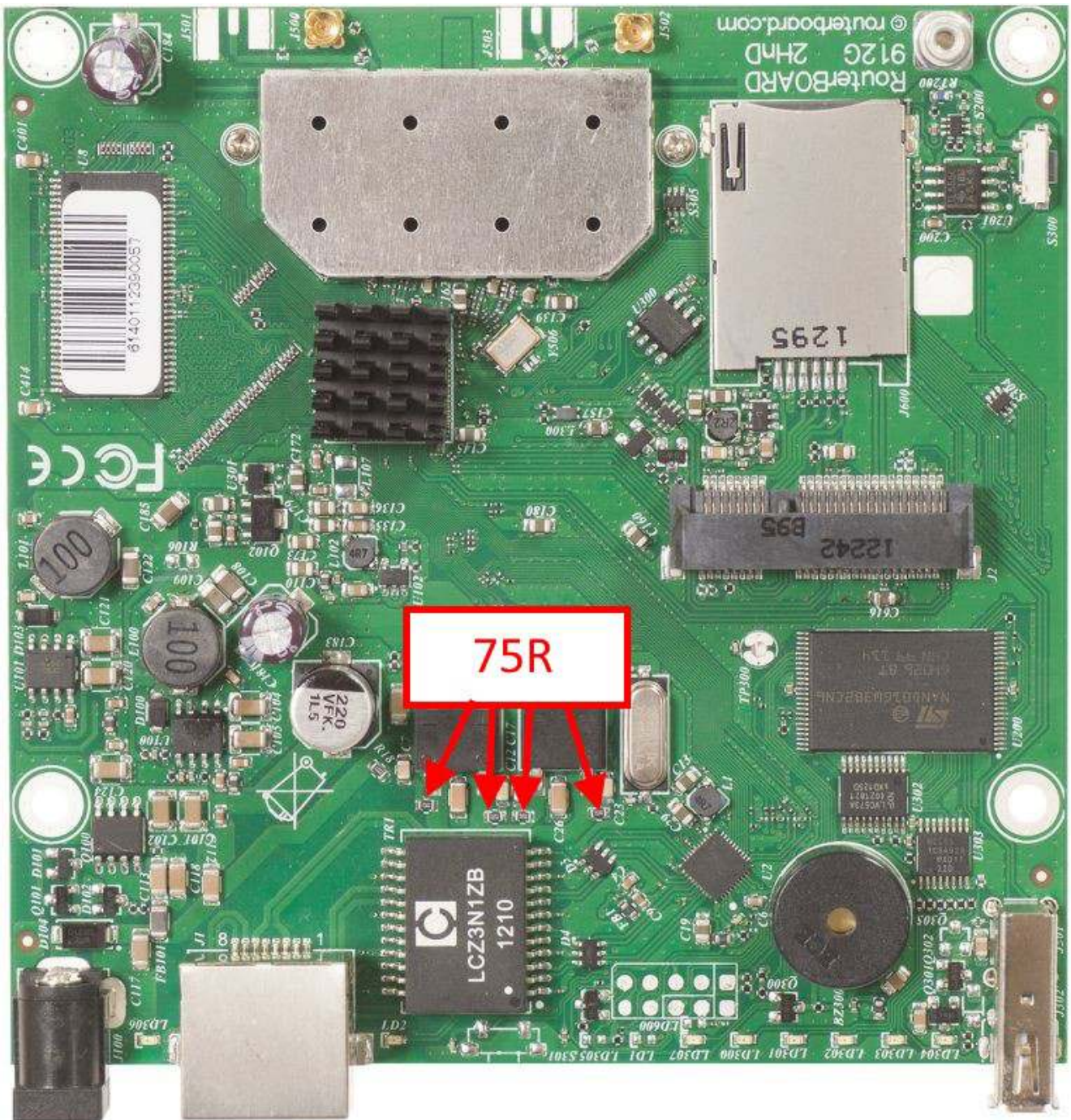

## RB912G - 5HPnD series RouterBoards

### RB912UAG-5HPnD

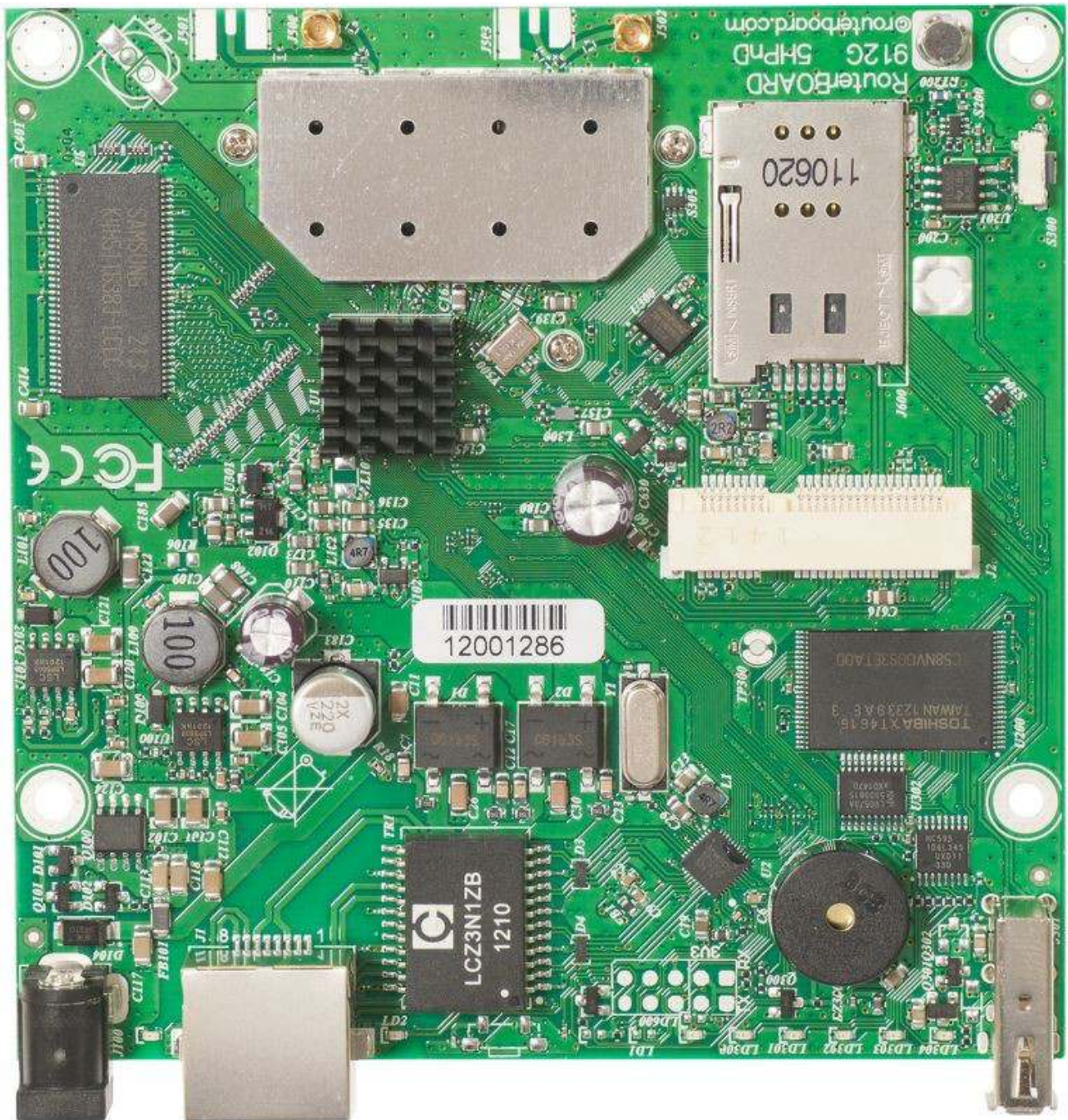

## SEXTANT G 5HPnD





## BaseBox 5



## QRT 5



## QRT 5 disassembling information

### 1. step

Remove the wing nut from Ground M4 screw

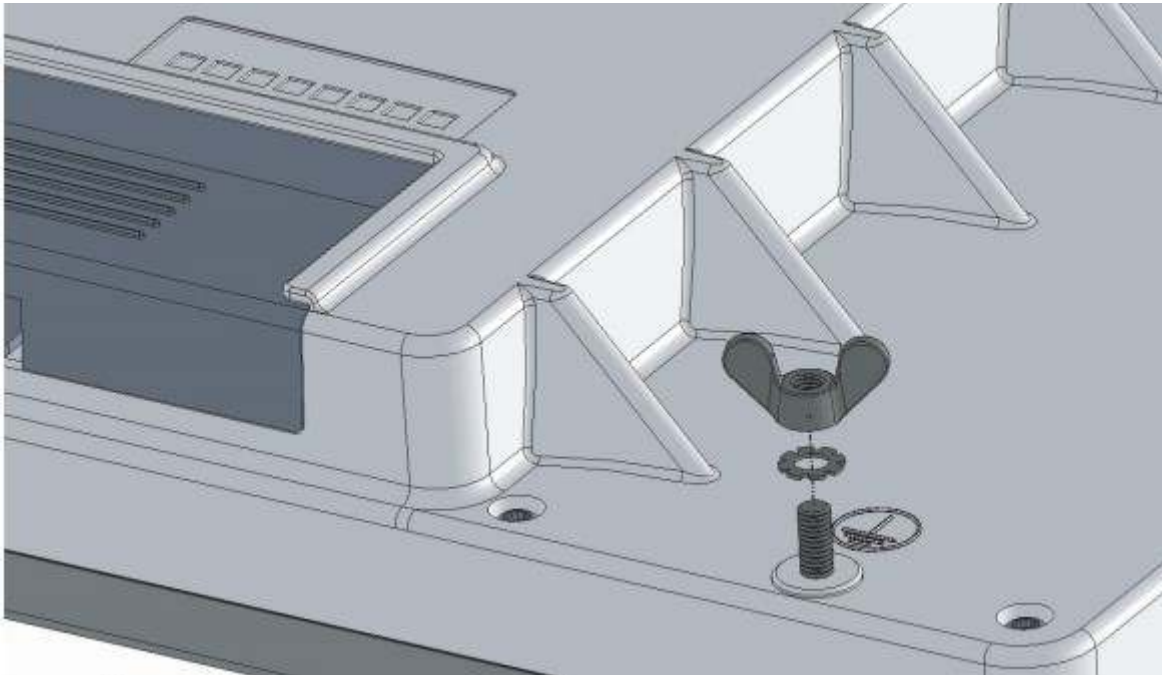

### 2. step

Remove the 12 pcs screws with torque screwdriver T8

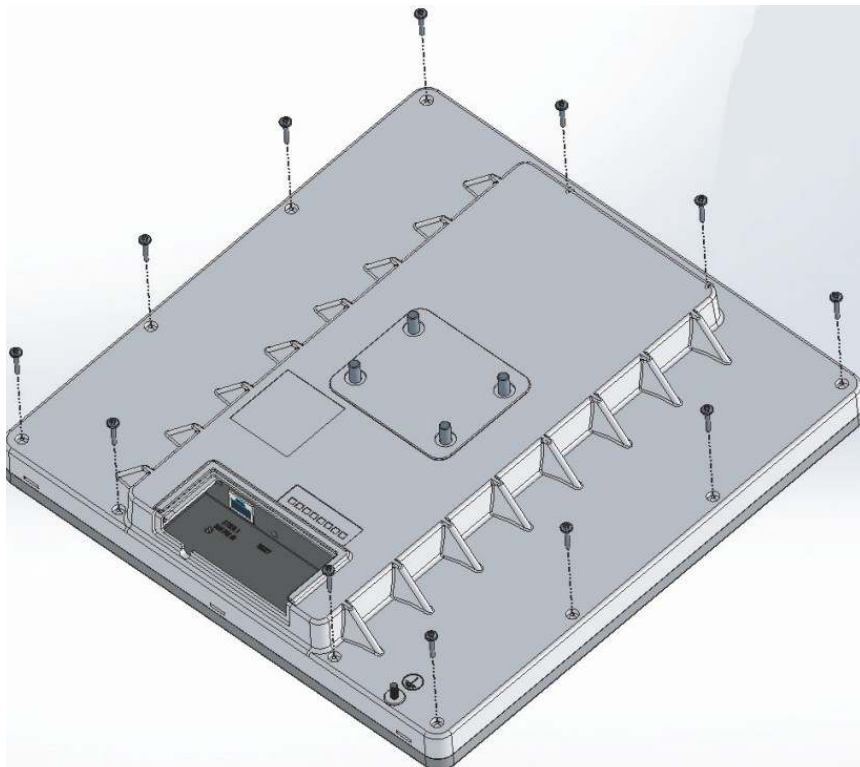

3. step

Remove the cover

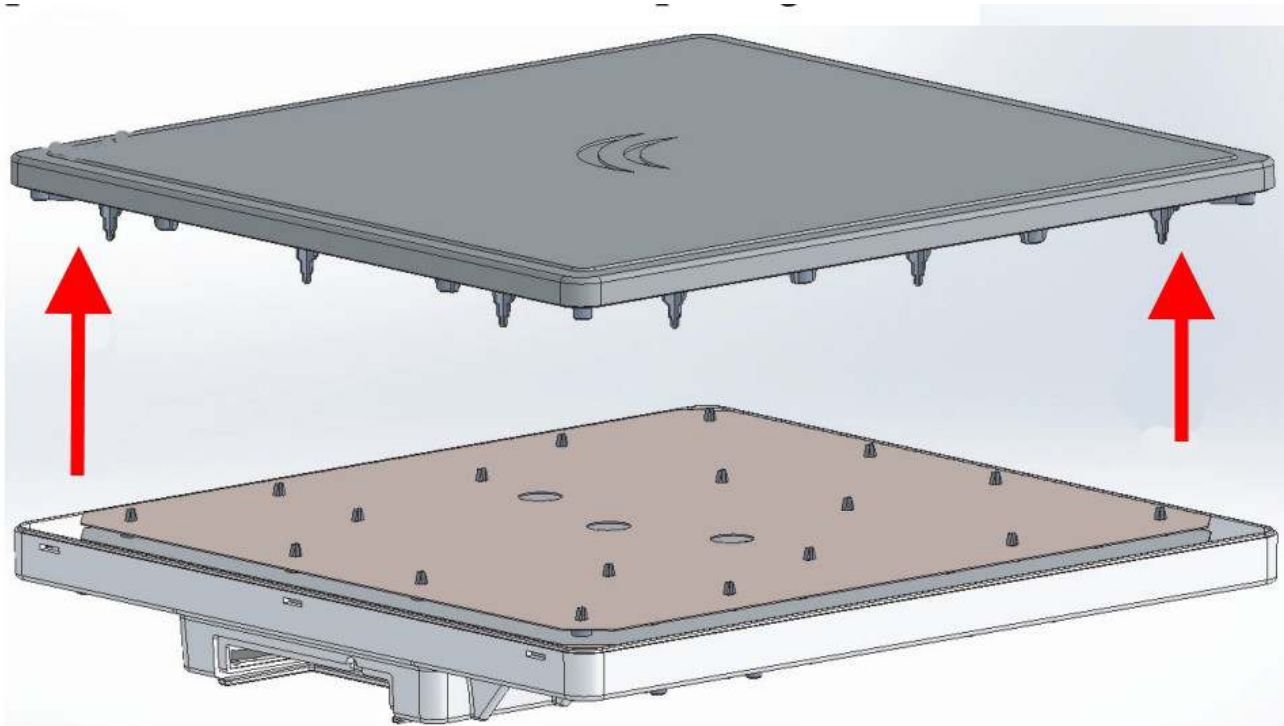

4. step

Remove the M4 screw from bottom plate and than separate bottom plate from antenna with board.

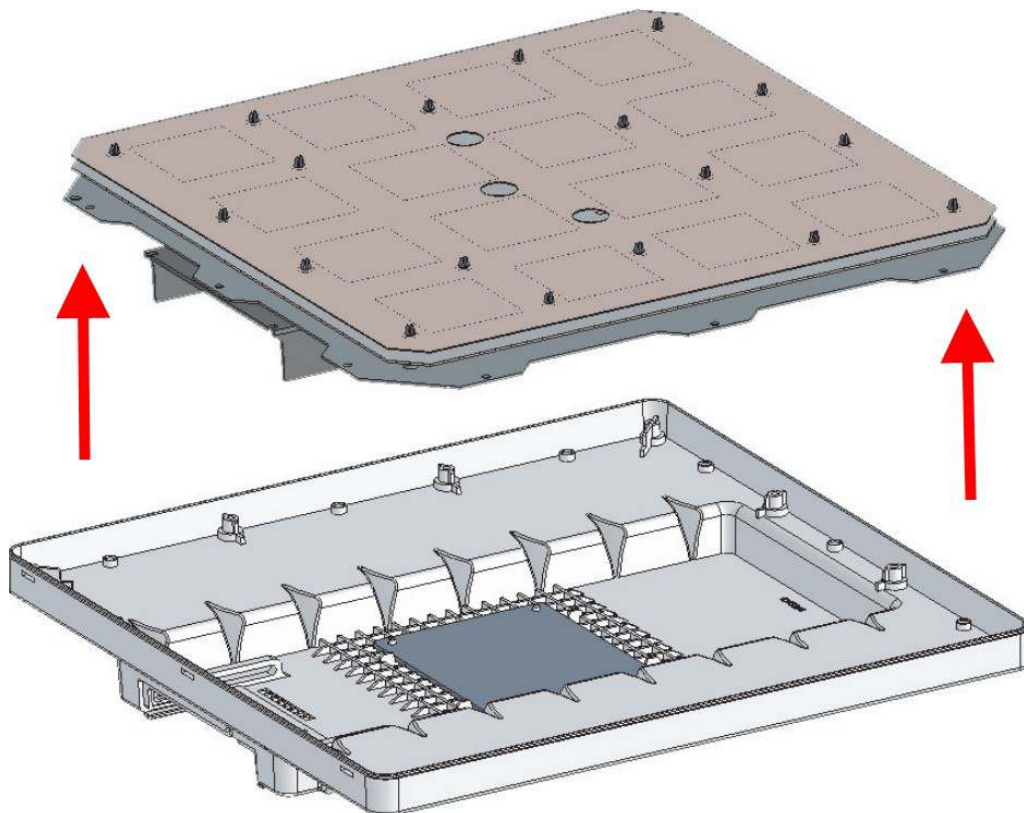

## BaseBox 5 disassembling information

### 1. step

Remove the sticker from connectors



### 2. step

Remove the screw stickers



3. step

Unscrew the case base from the board holder with torque screwdriver T8



4. step

Remove the case base from the board holder

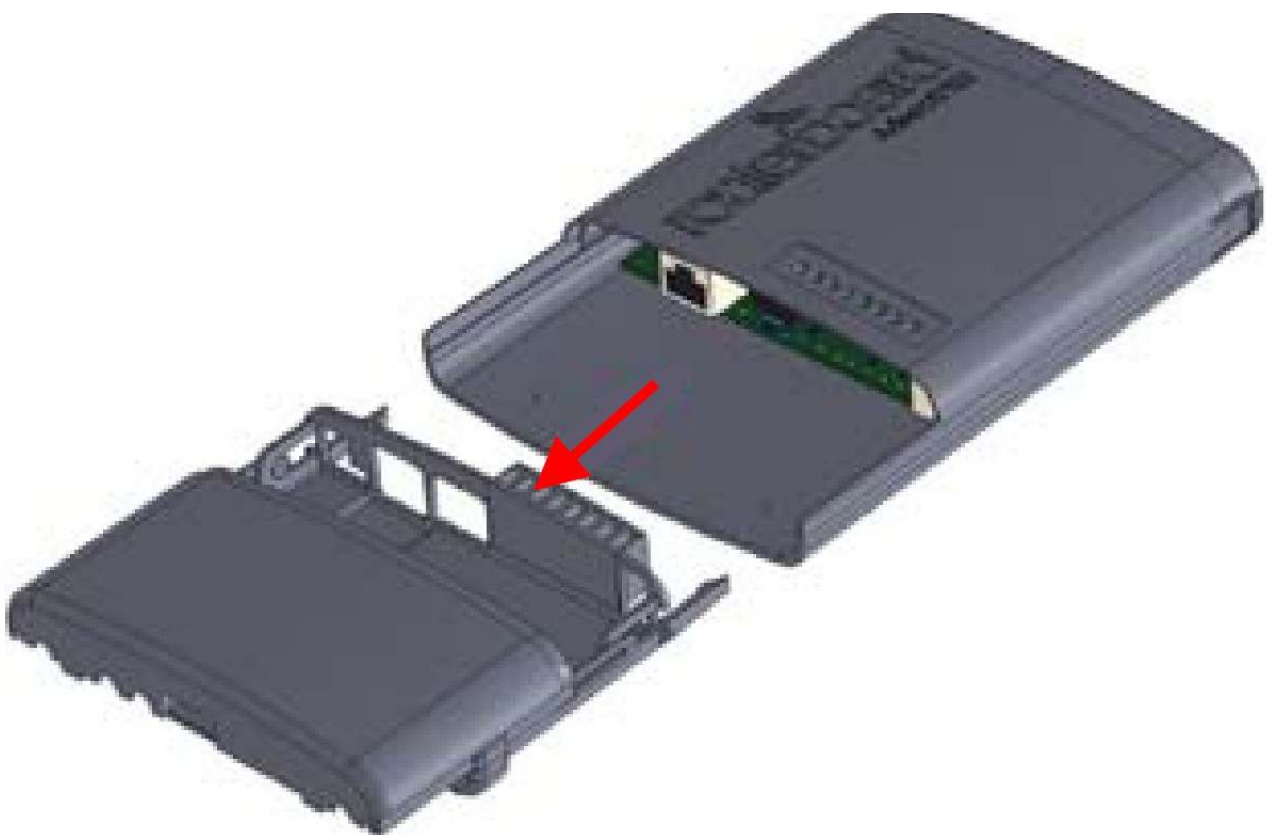

## Schottky diode measuring with multimeter in diode mode

Schottky diode reference number is D104; Voltage drop value should be about 0,350V

Diode bridge reference numbers are D1 and D2. Voltage drop value should be about 0,563V

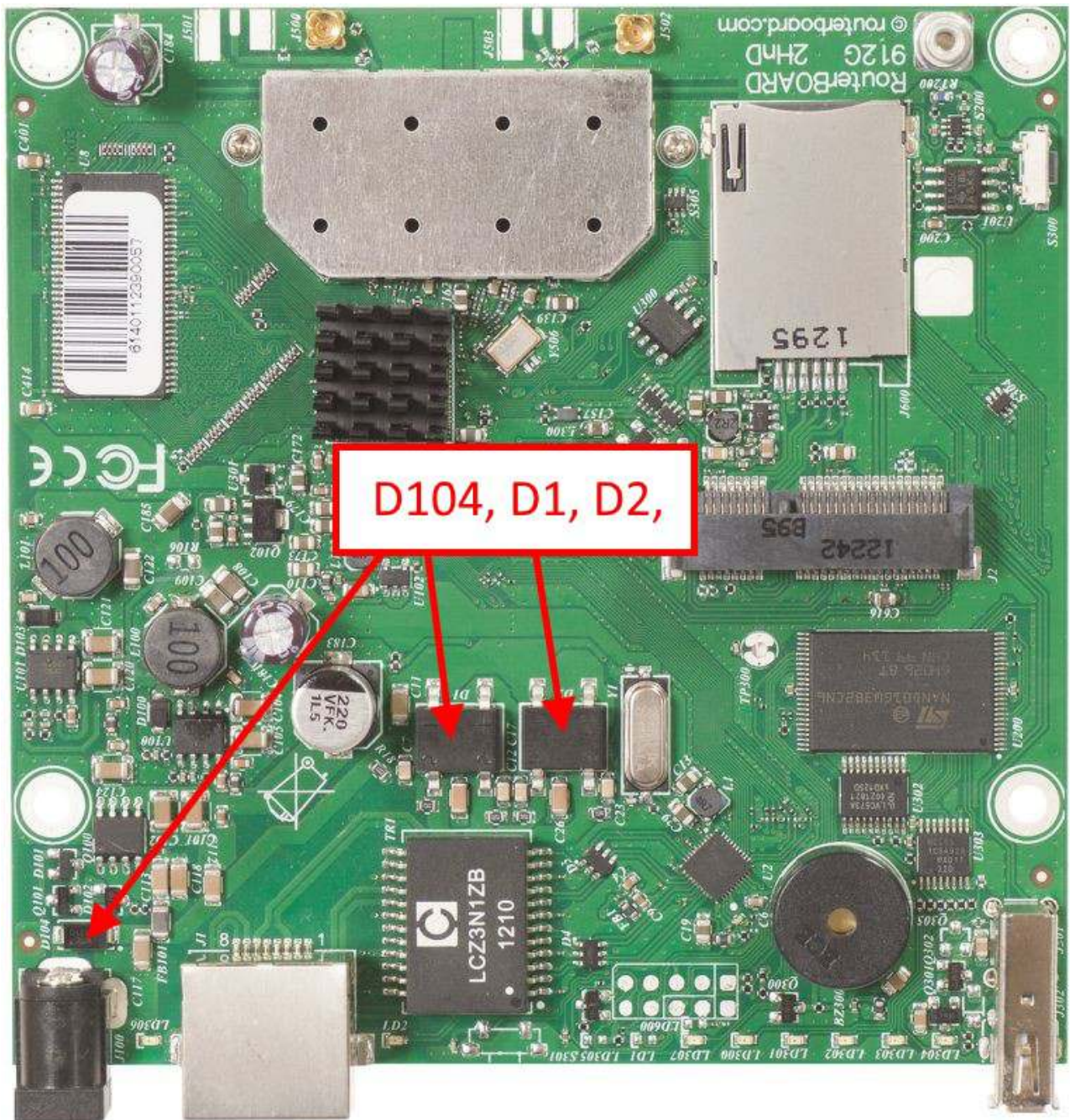

## Voltage drop between diode array pin#1 and Ground.

Check voltage drop between TR1, Transformers pins and Ground. Ether Pins are marked with red arrows.

It should be in the range from 0,32V to 0,589V

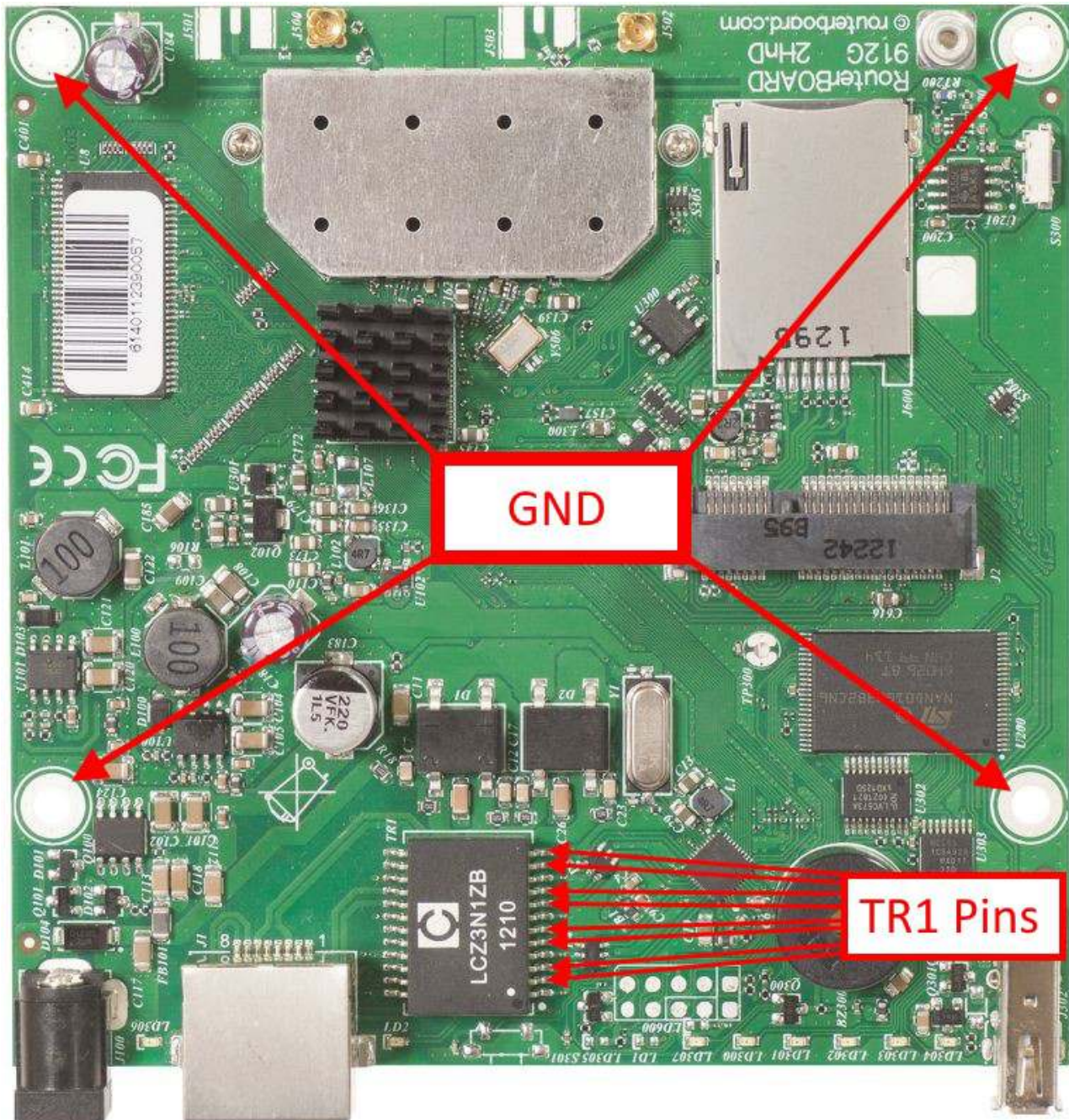



## 75R Termination resistors resistance.

Resistor resistance, marked with red arrow, should be 75 Ohm +/- 1%

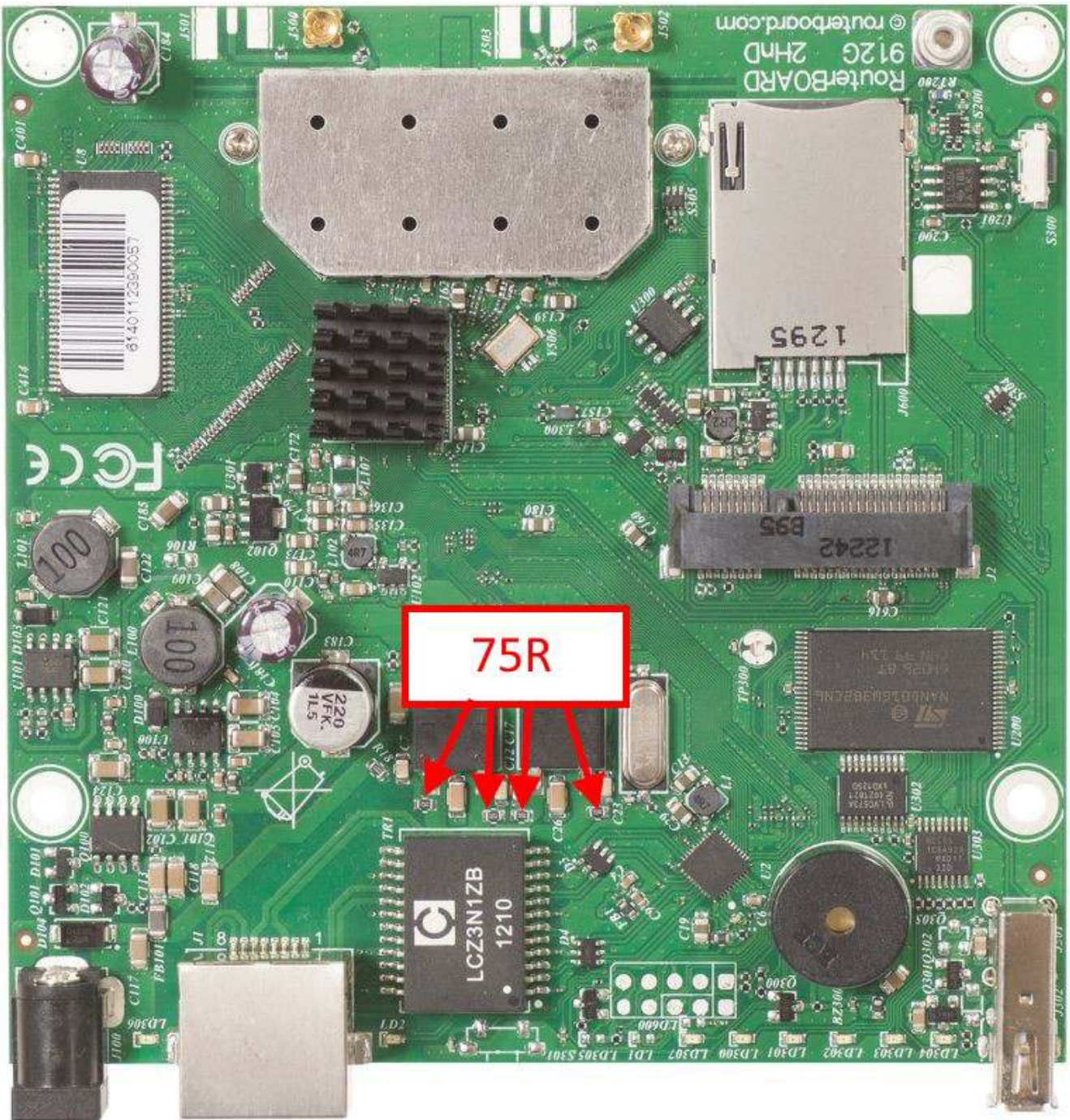

## **RBSXTG-5HPacD series RouterBoards**

---

**RBSXTG-5HPacD series:**

**SXT 5 ac**

**SXT SA5 ac**



**SXT HG5 ac**



## Disassembling information

### SXT series disassembling

#### 1. step

Use two “-” screwdrivers. Push screwdrivers in case cavities.

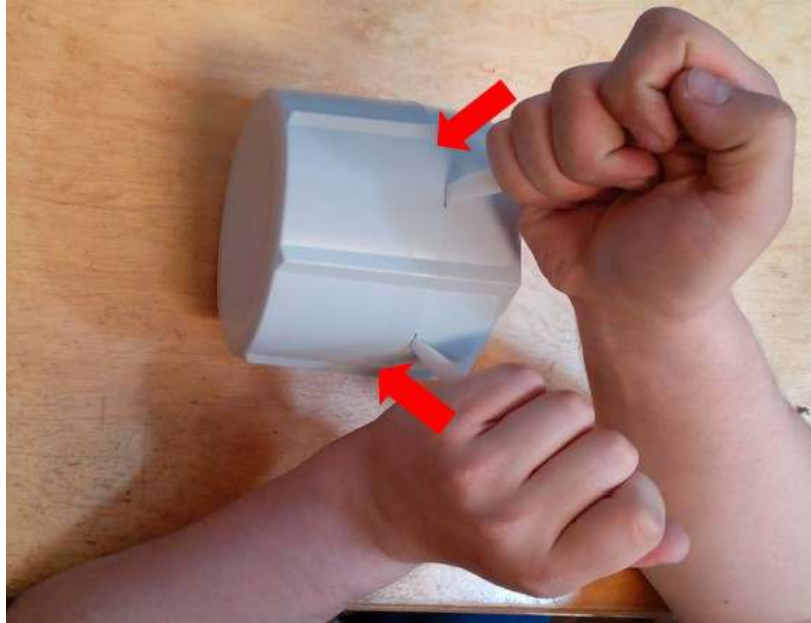

#### 2. step

Rotate screwdriver and pull both case parts.



3. step

Remove rubber bushing

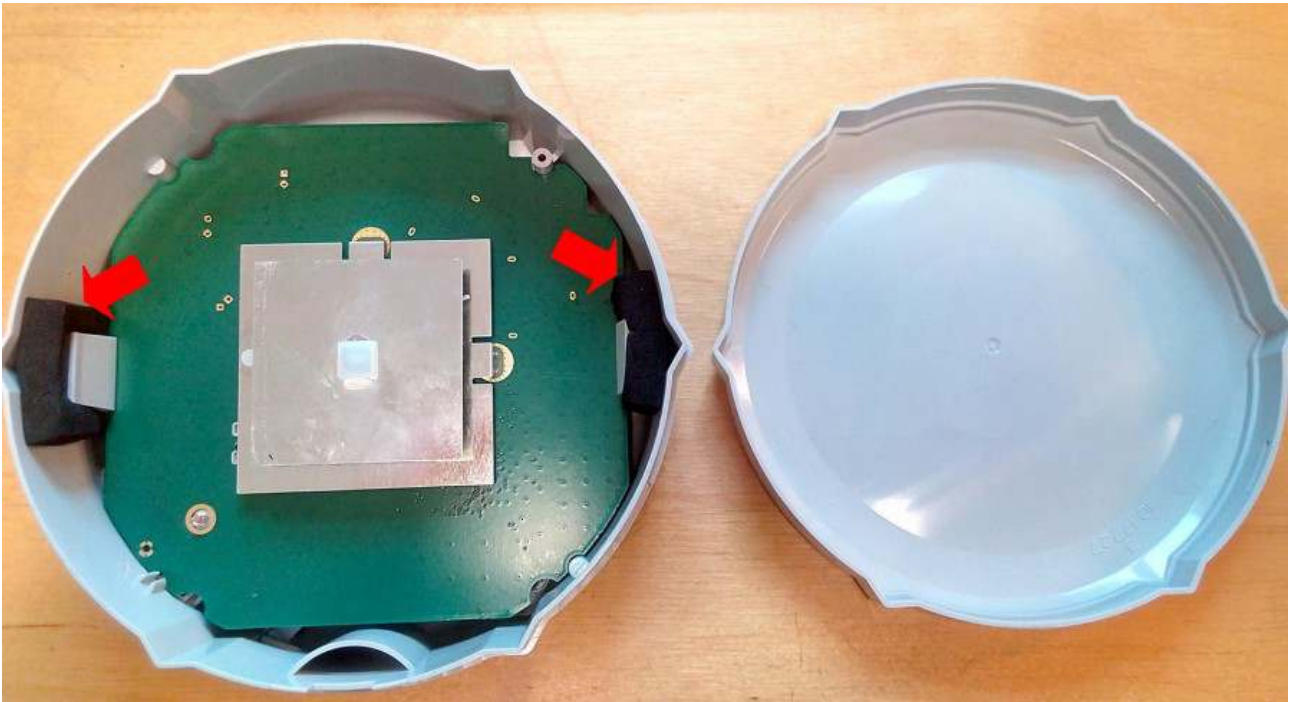

4. step

Push back Plastic PCB holders and take out the board.

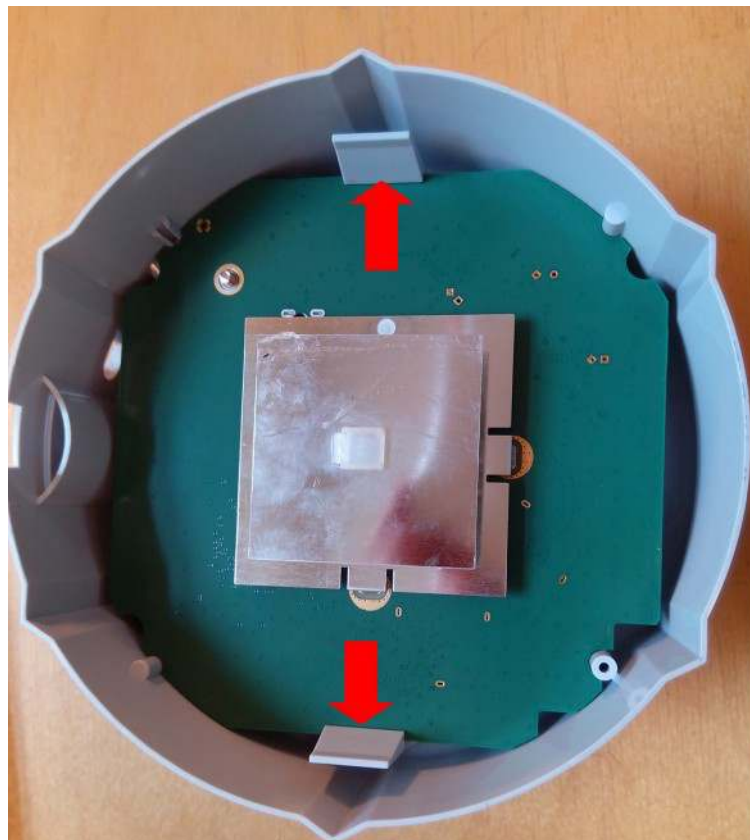

## Schottky diode measuring with multimeter in diode mode

Schottky diode reference numbers are D201, D203 . Voltage drop value should be about 0,170V

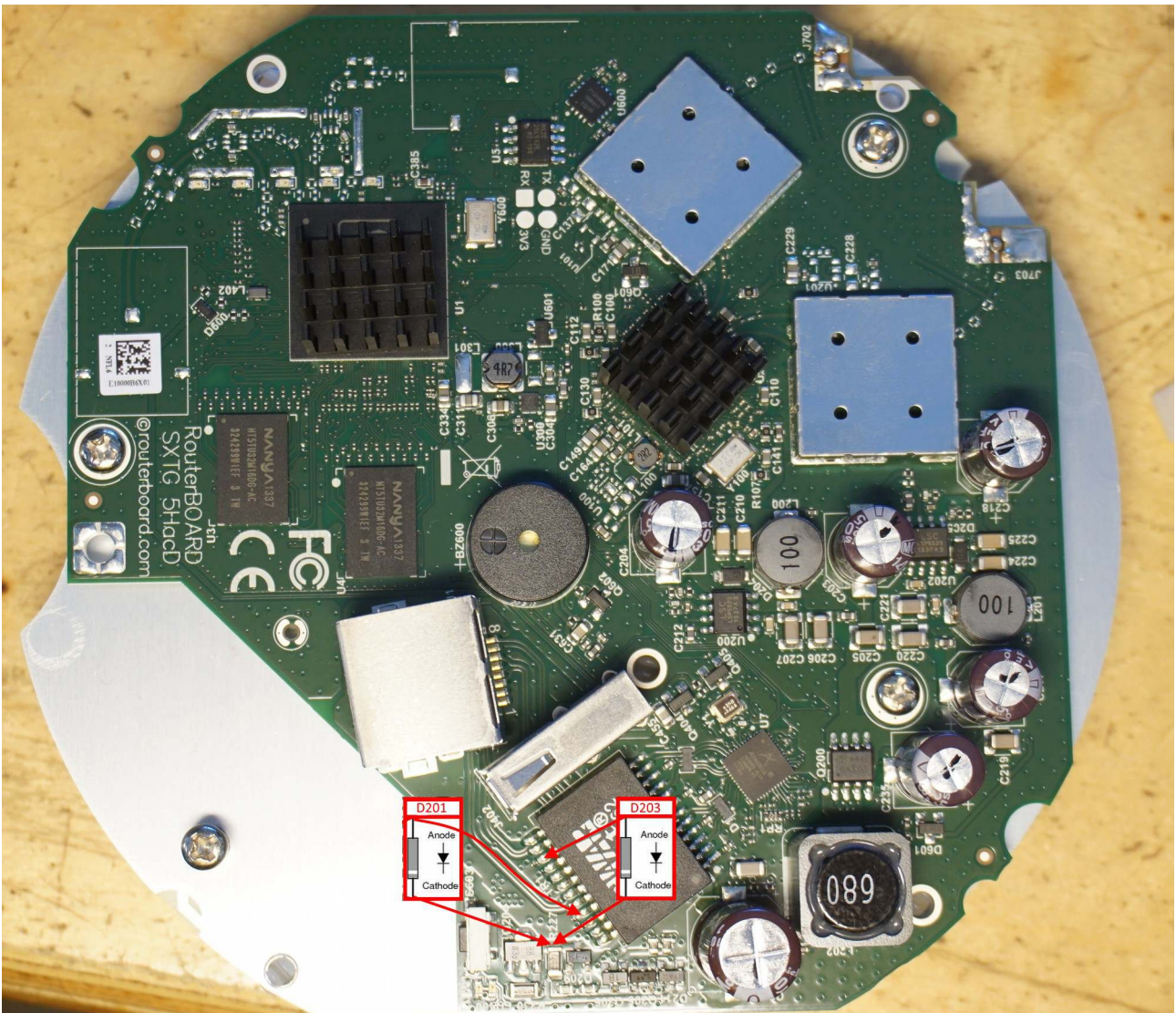

## Voltage drop between diode array pin#1 and Ground.

Check voltage drop between TRF1 Ethernet Transformers pins and Ground. Ether Pins are marked with red arrows.

It should be in the range from 0,32V to 0,48V

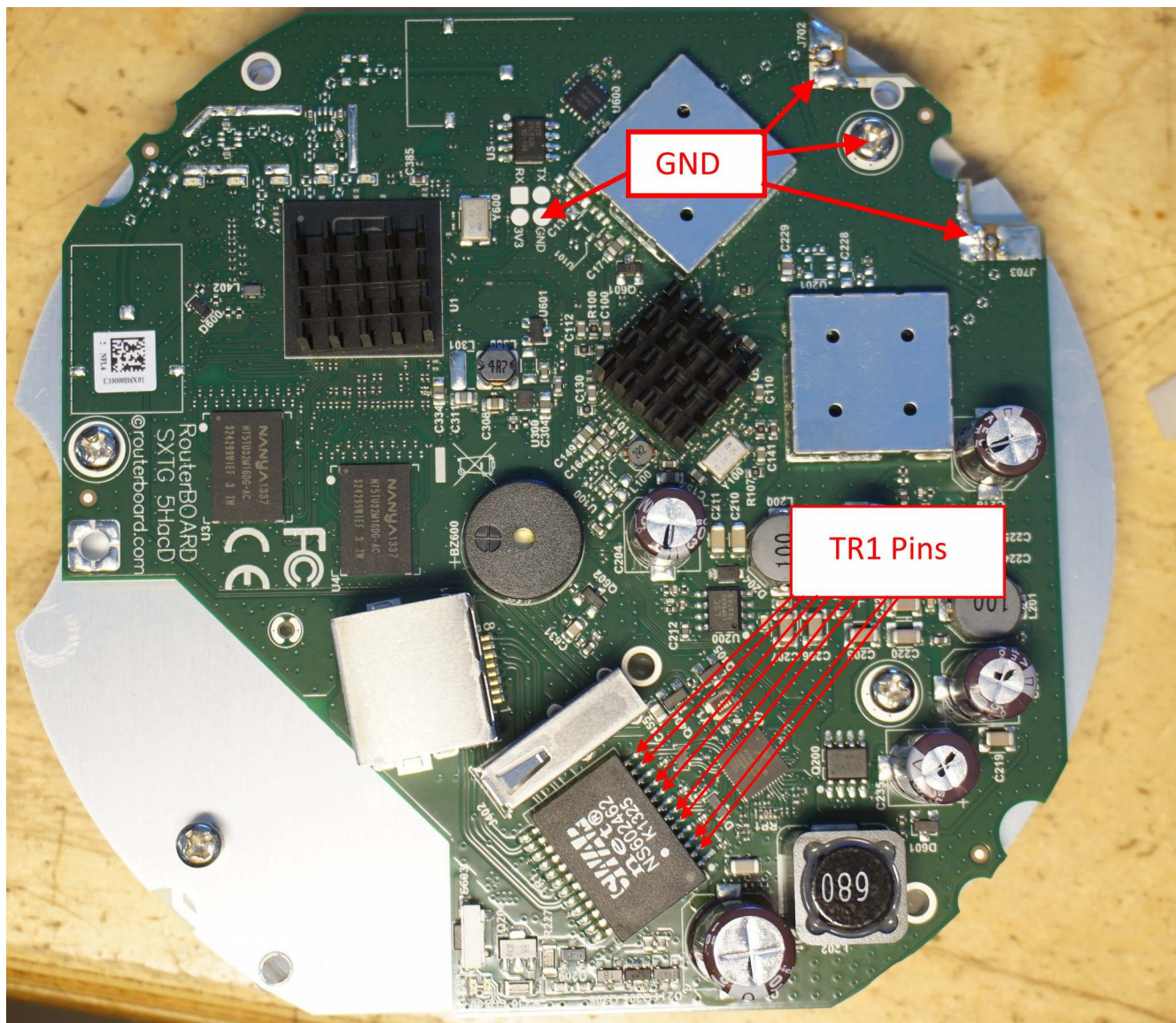

## RBSXTLite2 series RouterBoards

---

RBSXTLite2 series:

SXT Lite2



## Disassembling information

### SXT series disassembling

#### 1. step

Use two “-” screwdrivers. Push screwdrivers in case cavities.

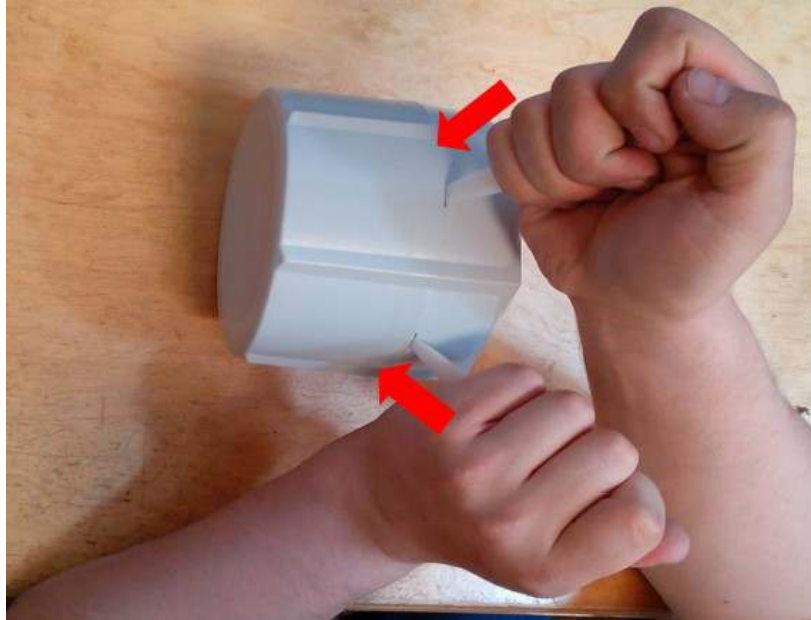

#### 2. step

Rotate screwdriver and pull both case parts.





3. step

Remove rubber bushing

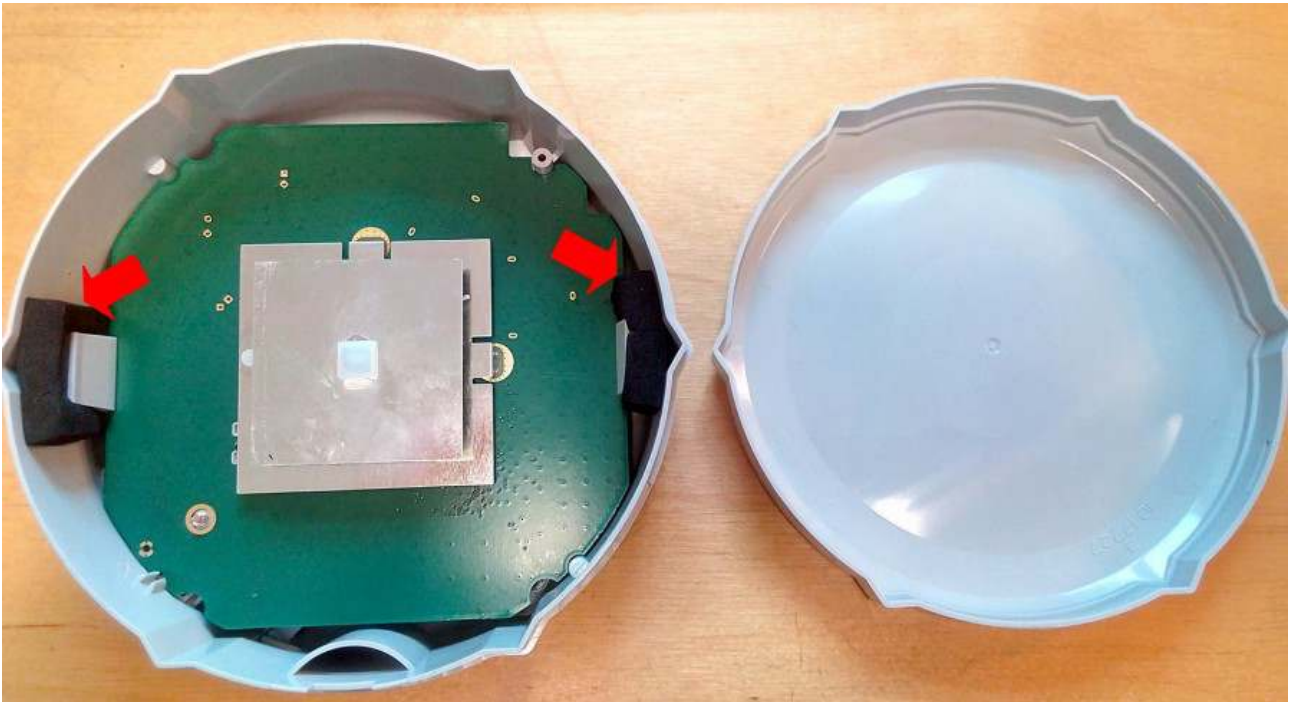

4. step

Push back Plastic PCB holders and take out the board.

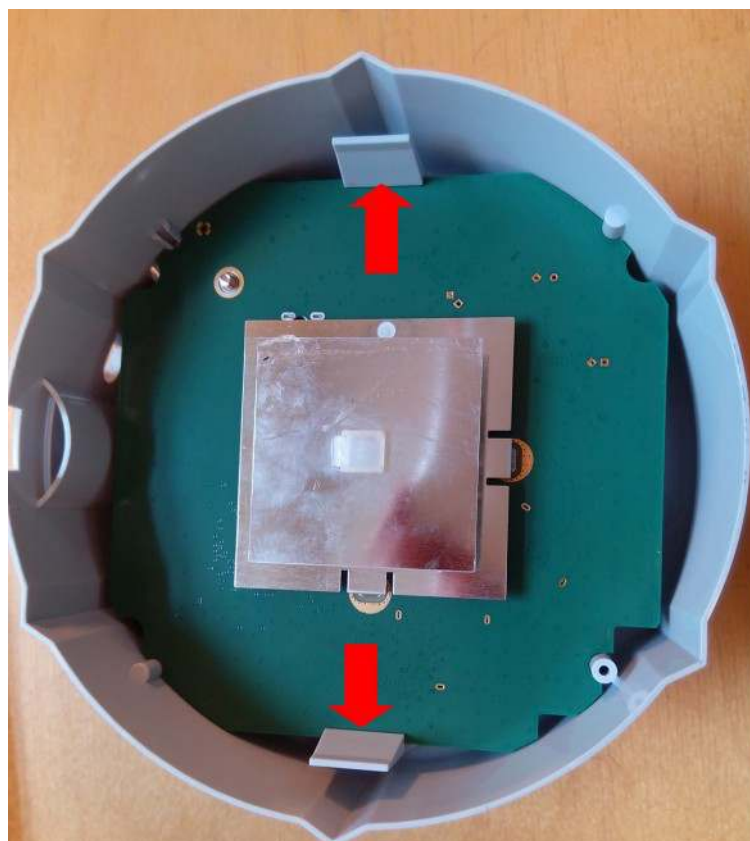

## Schottky diode measuring with multimeter in diode mode

Schottky diode reference numbers are D5 . Voltage drop value should be about 0,190V

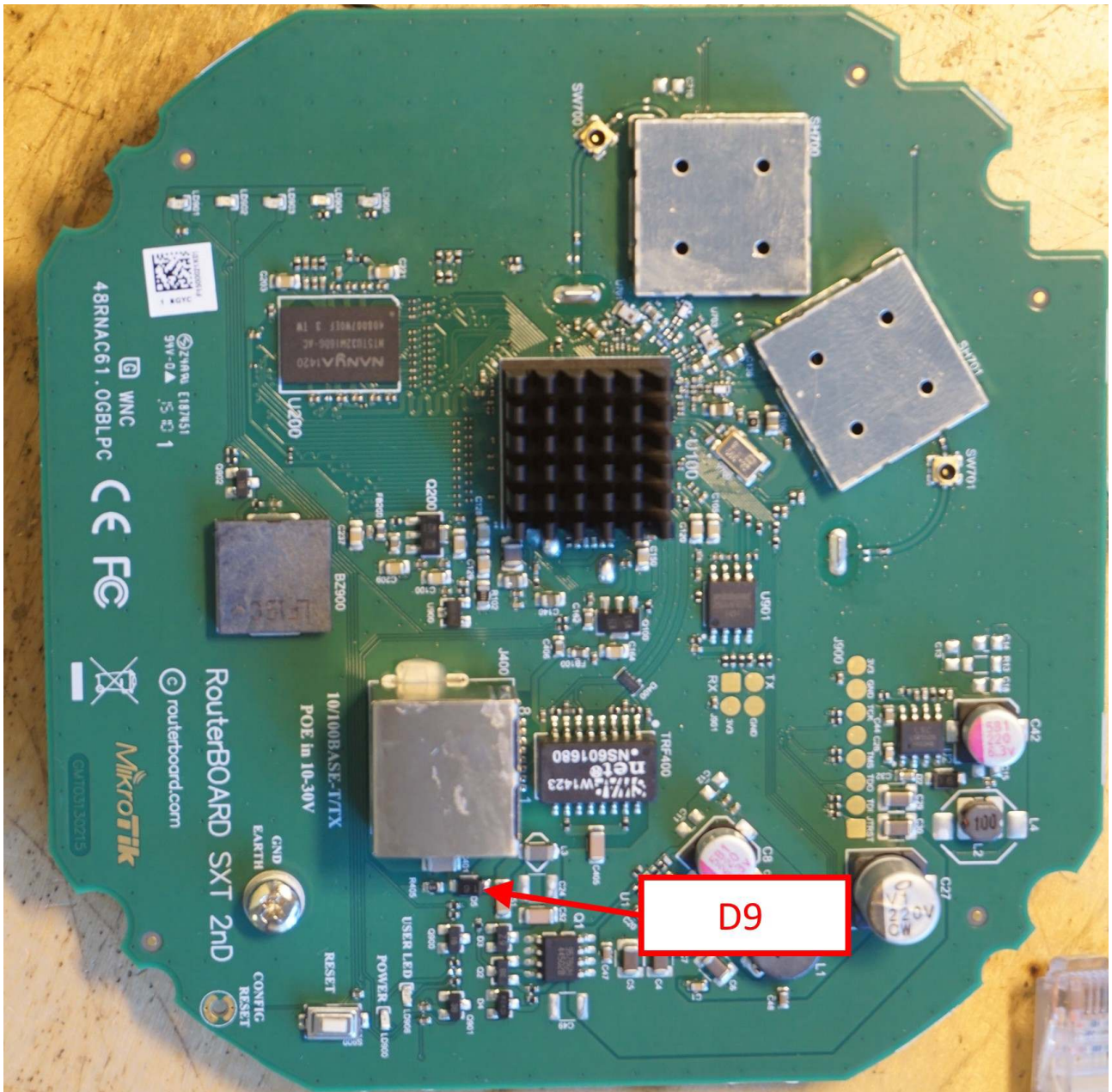

## Voltage drop between diode array pin#1 and Ground.

Check voltage drop between TRF400 Ethernet Transformers pins and Ground. Ether Pins are marked with red arrows.

It should be in the range from 0,32V to 0,48V

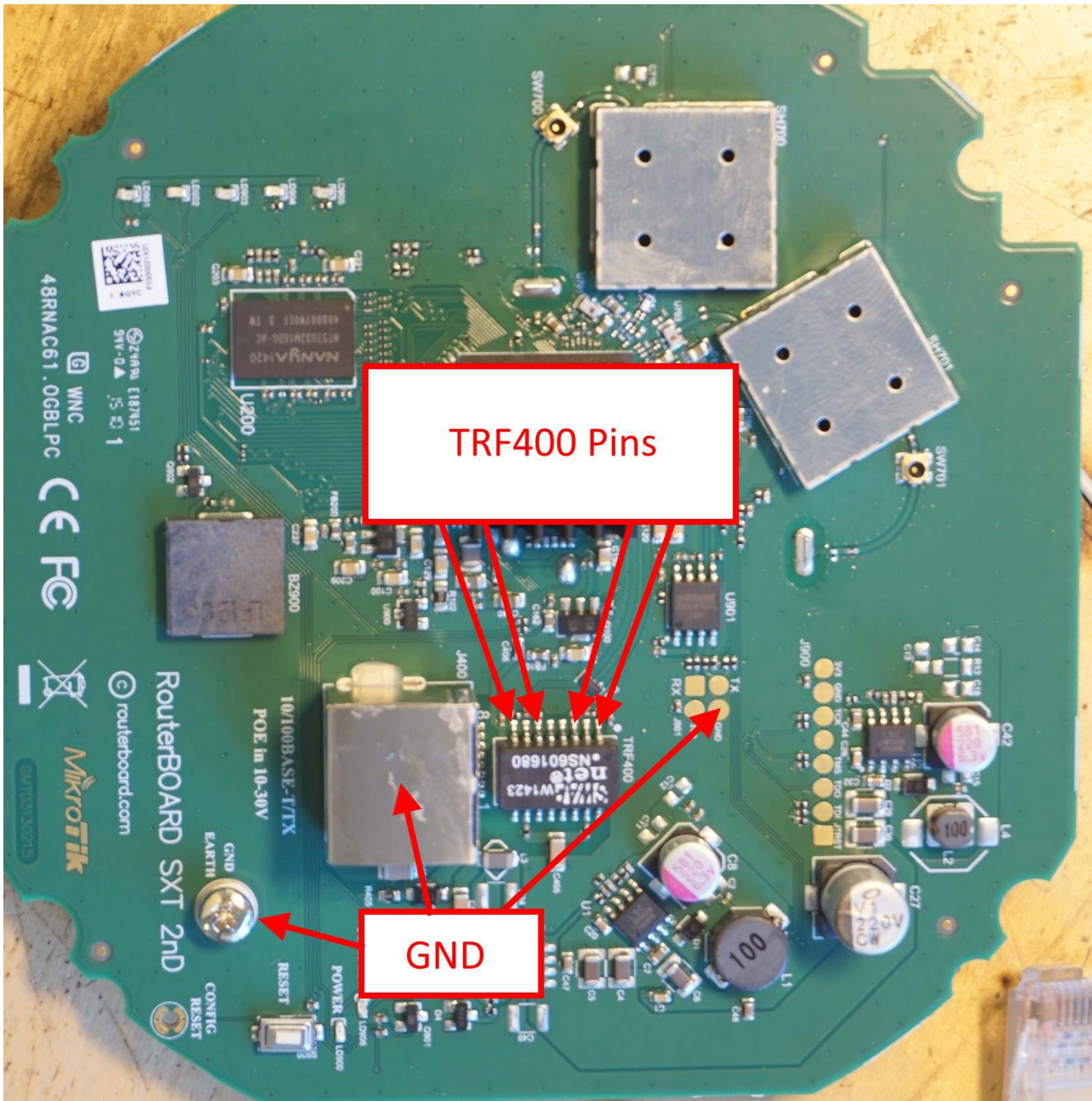

## 75R Termination resistors resistance.

Resistor resistance, marked with red arrow, should be 75 Ohm +/- 1%

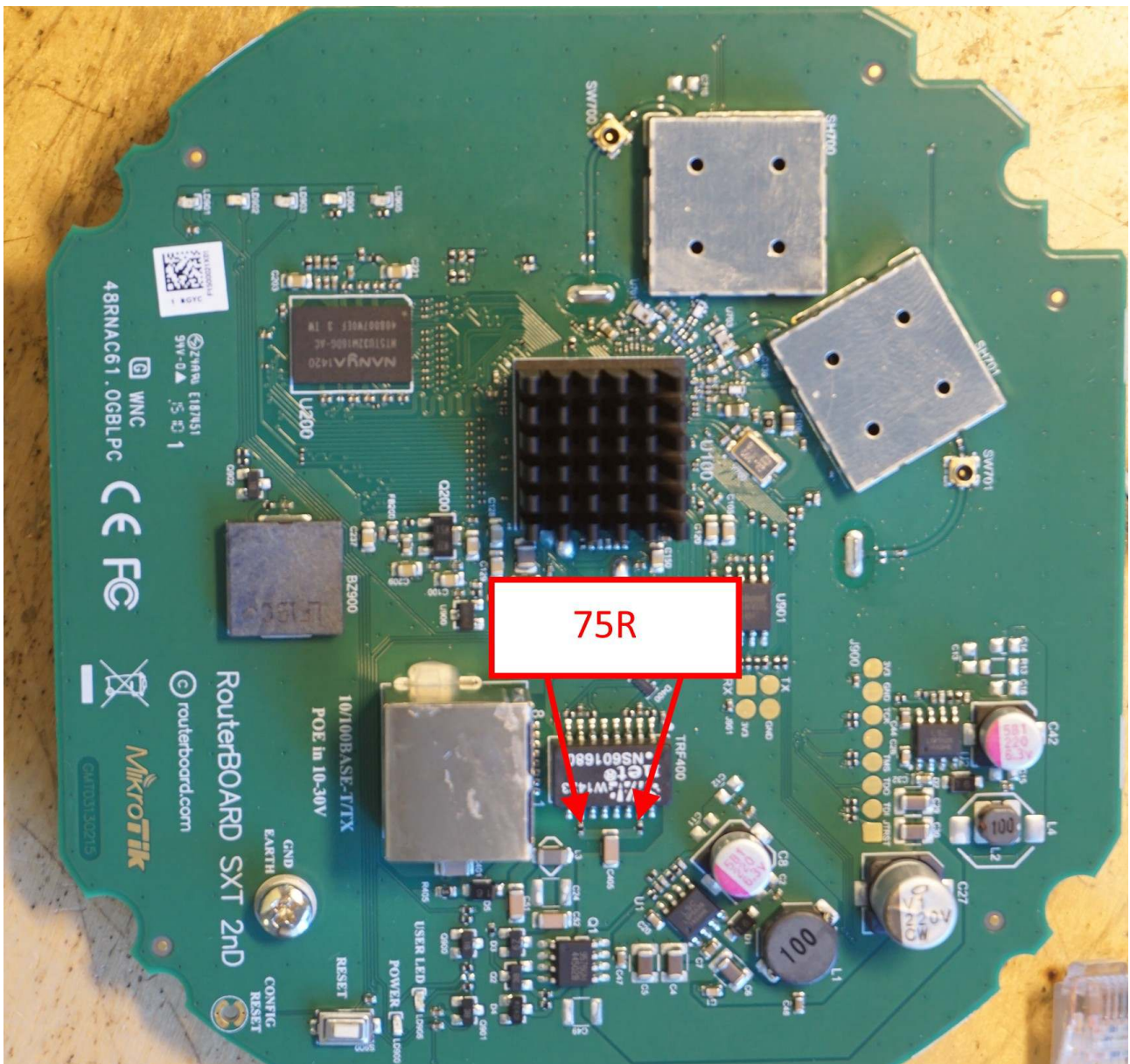

## RBSXTLite5 series RouterBoards

---

RBSXTLite5 series:

SXT Lite5



## Disassembling information

### SXT series disassembling

#### 1. step

Use two “-” screwdrivers. Push screwdrivers in case cavities.

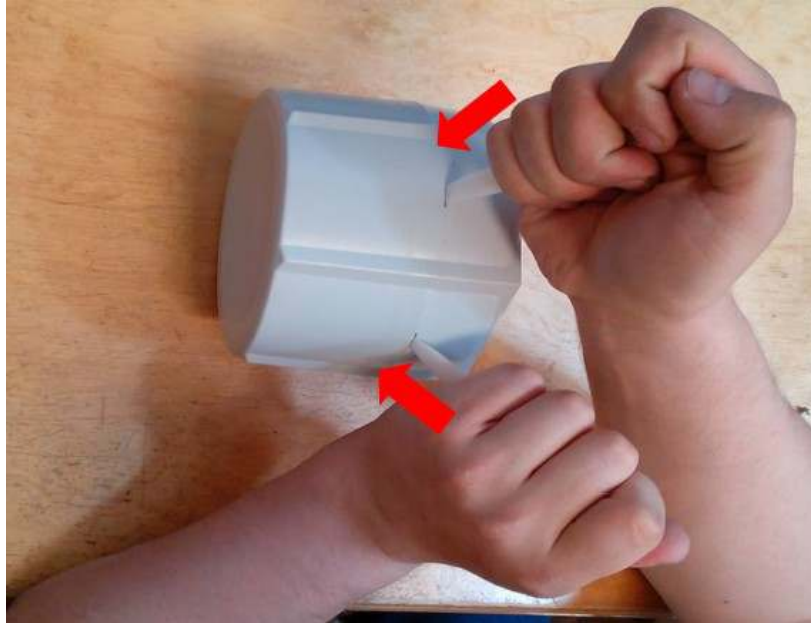

#### 2. step

Rotate screwdriver and pull both case parts.



3. step

Remove rubber bushing

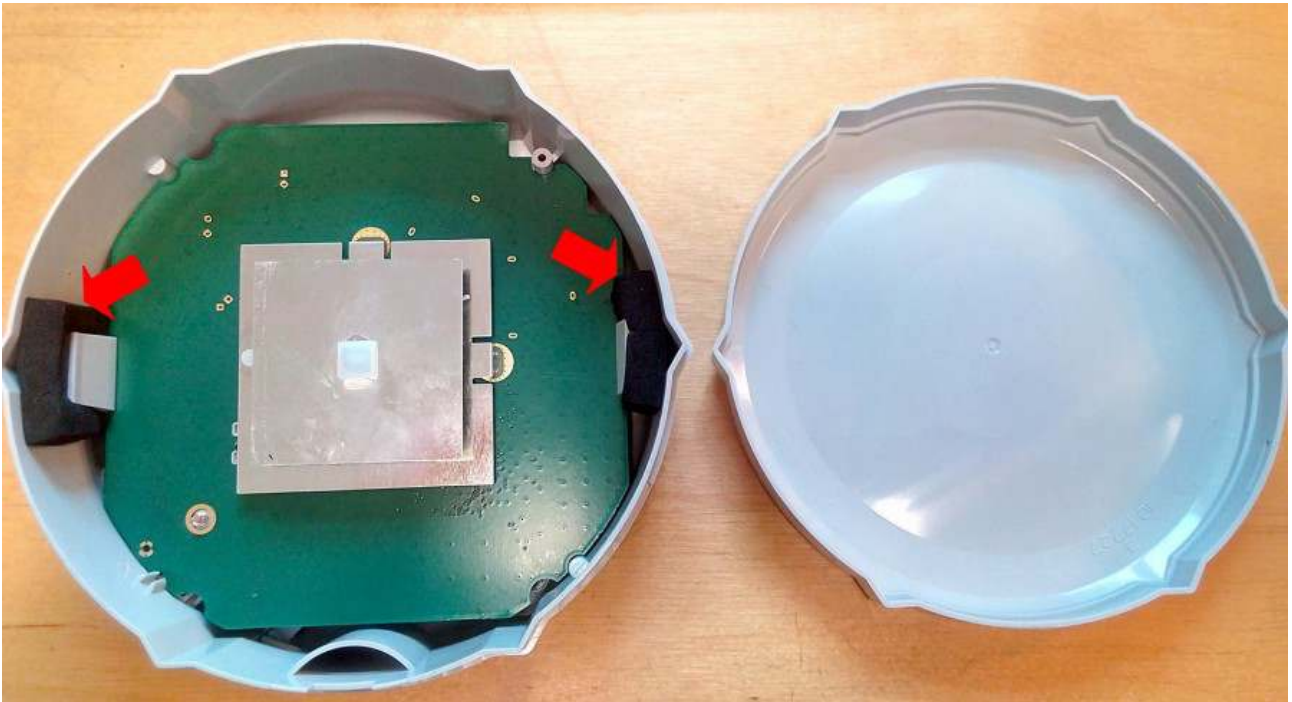

4. step

Push back Plastic PCB holders and take out the board.

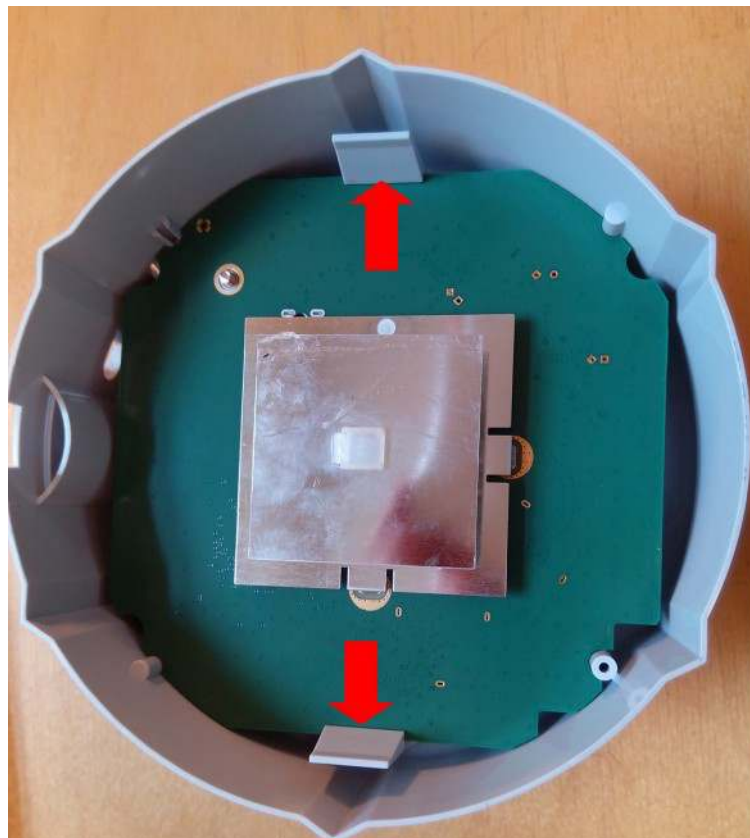





## Voltage drop between diode array pin#1 and Ground.

Check voltage drop between TRF400 Ethernet Transformers pins and Ground. Ether Pins are marked with red arrows.

It should be in the range from 0,32V to 0,48V

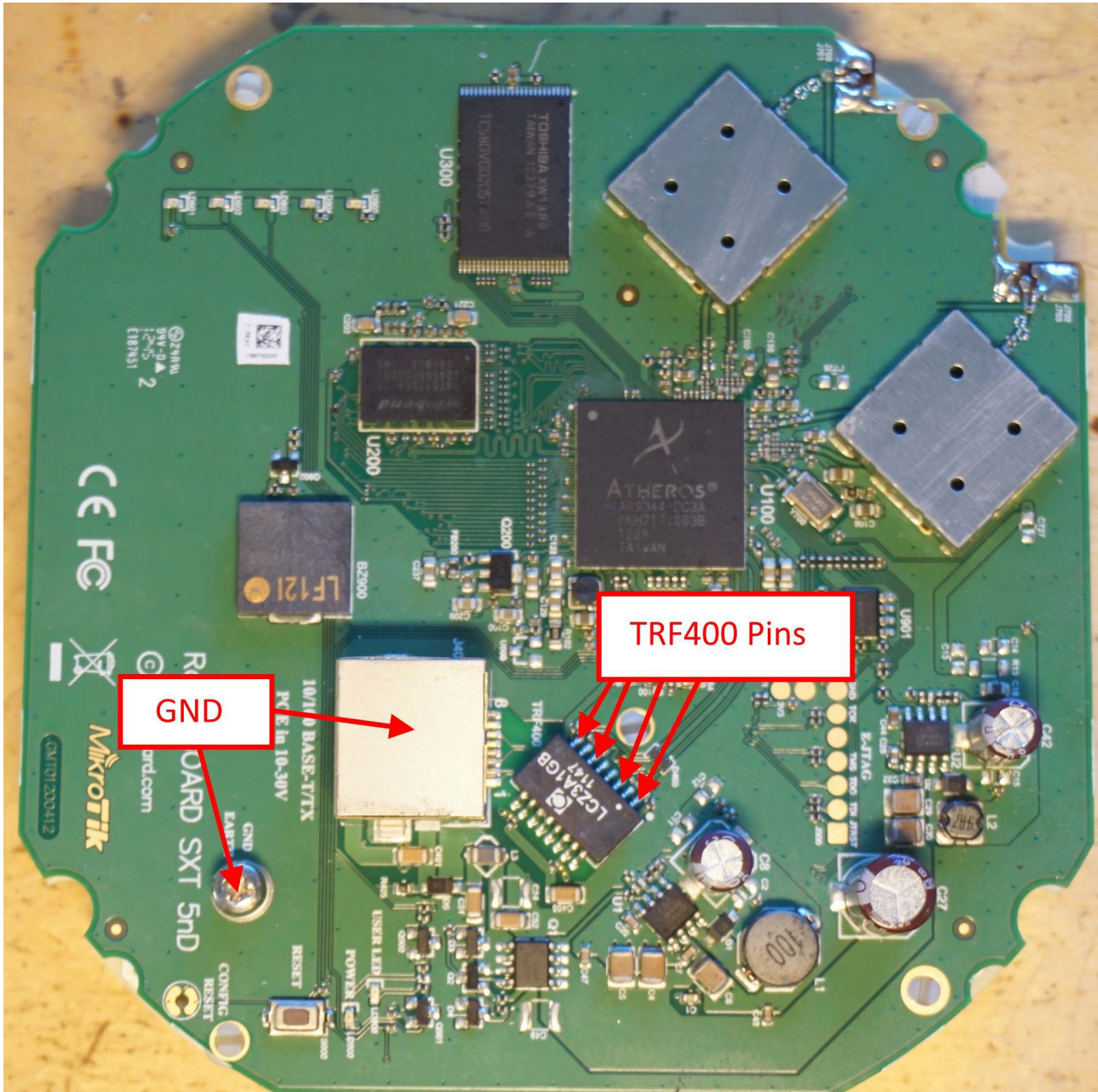

## 75R Termination resistors resistance.

Resistor resistance, marked with red arrow, should be 75 Ohm +/- 1%

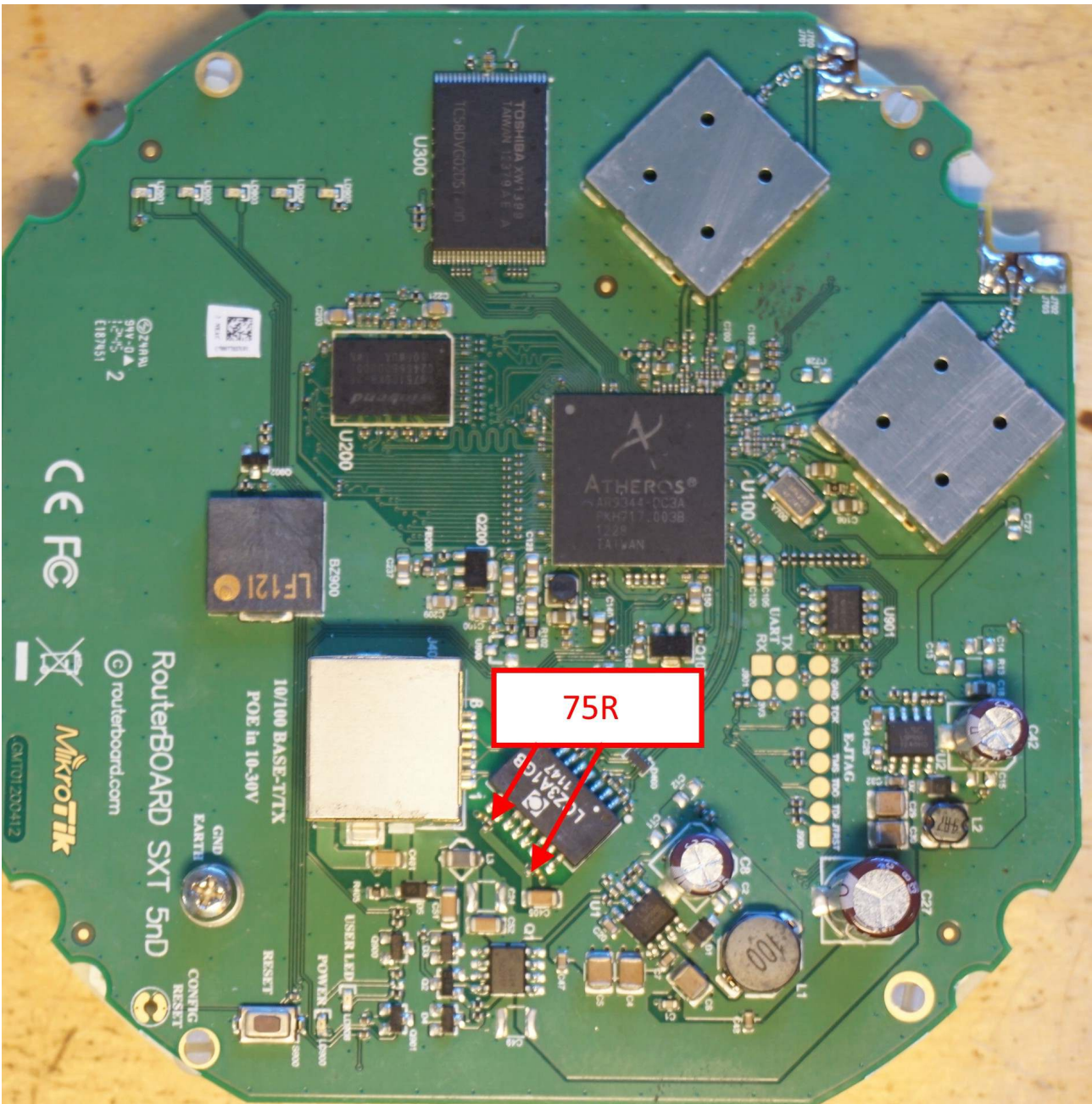

## RBSXTG-5HPnD series RouterBoards

---

RBSXTG-5HPnD series:

SXT HG5



SXT SA5



## Disassembling information

### SXT series disassembling

#### 1. step

Use two “-” screwdrivers. Push screwdrivers in case cavities.

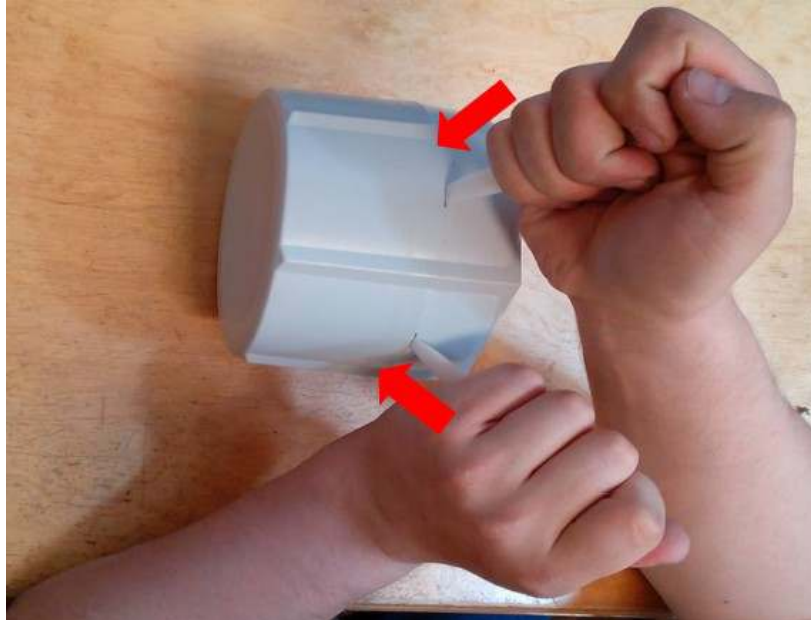

#### 2. step

Rotate screwdriver and pull both case parts.



3. step

Remove rubber bushing

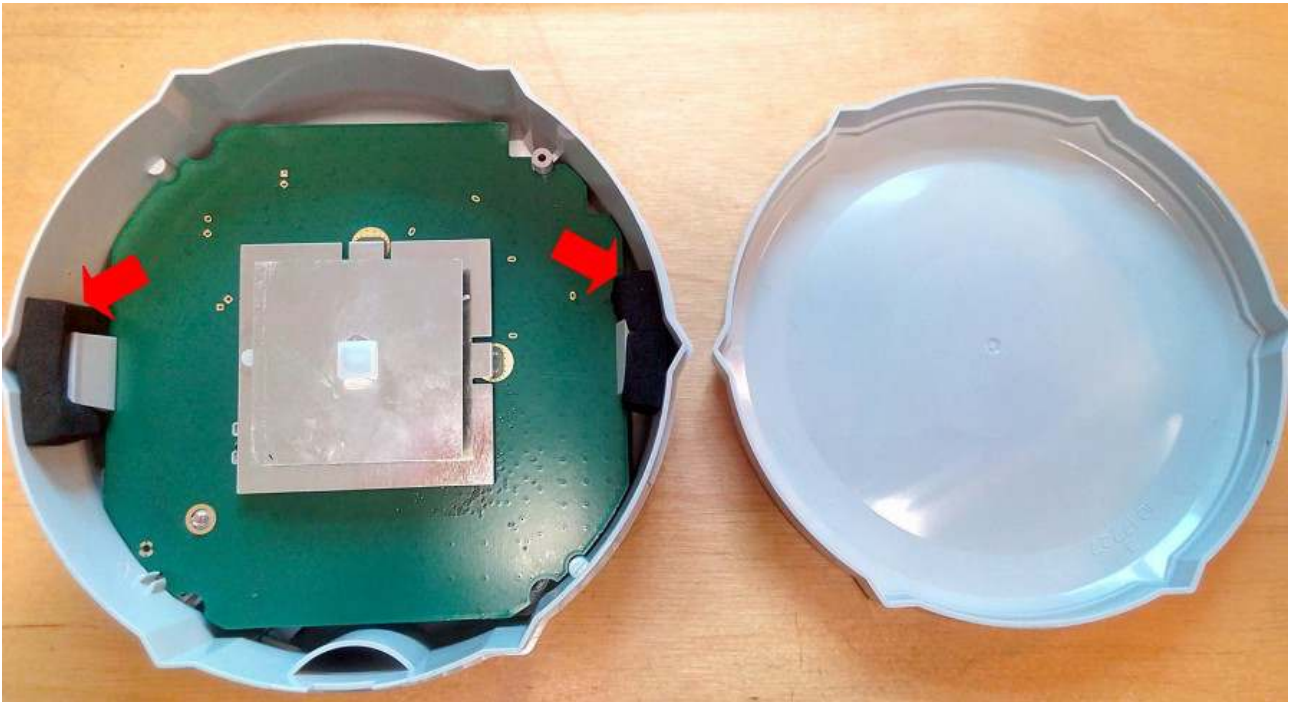

4. step

Push back Plastic PCB holders and take out the board.

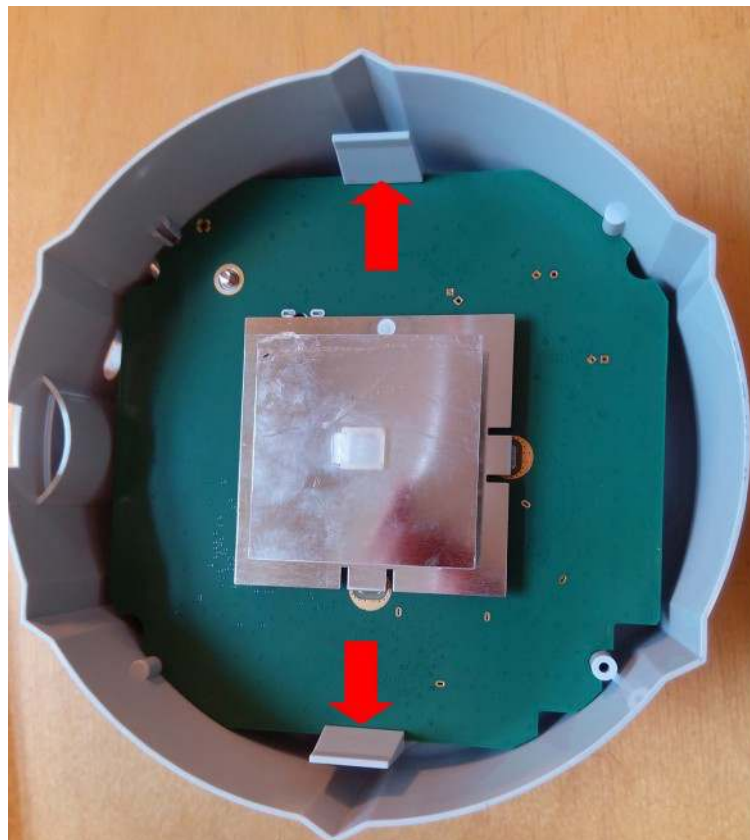

## Schottky diode measuring with multimeter in diode mode

Schottky diode reference numbers are D404, D405 . Voltage drop value should be about 0,247V

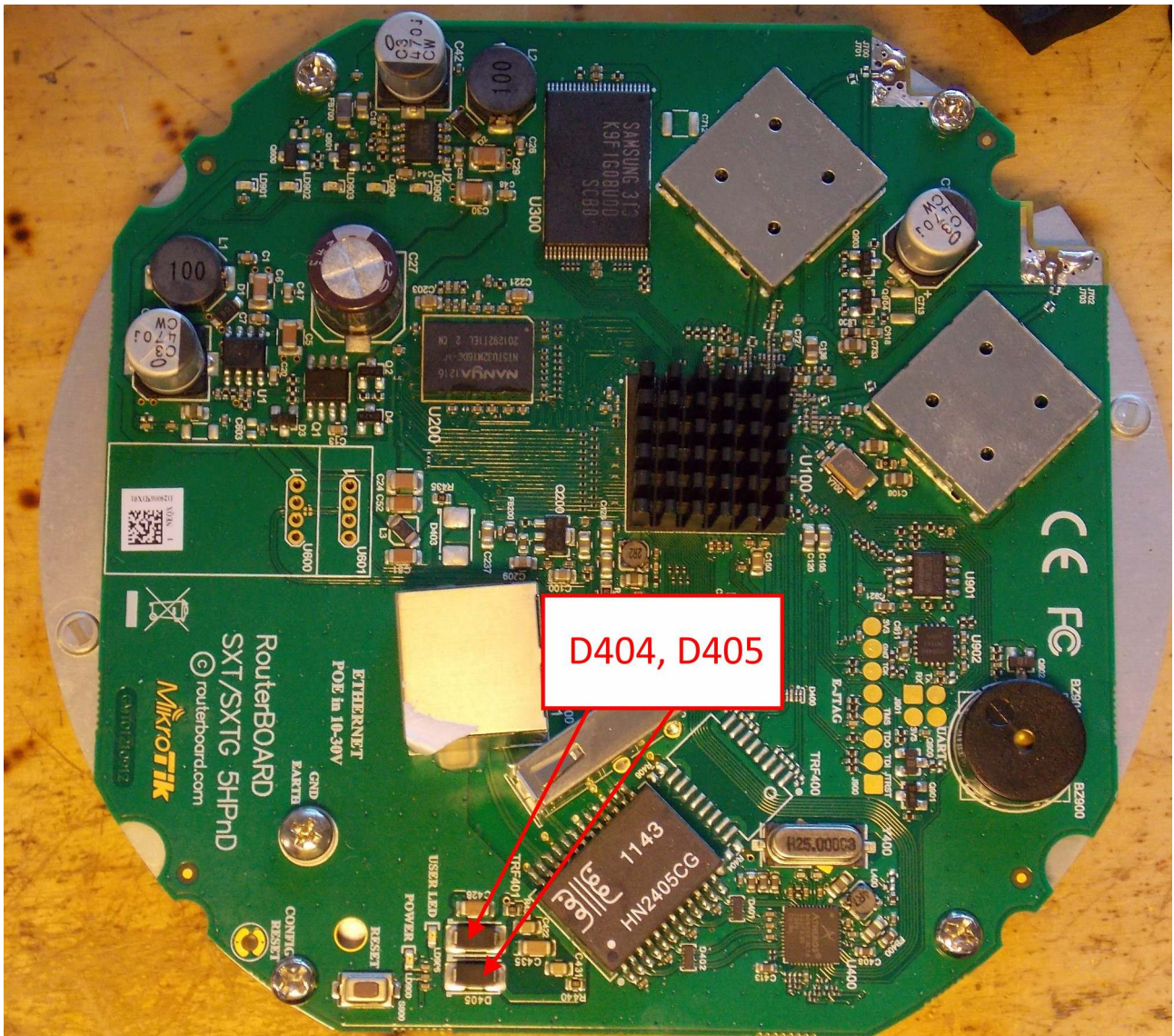

## Voltage drop between diode array pin#1 and Ground.

Check voltage drop between TRF401 Ethernet Transformers pins and Ground. Ether Pins are marked with red arrows.

It should be in the range from 0,32V to 0,48V

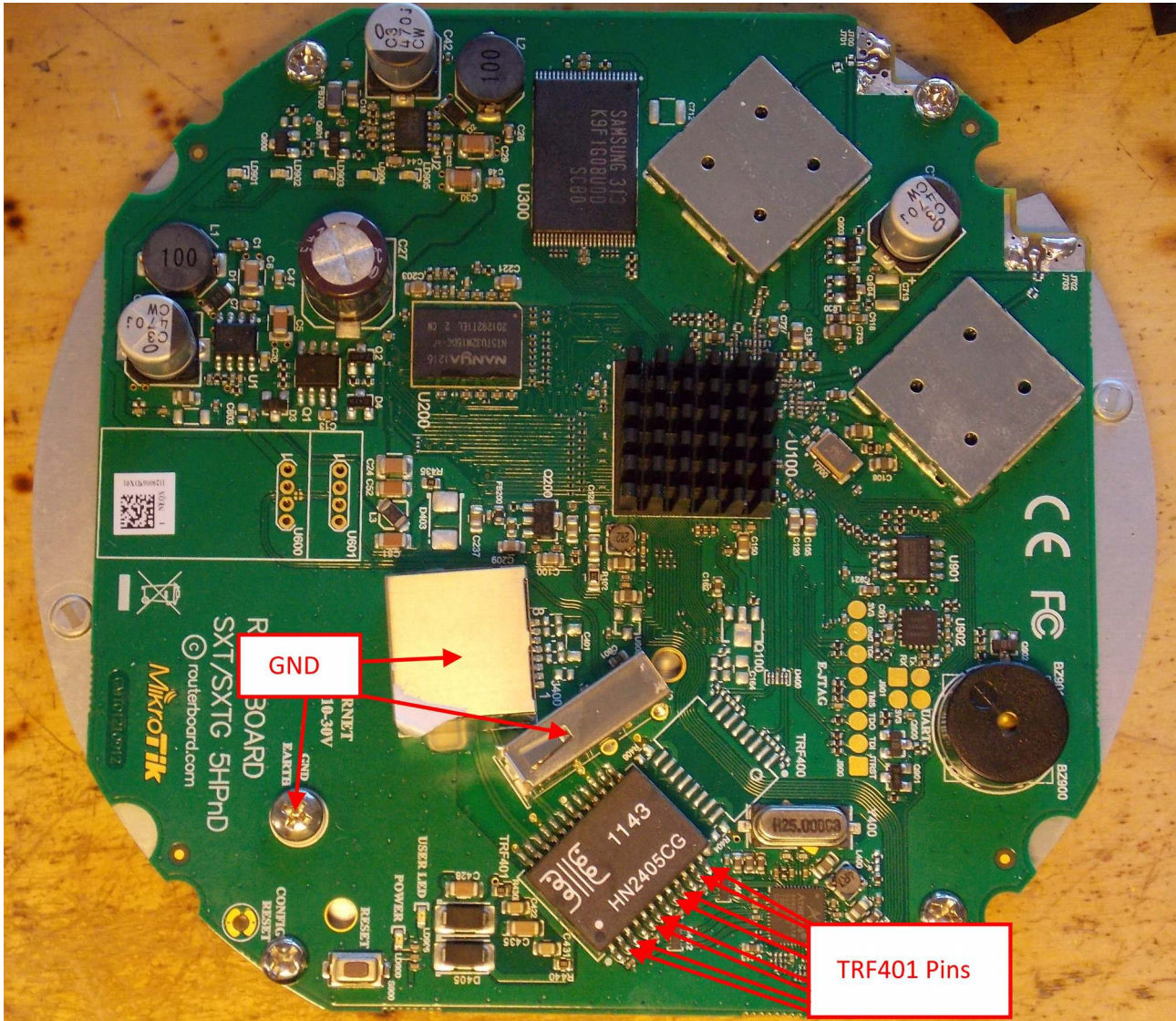

## 75R Termination resistors resistance.

Resistor resistance, marked with red arrow, should be 75 Ohm +/- 1%

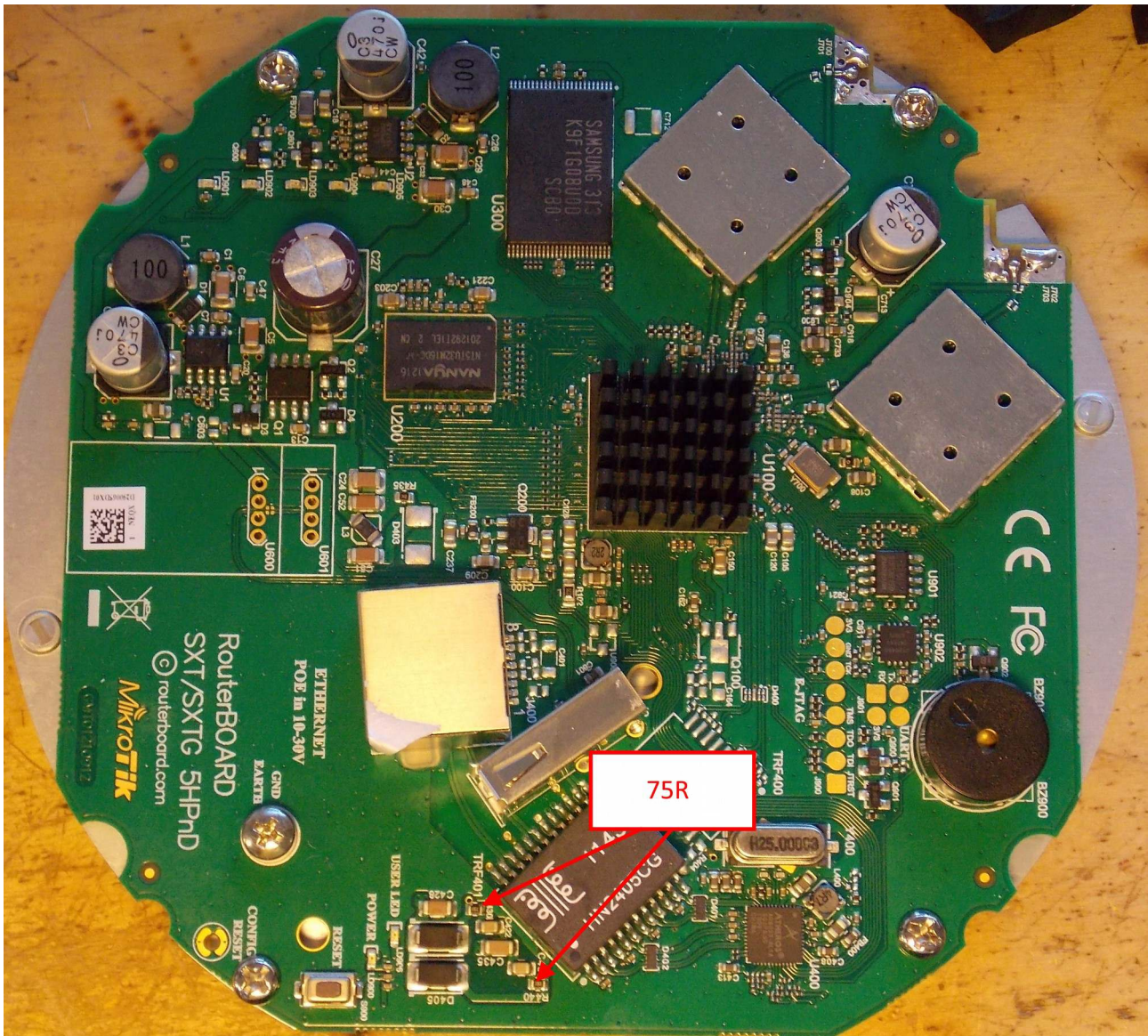



## hAP lite series RouterBoards

---

### hAP lite



## 1. Disassembling information

### hAP lite horizontal case disassembling

#### 1. step

Push “-” screwdrivers in case cavities.

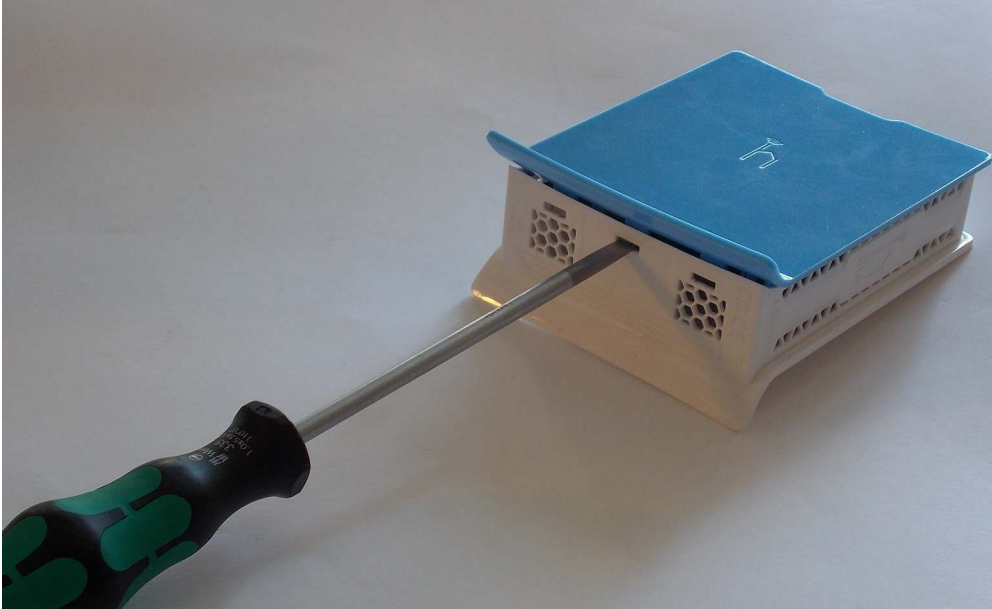

#### 2. step

Rotate screwdriver and pull both case parts.



3. step

Open front case and take out the board.

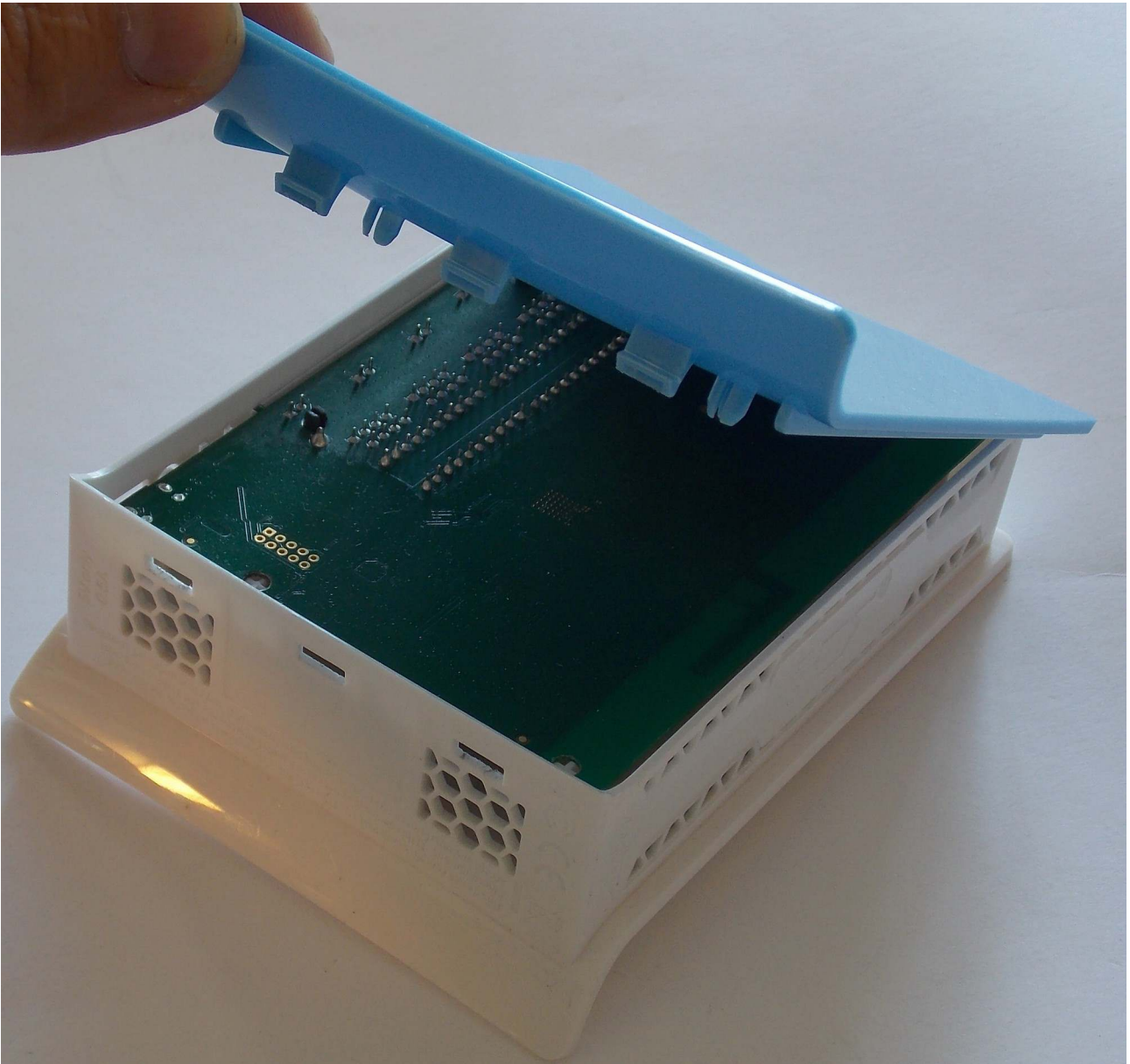

Horizontal case disassembling

Take off the cover with a screwdriver as shown in the picture1



Picture1

Take out the board with a screwdriver as shown in the picture2

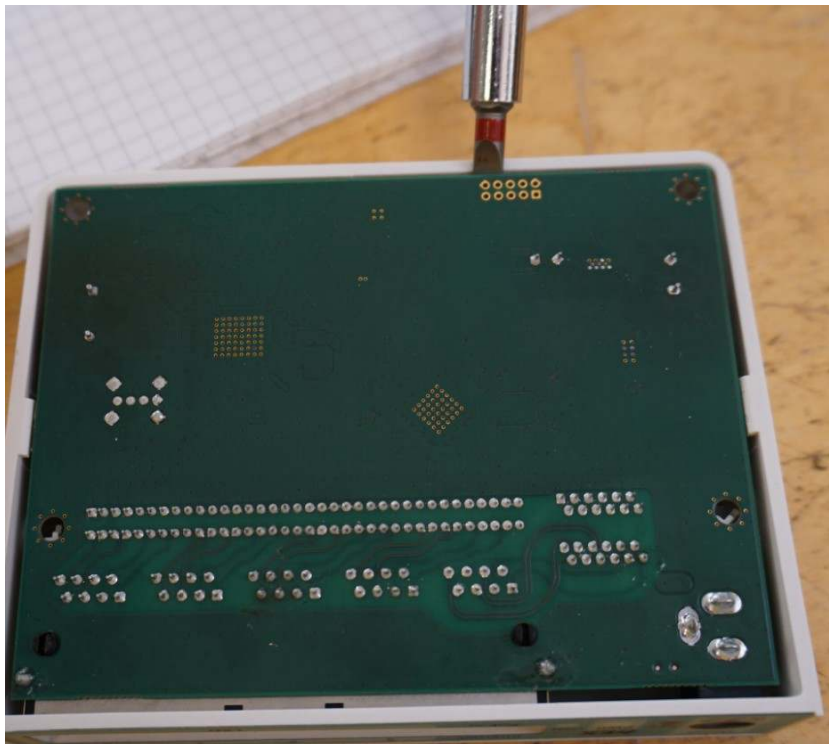

Picture1

## Voltage drop between Ethernet signal lines and Ground.

Check voltage drop between TR1 Ethernet Transformers pins and Ground. Ether Pins are marked with red arrows.

It should be in the range from 0,32V to 0,48V

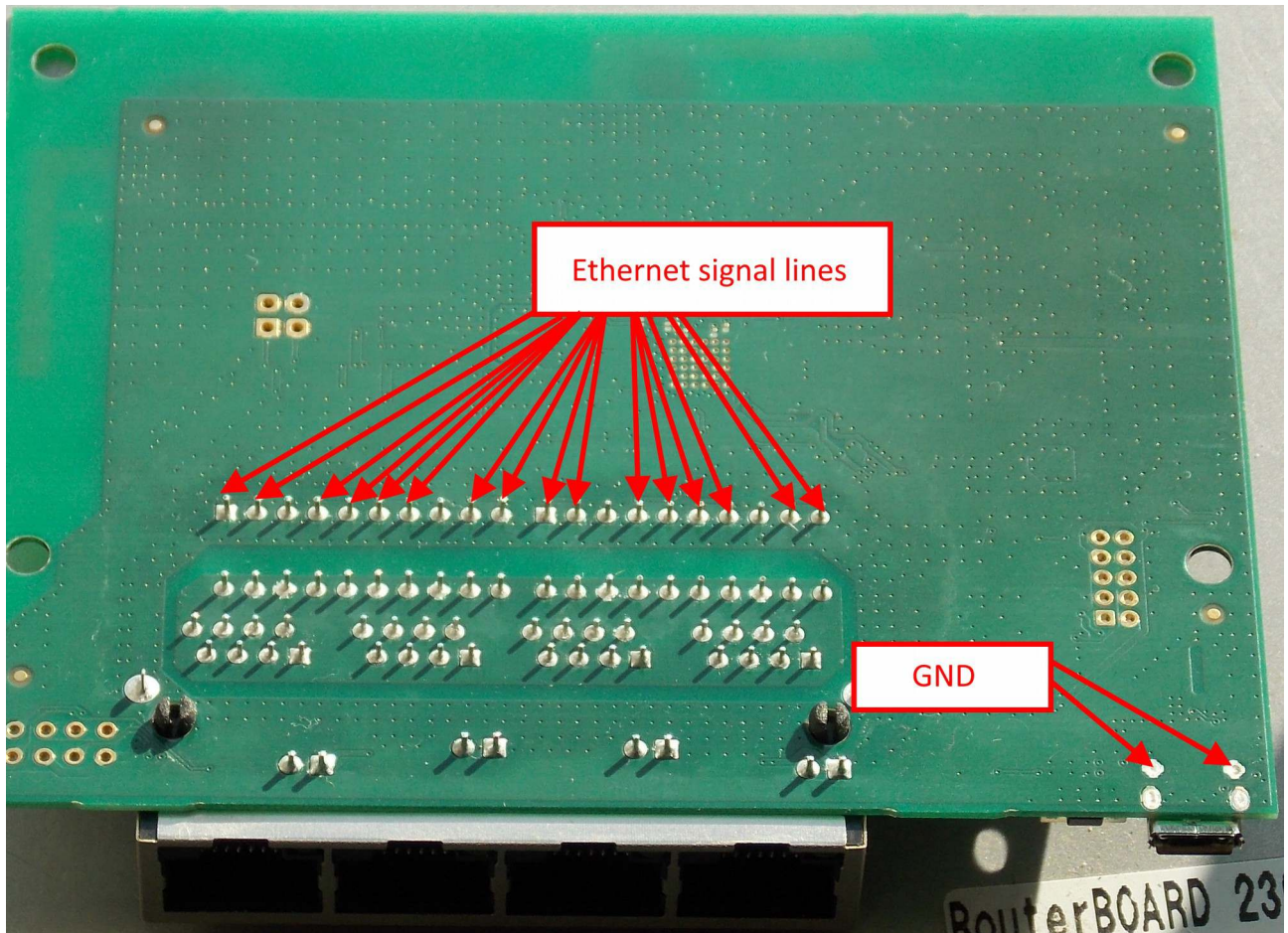

## RB951G-2HnD series RouterBoards

---

### RB951G-2HnD



## Disassembling information

### 951G-2HnD disassembling

Take off the cover with a screwdriver as shown in the pictures



Take out the board with a screwdriver as shown in the picture



## Schottky diode measuring with multimeter in diode mode

Diode bridge reference numbers are D4 and D6. Voltage drop value should be about 0,588V



## Voltage drop between diode array pin#1 and Ground.

Check voltage drop between TR100 Ethernet Transformers on ports Ether1 – Ether5 pins and Ground. Ether Pins are marked with red arrows.

It should be in the range from 0,32V to 0,438V

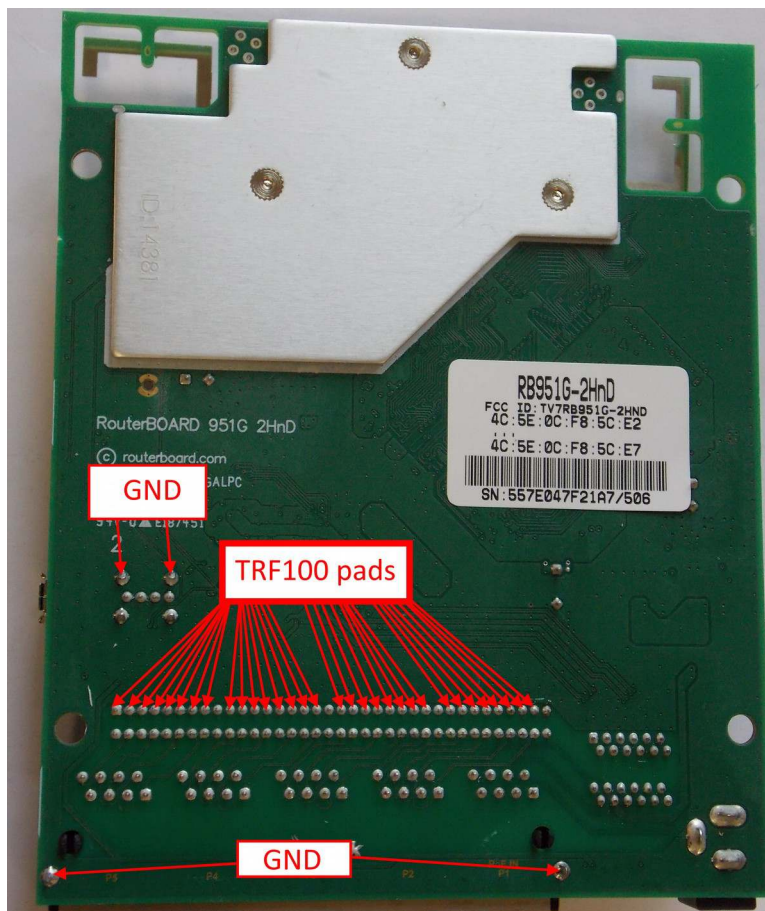



## 75R termination resistors resistance

Red circled resistors resistance should be 75R +/- 1%

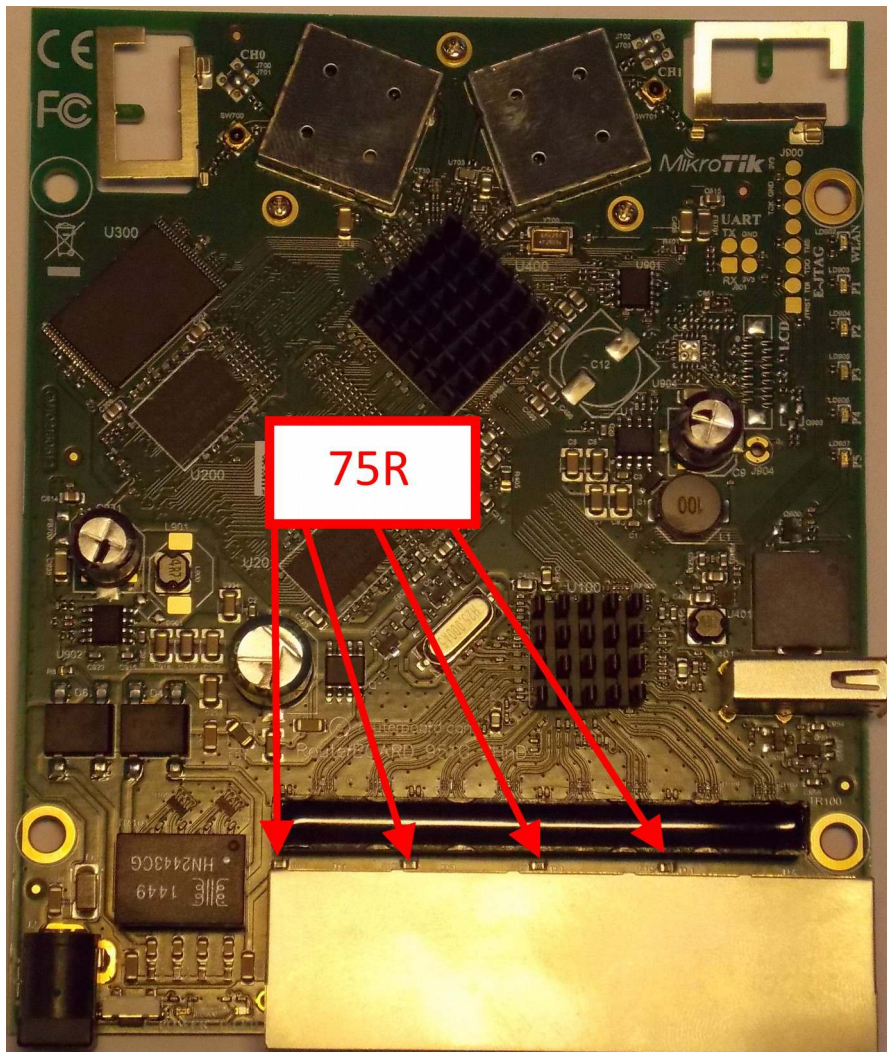

## RB951Ui-2HnD series RouterBoards

---

### RB951Ui-2HnD



## Disassembling information

Take off the cover with a screwdriver as shown in the pictures



Take out the board with a screwdriver as shown in the picture



## Schottky diode measuring with multimeter in diode mode

Diode bridge reference numbers are D2, D4 and D1000. Voltage drop value should be about 0,236V

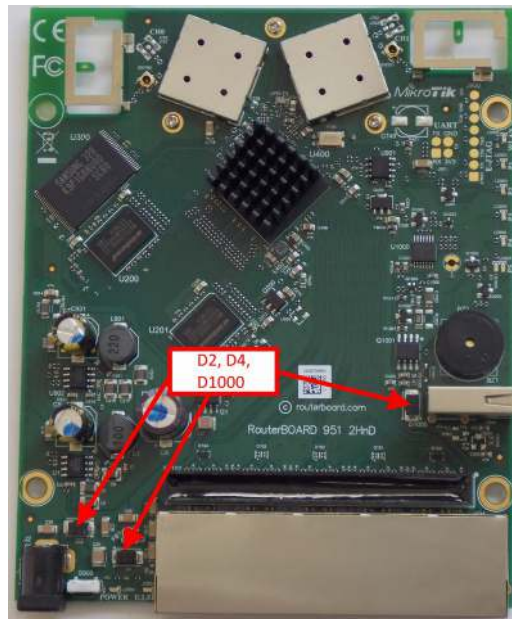

## Voltage drop between diode array pin#1 and Ground.

Check voltage drop between TR100 Ethernet Transformers on ports Ether1 – Ether5 pins and Ground. Ether Pins are marked with red arrows.

It should be in the range from 0,32V to 0,438V

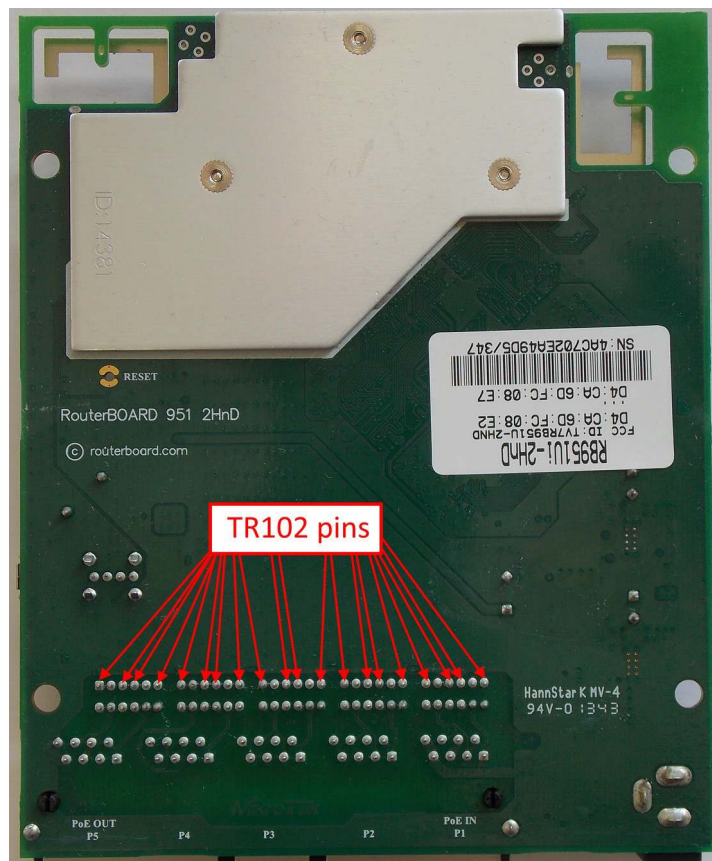

## 75R termination resistors resistance

Red circled resistors resistance should be 75R +/- 1%

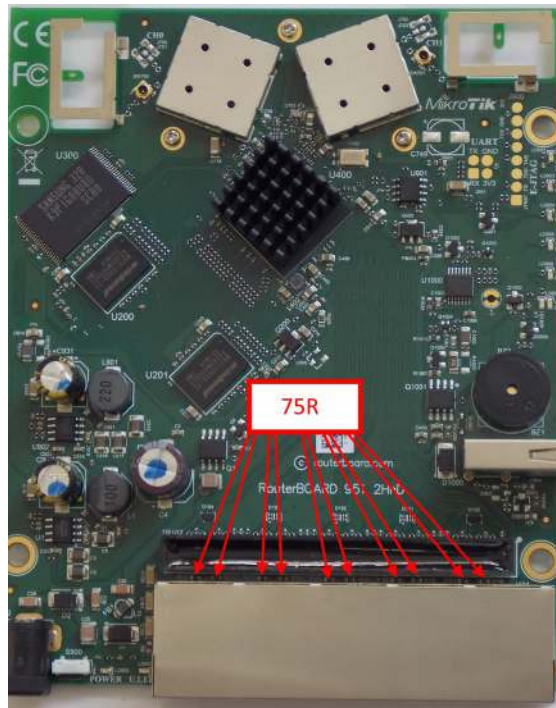

## RB751U-2HnD series RouterBoards

---

### RB751U-2HnD



## Disassembling information

Take off the cover with a screwdriver as shown in the pictures



Take out the board with a screwdriver as shown in the picture



## Schottky diode measuring with multimeter in diode mode

Diode bridge reference numbers are D2 and D4. Voltage drop value should be about 0,222V

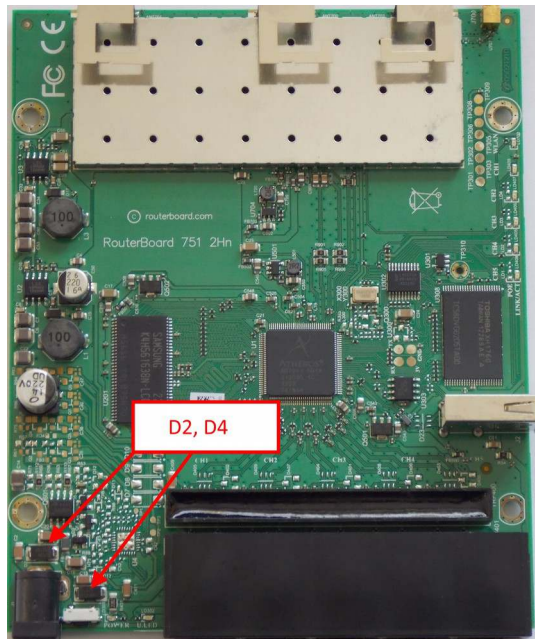

## Voltage drop between diode array pin#1 and Ground.

Check voltage drop between TR100 Ethernet Transformers on ports Ether1 – Ether5 pins and Ground. Ether Pins are marked with red arrows.

It should be in the range from 0,32V to 0,438V

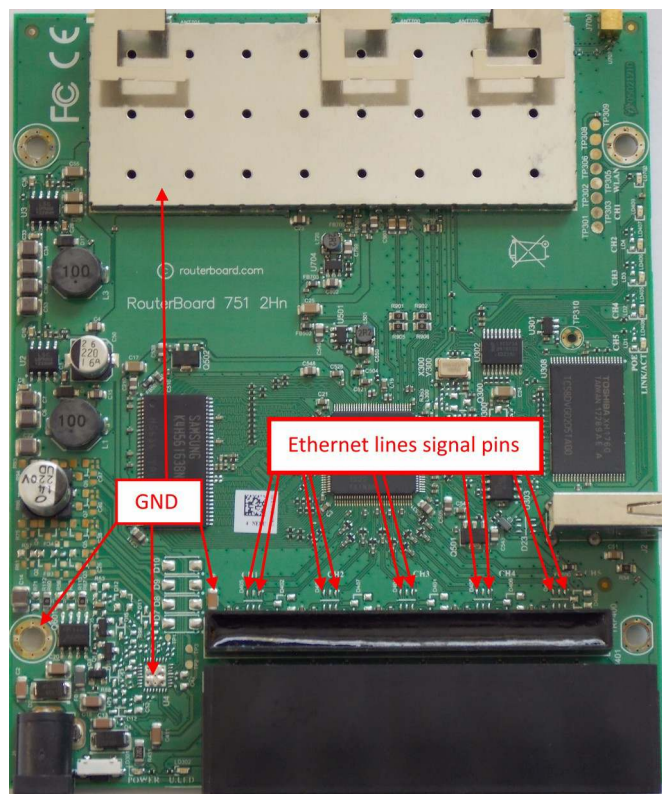



## 75R termination resistors resistance

Red circled resistors resistance should be 75R +/- 1%

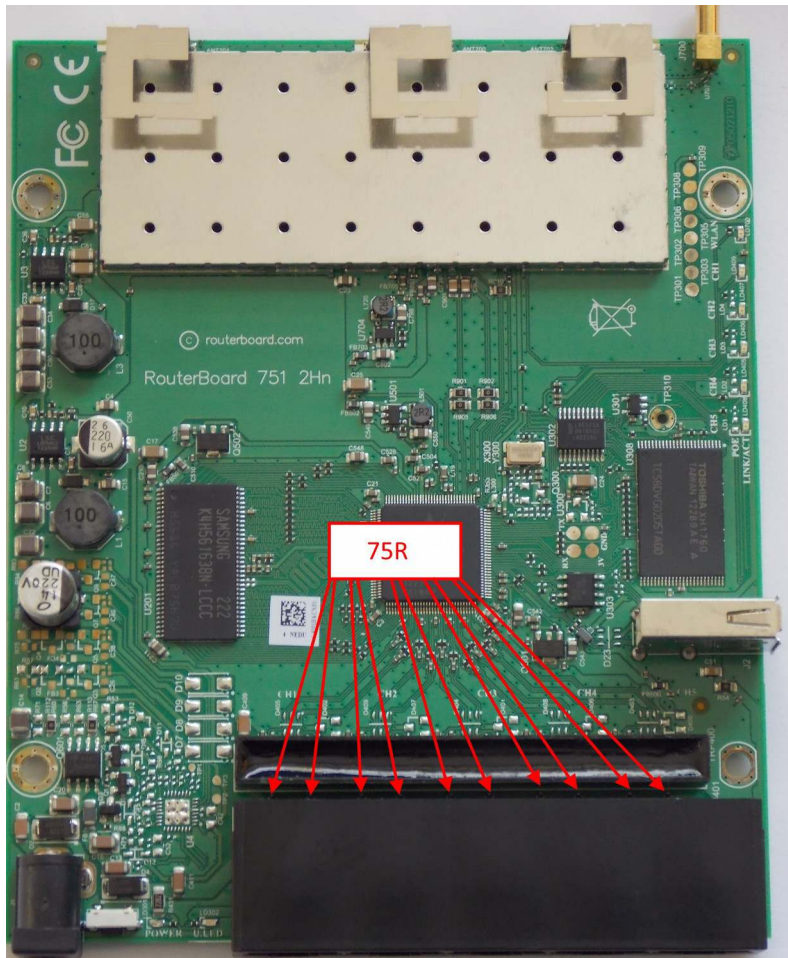

## RB951-2n series RouterBoards

---

### RB951-2n



## Disassembling information

Take off the cover with a screwdriver as shown in the picture1

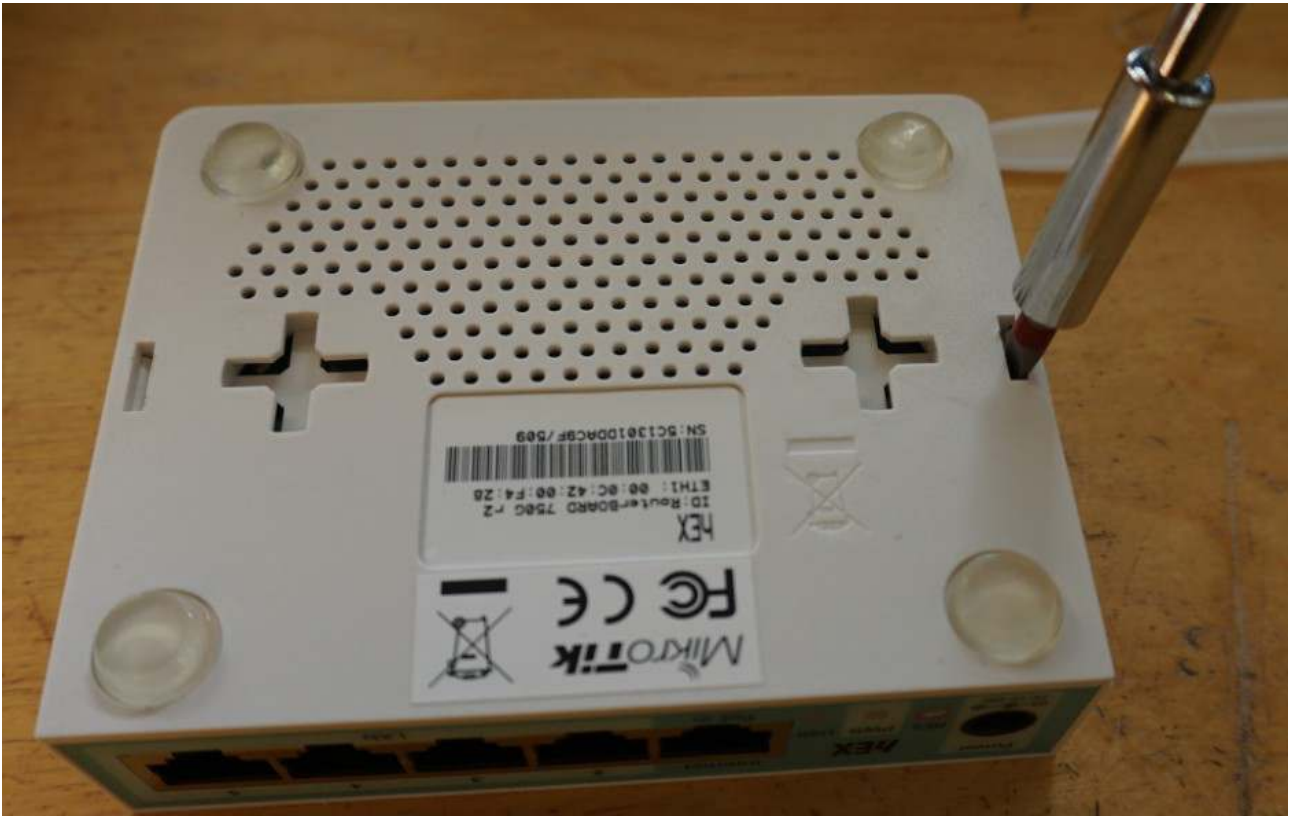

Picture1

Take out the board with a screwdriver as shown in the picture2

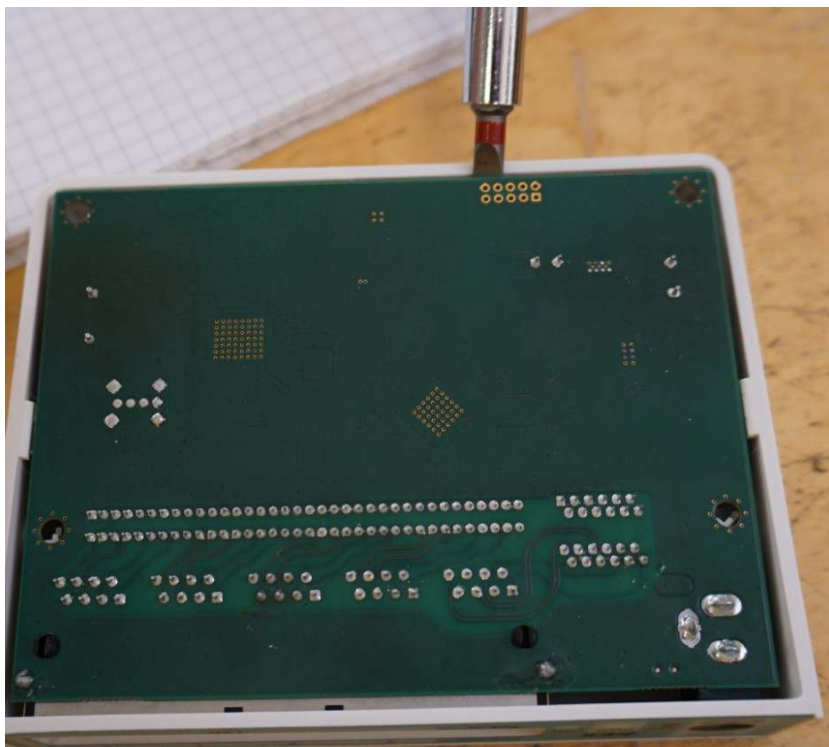

Picture1

## Schottky diode measuring with multimeter in diode mode

Schottky diode reference numbers are D400, D402. Voltage drop value should be about 0,215V

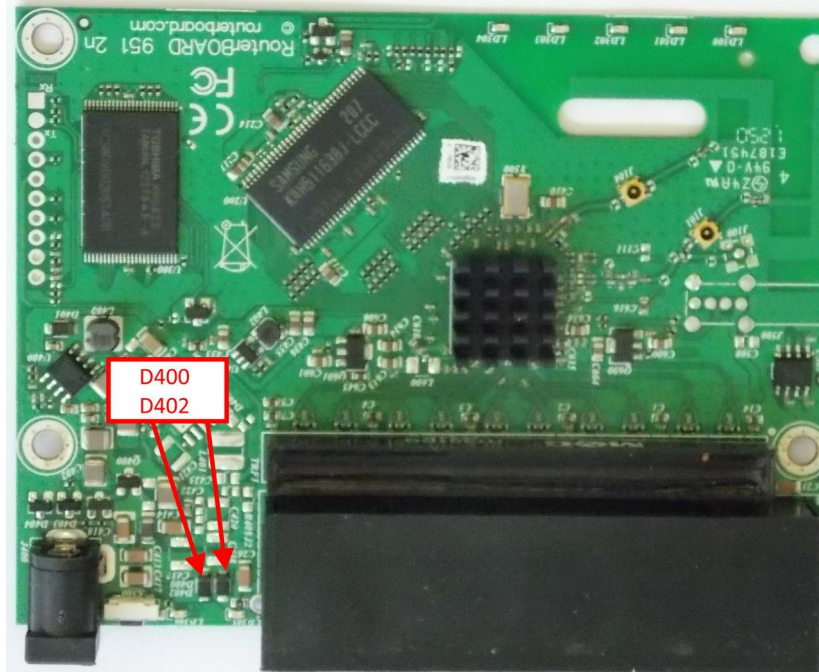

## Voltage drop between diode array pin#1 and Ground.

Check voltage drop between TR1 Ethernet Transformers on ports Ether1 – Ether5 pins and Ground. Ether Pins are circled red.

It should be in the range from 0,32V to 0,438V

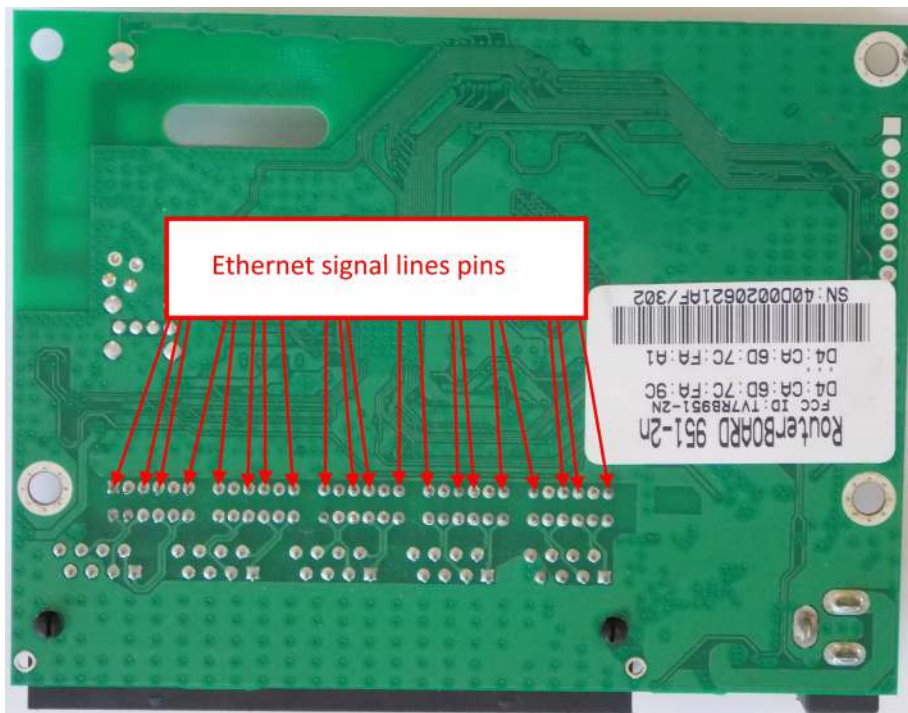

## 75R termination resistors resistance

Red circled resistors resistance should be 75Ohm +/- 1%

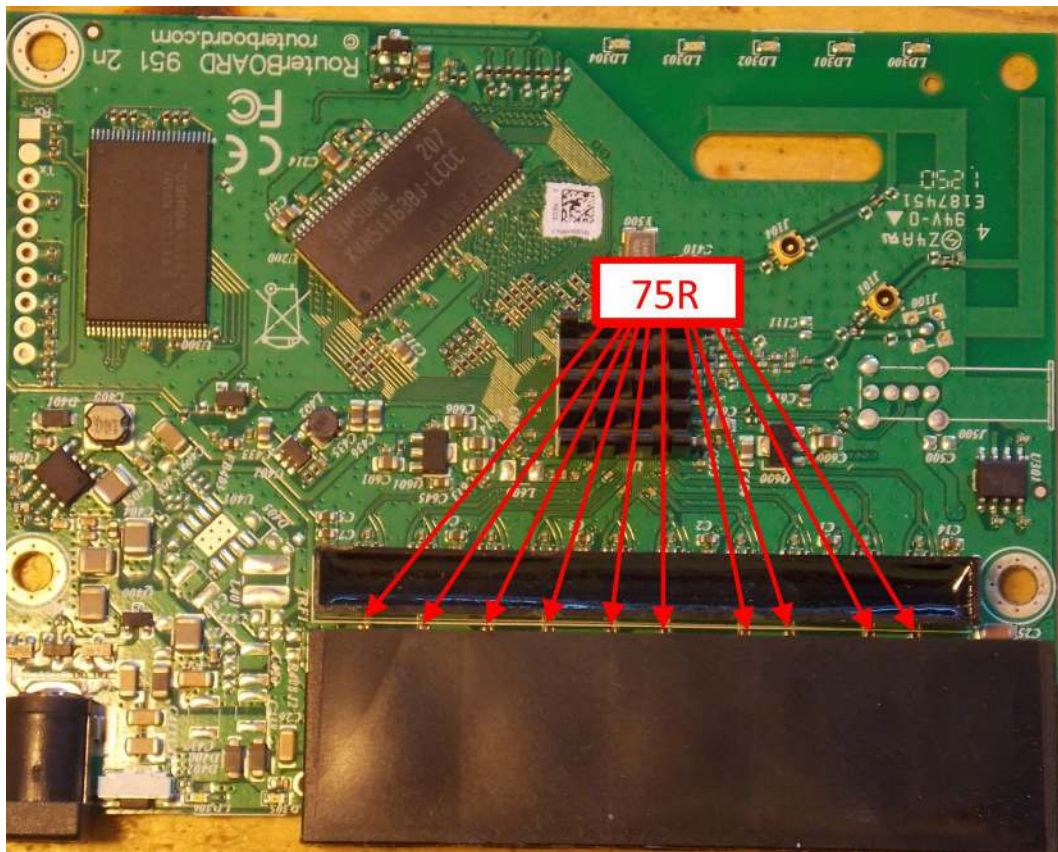

## CRS112-8G-4S series RouterBoards

---

### CRS112-8G-4S-IN

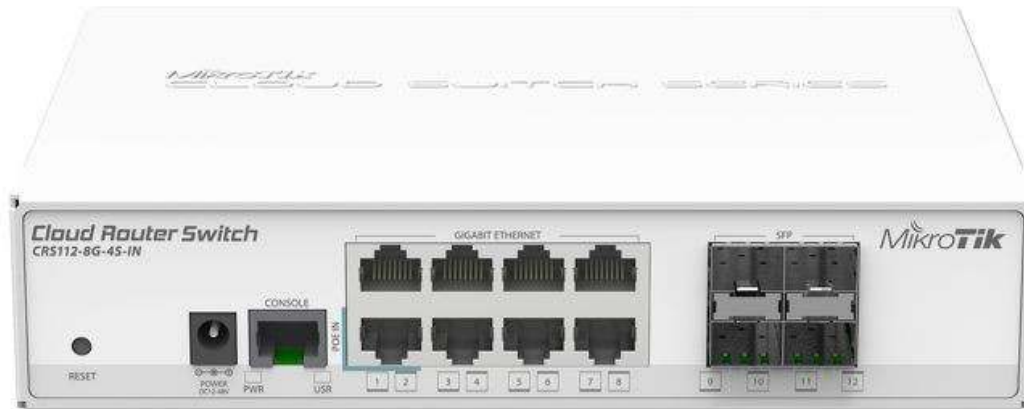

### Disassembling information

1. Step: use PH2 screw driver to loose backside screws, take off cover.

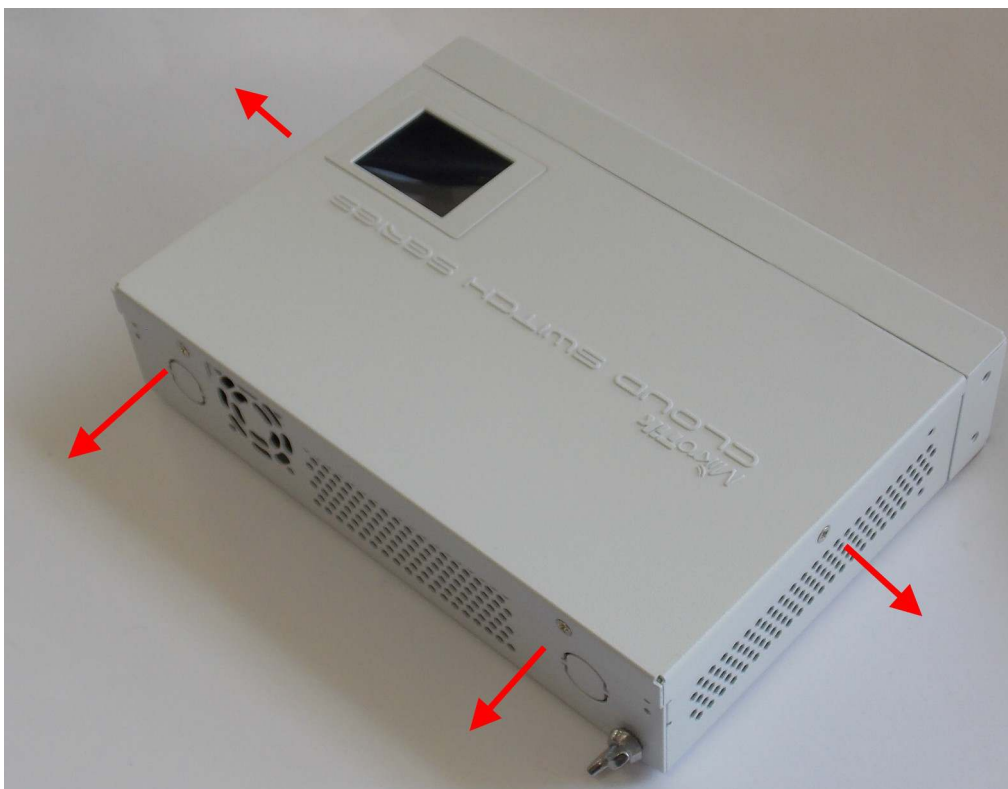

2. step: take off cover carefully, pay a tension to LCD connector. Push up both side of LCD connector from slot with “-” screwdriver as shown in next pictures

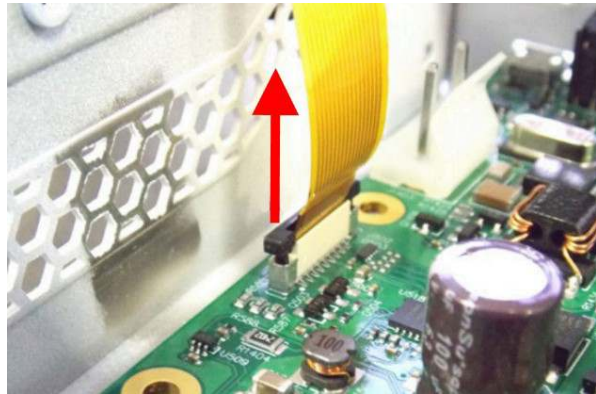

3. Step: use “+” screw driver to loose 7 pcs PCB screws, than take off PCB from case.

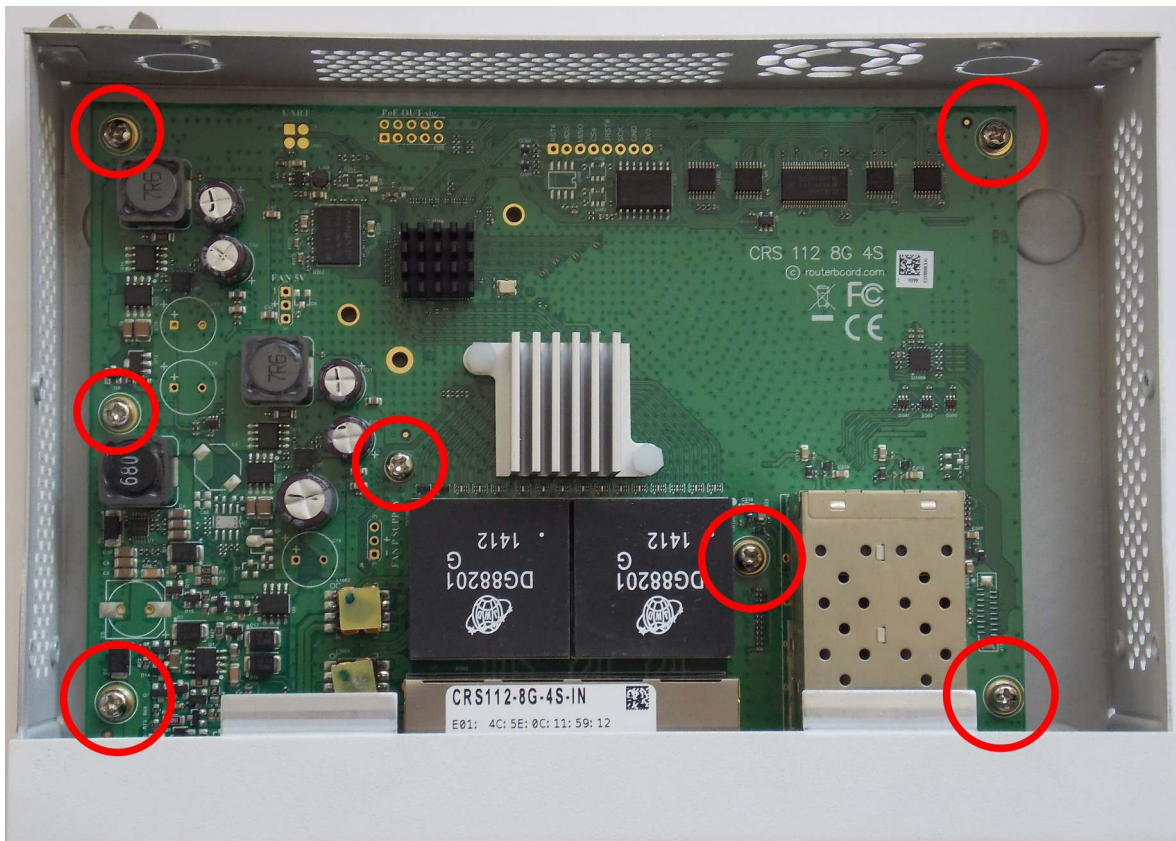

## Schottky diode measuring with multimeter in diode mode

Schottky diode reference numbers are D3, D5, D11, D16, D17. Voltage drop value should be about 0,215V

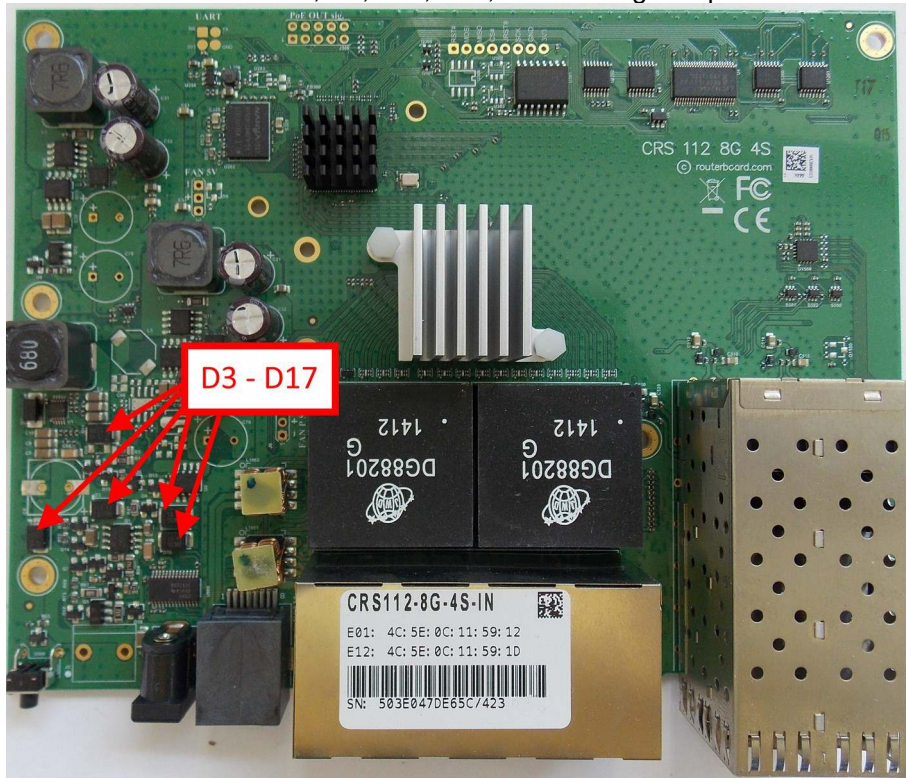

## Voltage drop between diode array pin#1 and Ground.

Check voltage drop between TR1200 and TR1201 Ethernet Transformers on ports Ether1 – Ether8 pins and Ground. Ether Pins are circled red. It should be in the range from 0,32V to 0,438V

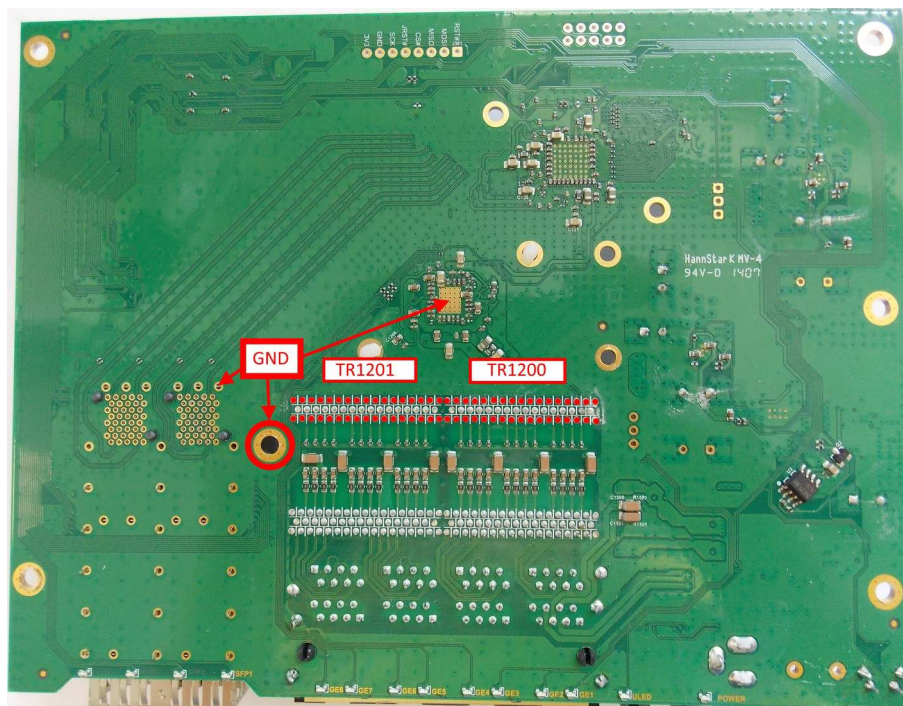



## 75R termination resistors resistance

Resistors marked with red arrows should be 75Ohm +/- 1%

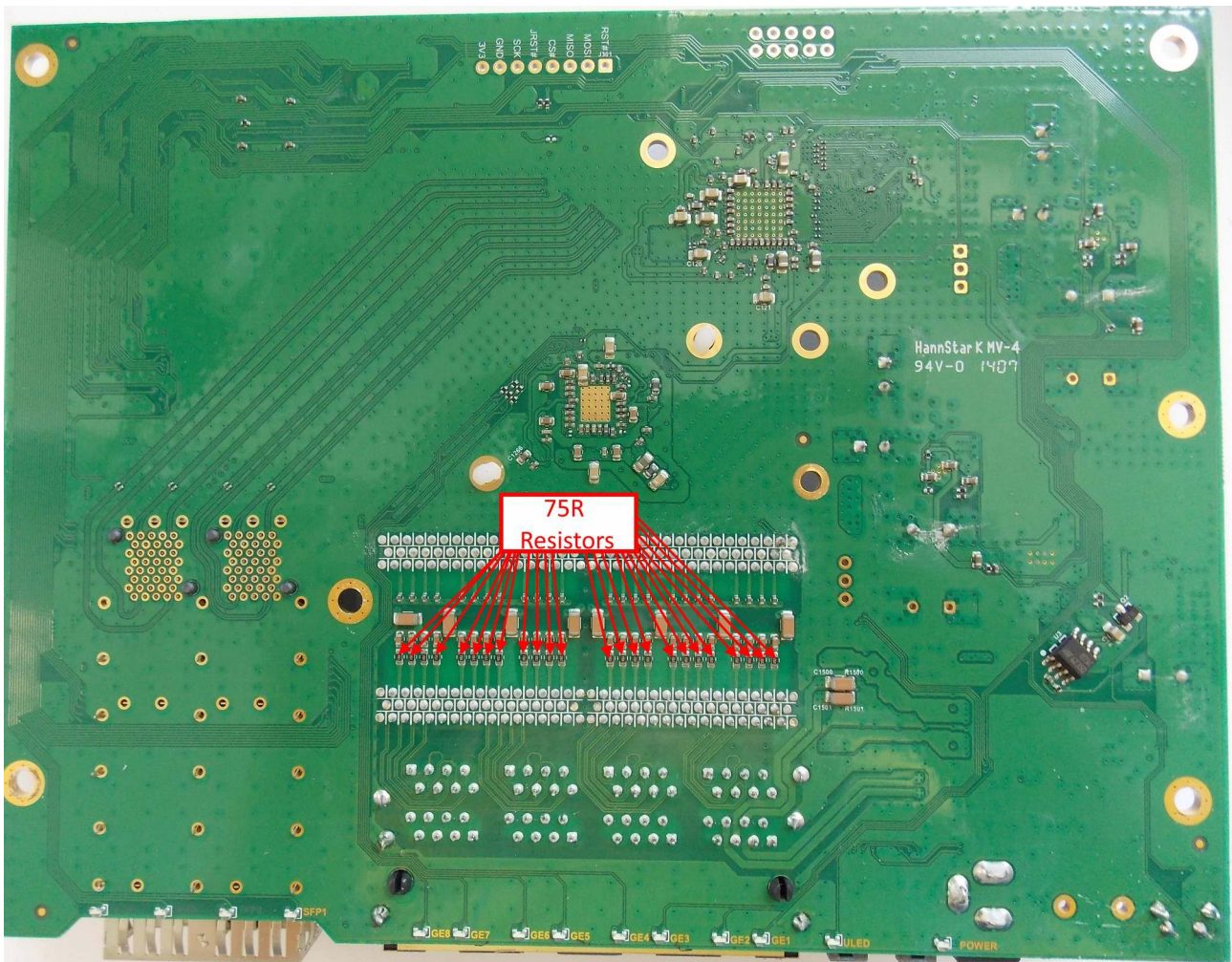

## CRS210-8G-2S+ series RouterBoards

---

### CRS210-8G-2S+IN



### Disassembling information

1. Step: use PH2 screw driver to loose backside screws, take off cover.

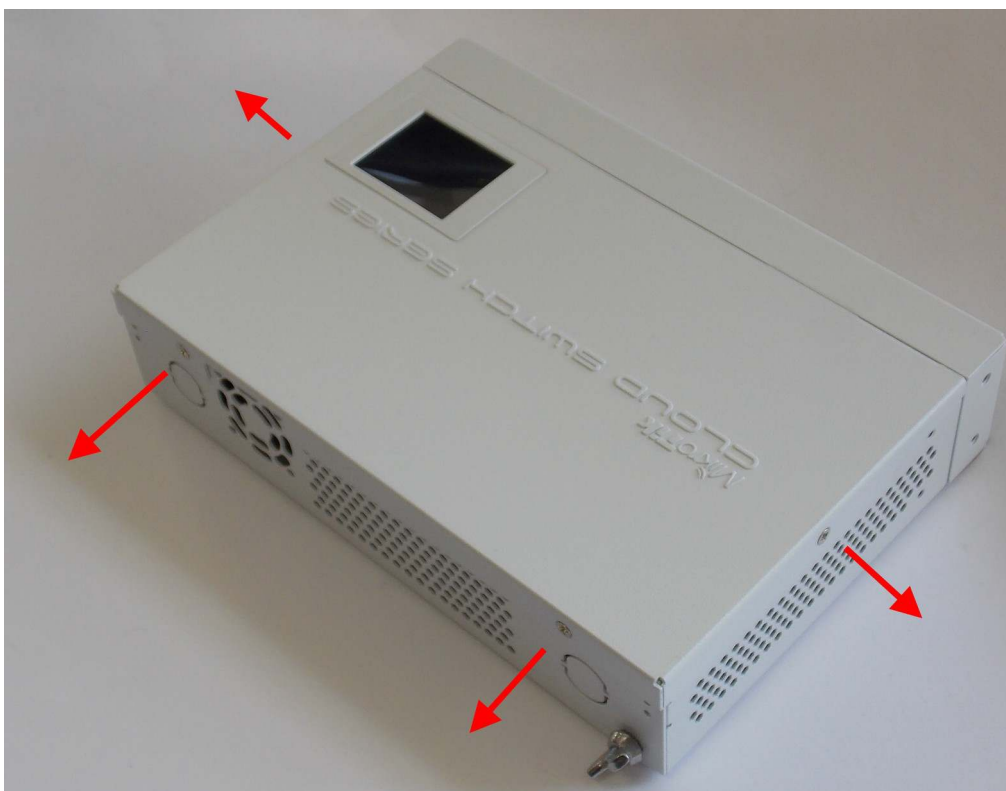

2. step: take off cover carefully, pay a tension to LCD connector. Push up both side of LCD connector from slot with “-” screwdriver as shown in next pictures

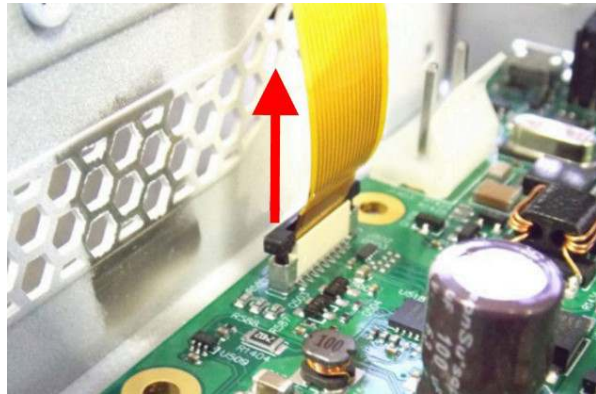

3. Step: use “+” screw driver to loose 7 pcs PCB screws, than take off PCB from case.

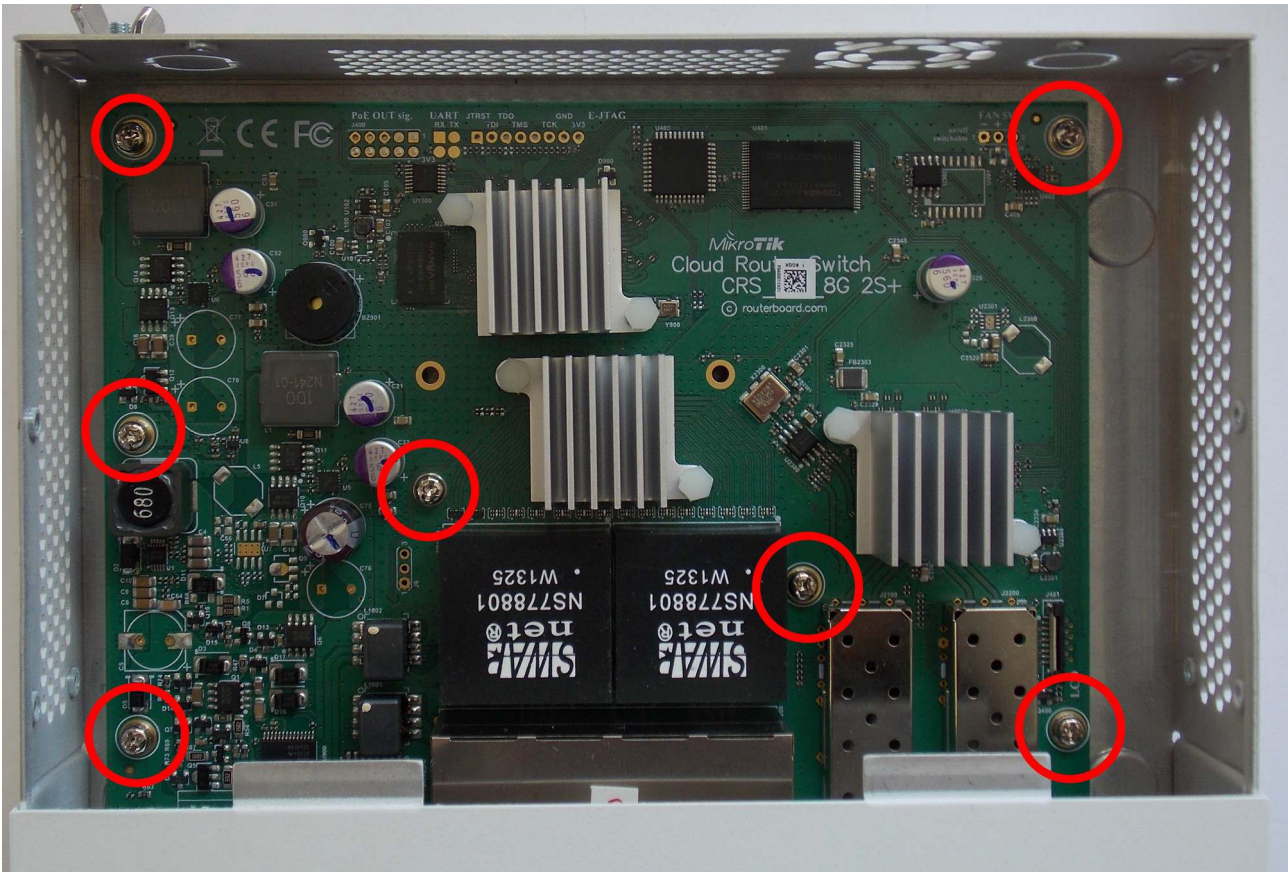

## Schottky diode measuring with multimeter in diode mode

Schottky diode reference numbers are D3, D5, D11, D16, D17. Voltage drop value should be about 0,215V

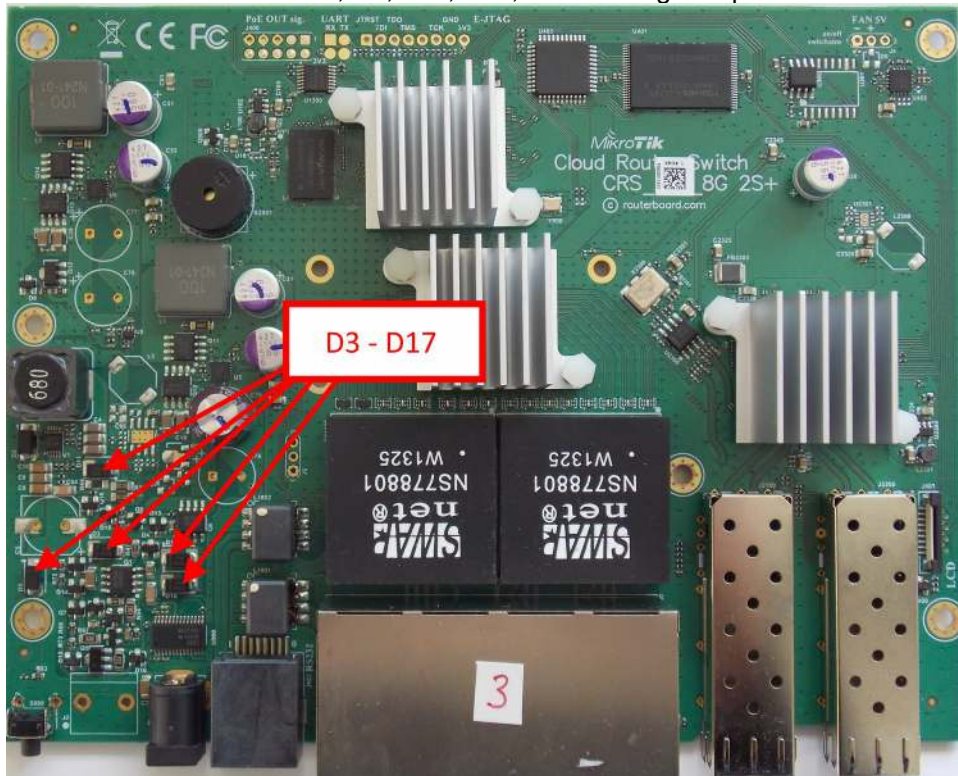

## Voltage drop between diode array pin#1 and Ground.

Check voltage drop between TR1200 and TR1201 Ethernet Transformers on ports Ether1 – Ether8 pins and Ground. Ether Pins are circled red. It should be in the range from 0,32V to 0,438V

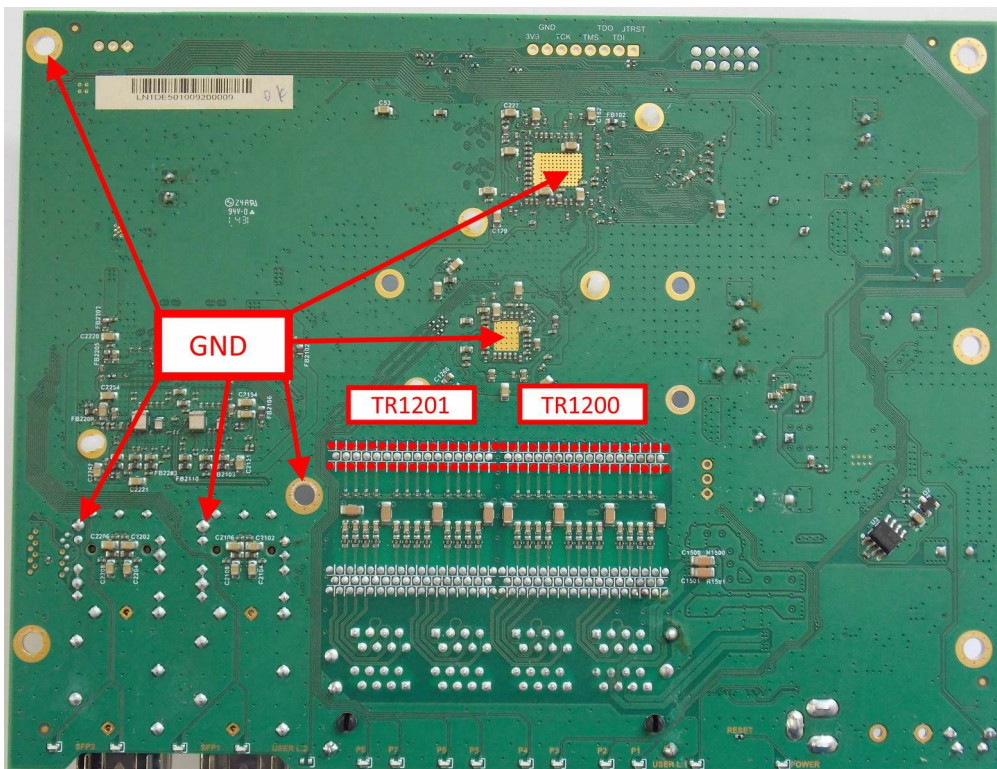

## CRS212-1G-10S-1S+ series RouterBoards

---

### CRS212-1G-10S-1S+IN

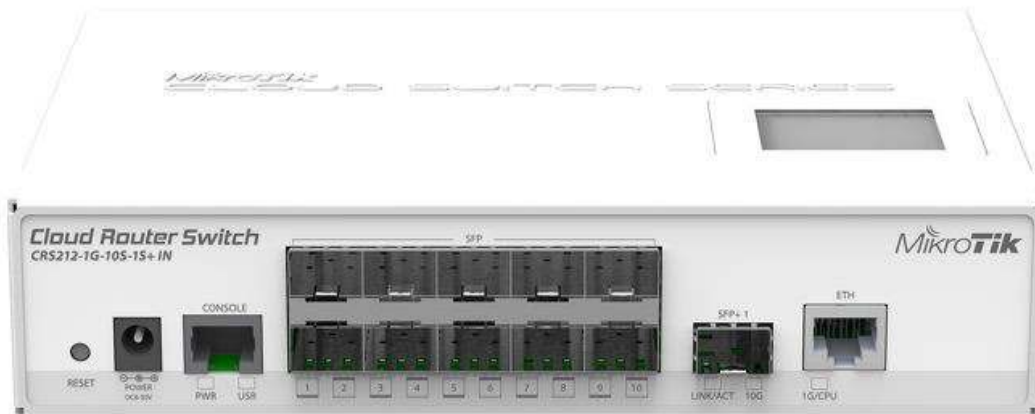

### Disassembling information

1. Step: use PH2 screw driver to loose backside screws, take off cover.

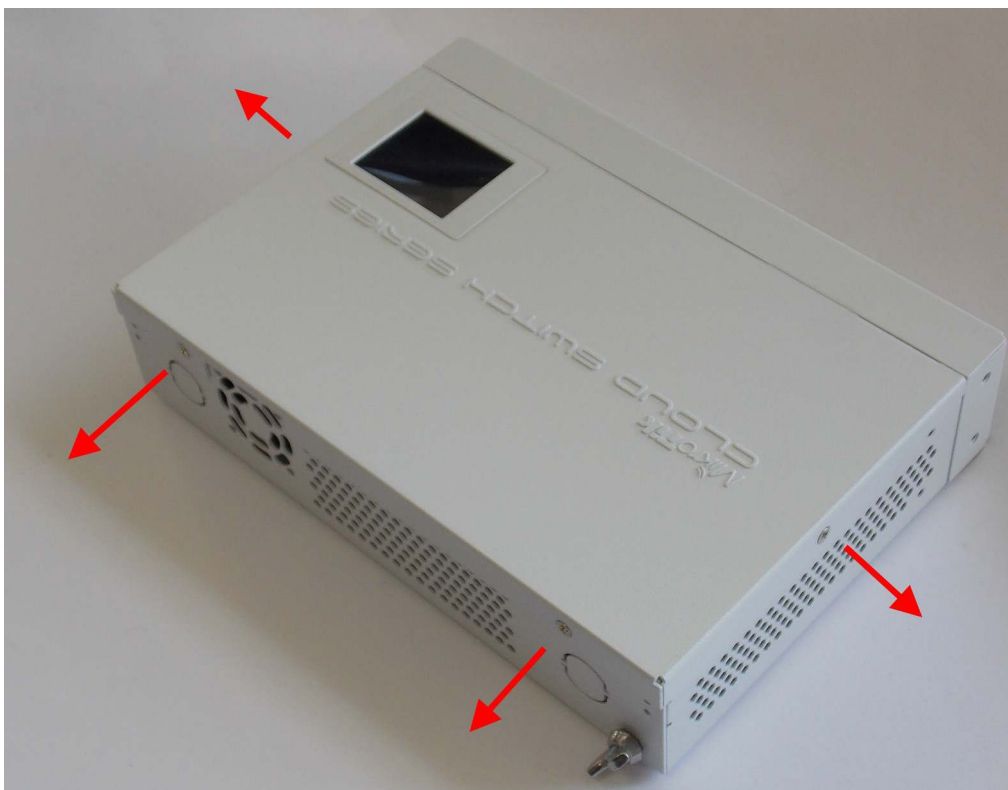

2. step: take off cover carefully, pay a tension to LCD connector. Push up both side of LCD connector from slot with “-” screwdriver as shown in next pictures

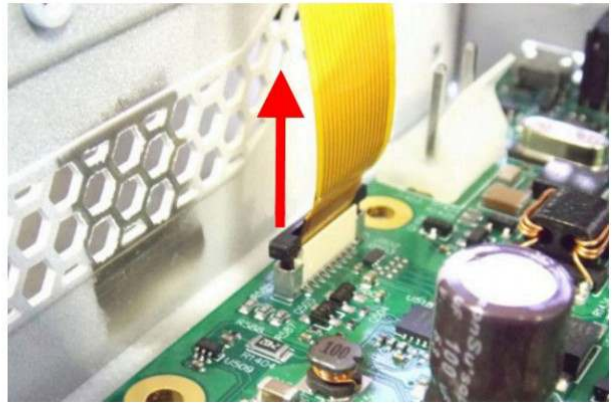

3. Step: use “+” screw driver to loose 7 pcs PCB screws, than take off PCB from case.

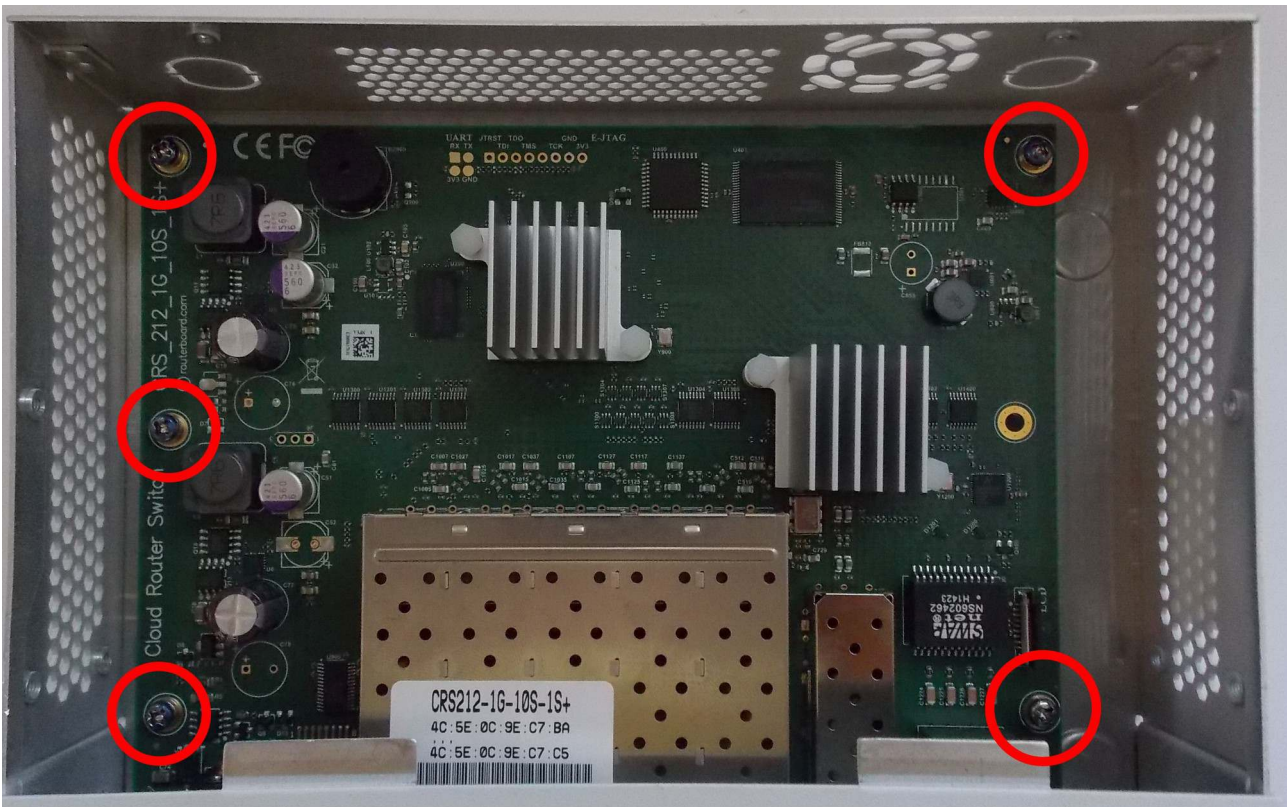

## Schottky diode measuring with multimeter in diode mode

Schottky diode reference numbers are D5. Voltage drop value should be about 0,215V



## Voltage drop between diode array pin#1 and Ground.

Check voltage drop between TRF1200 Ethernet Transformers on ports Ether1 pins and Ground. Ether Pins are marked with red arrows. It should be in the range from 0,32V to 0,438V

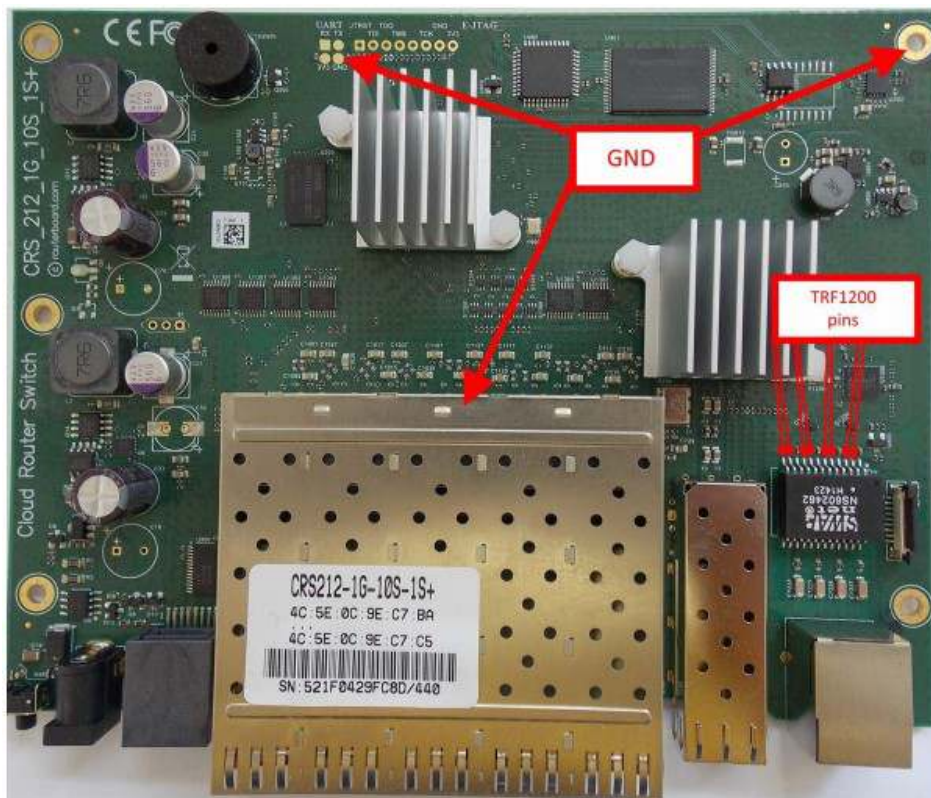

## 75R termination resistors resistance

Resistors marked with red arrows should be 75Ohm +/- 1%





## CRS109-8G-4S series RouterBoards

---

### CRS109-8G-1S-2HnD-IN



## Disassembling information

1. Step: use PH2 screw driver to loose backside screws, take off cover.
2. step: take off cover carefully, pay a tension to LCD connector. Push up both side of LCD connector from slot with “-” screwdriver as shown in next pictures

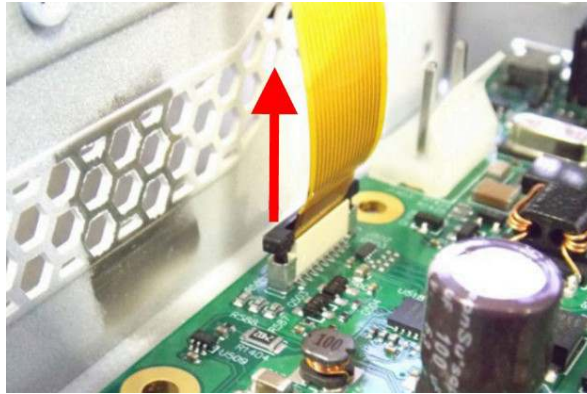

3. Step: use “+” screw driver to loose 7 pcs PCB screws, than take off PCB from case.

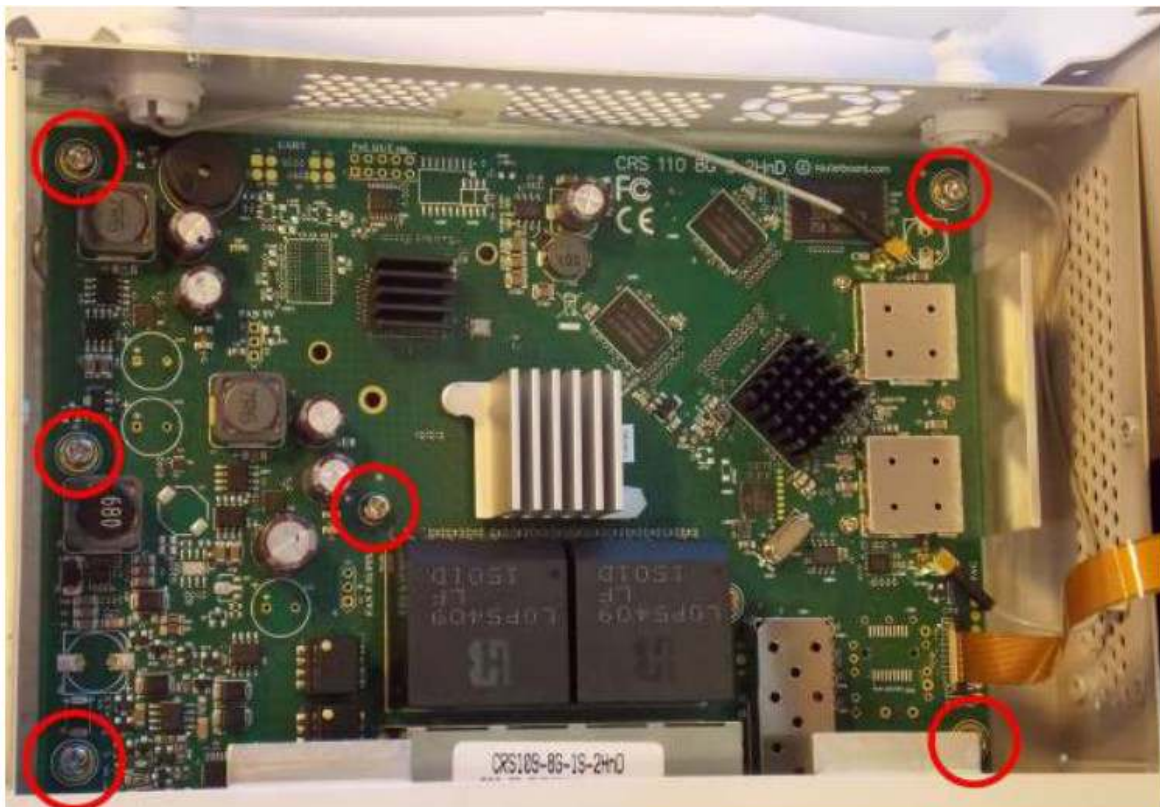

## Schottky diode measuring with multimeter in diode mode

Schottky diode reference numbers are D3, D5, D11, D16, D17. Voltage drop value should be about 0,215V

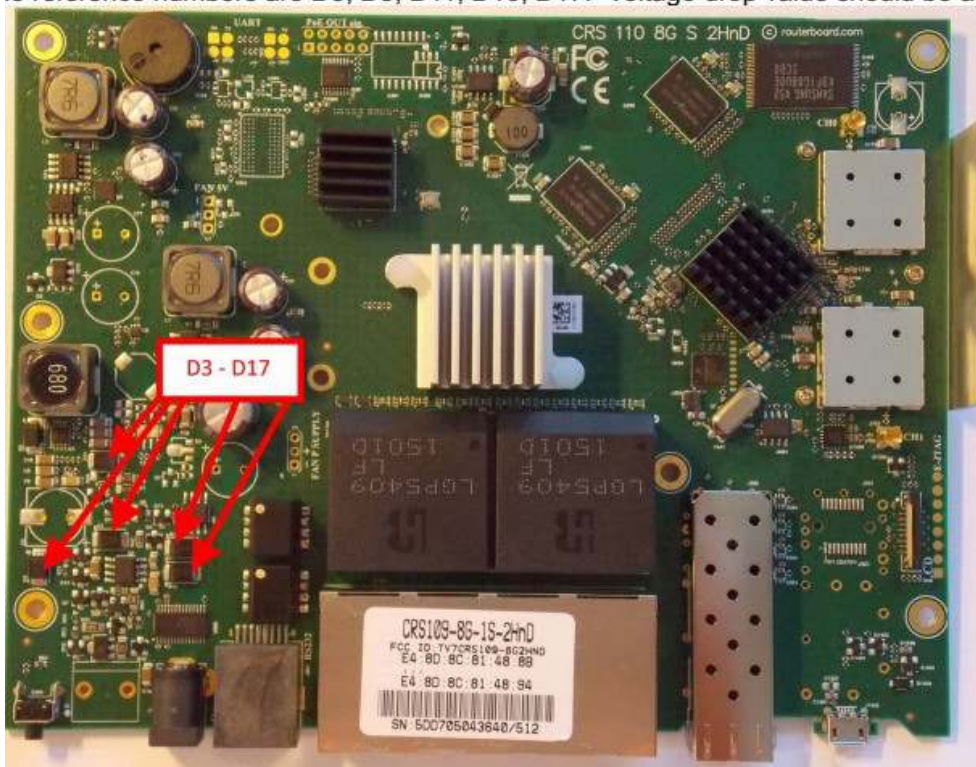

## Voltage drop between diode array pin#1 and Ground.

Check voltage drop between TR1200 and TR1201 Ethernet Transformers on ports Ether1 – Ether8 pins and Ground. Ether Pins are circled red. It should be in the range from 0,32V to 0,438V

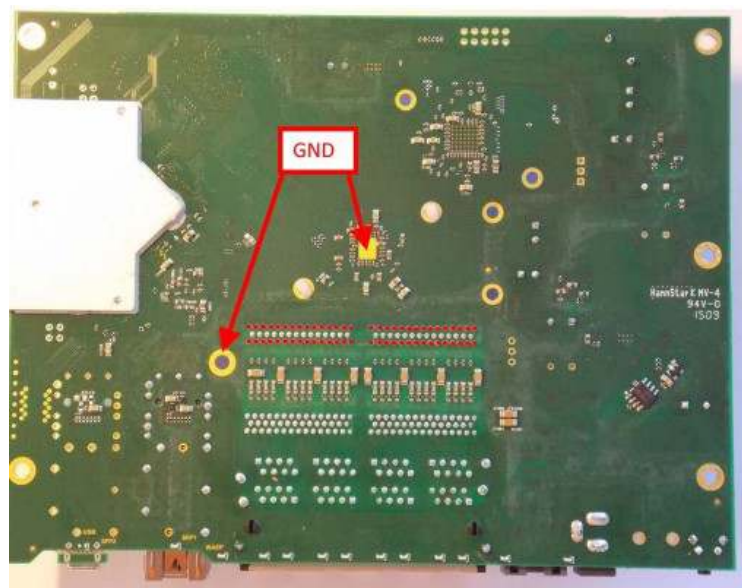

## 75R termination resistors resistance

Resistors marked with red arrows should be 75Ohm +/- 1%

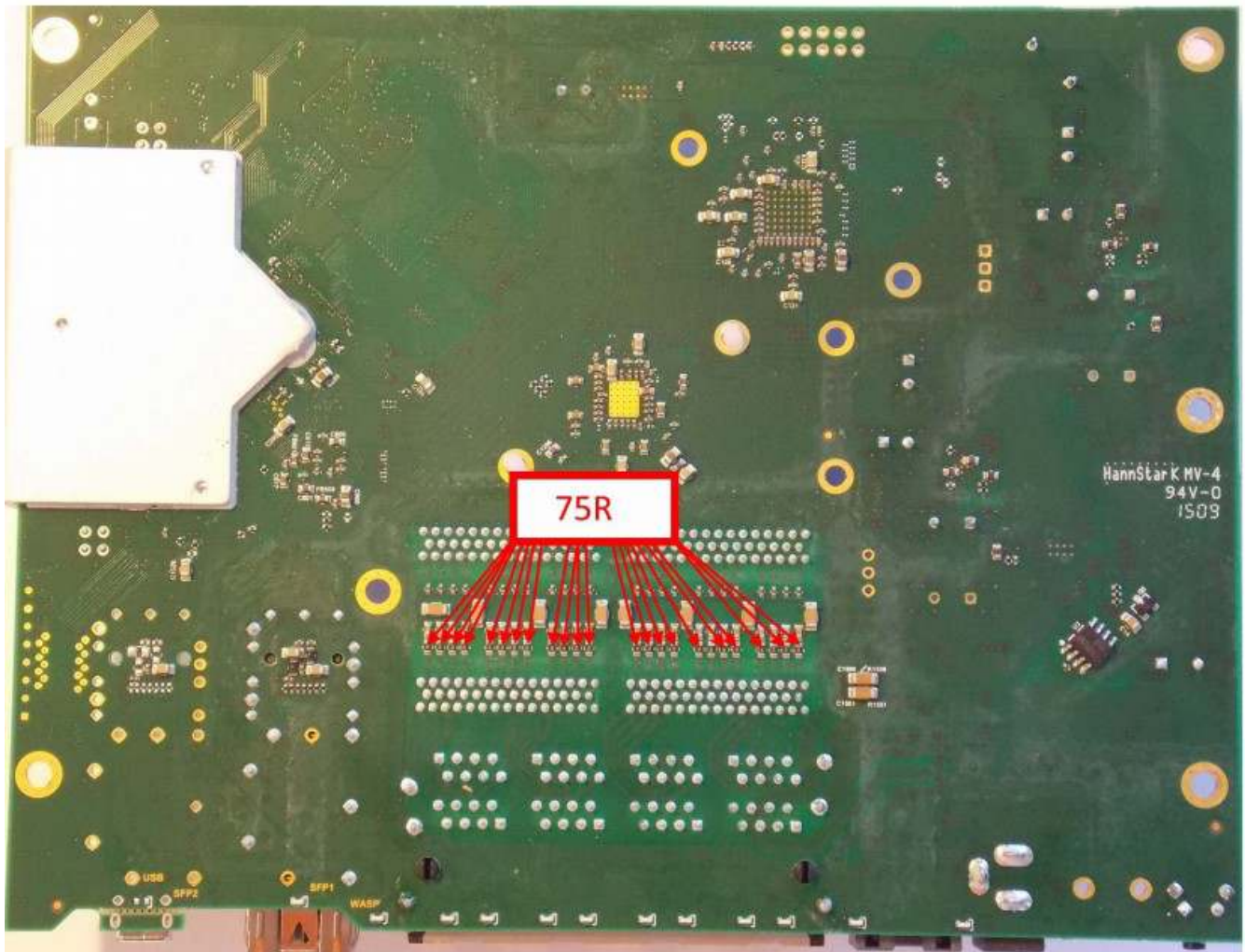

## CRS226-24G-2S+ series RouterBoards

---

### CRS226-24G-2S+IN

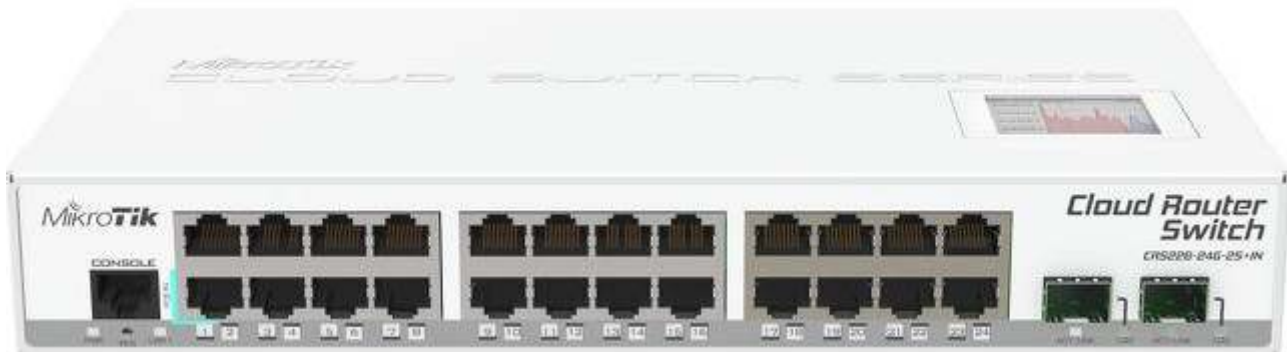

### CRS226-24G-2S+RM

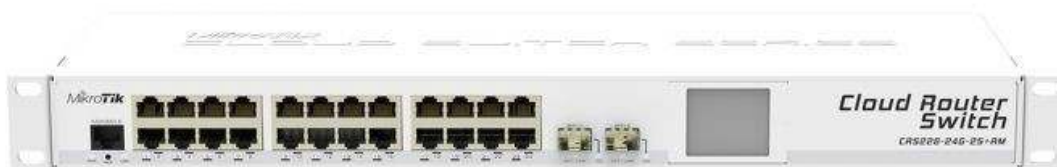

## Disassembling information

1. Step: use PH2 screw driver to loose backside screws, take off cover.
2. step: take off cover carefully, pay a tension to LCD connector. Push up both side of LCD connector from slot with “-” screwdriver as shown in next pictures

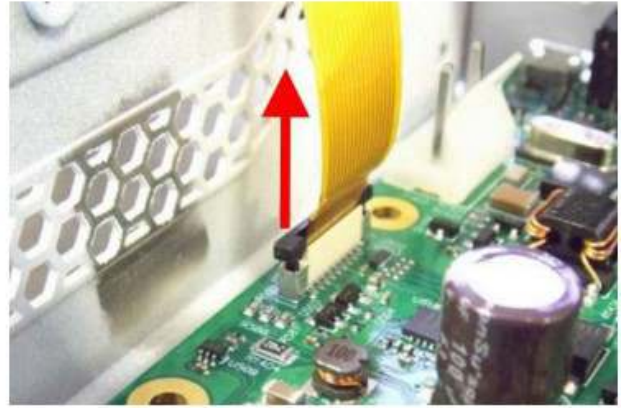

3. Step: use “+” screw driver to loose 7 pcs PCB screws, than take off PCB from case.

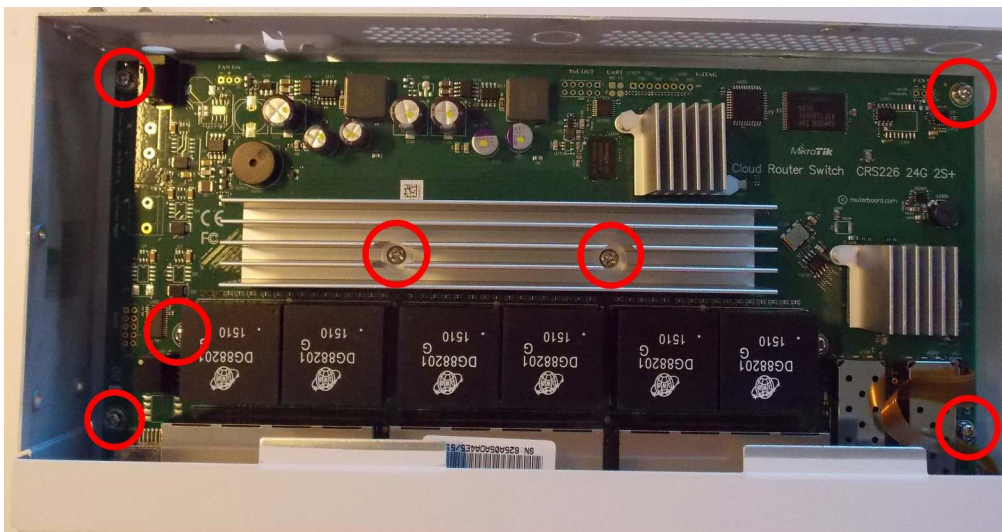

## Schottky diode measuring with multimeter in diode mode

Schottky diode reference numbers are D1, D4, D5. Voltage drop value should be about 0,215V



## Voltage drop between diode array pin#1 and Ground.

Check voltage drop between TR1200 and TR1201 Ethernet Transformers on ports Ether1 – Ether8 pins and Ground. Ether Pins are circled red. It should be in the range from 0,32V to 0,438V

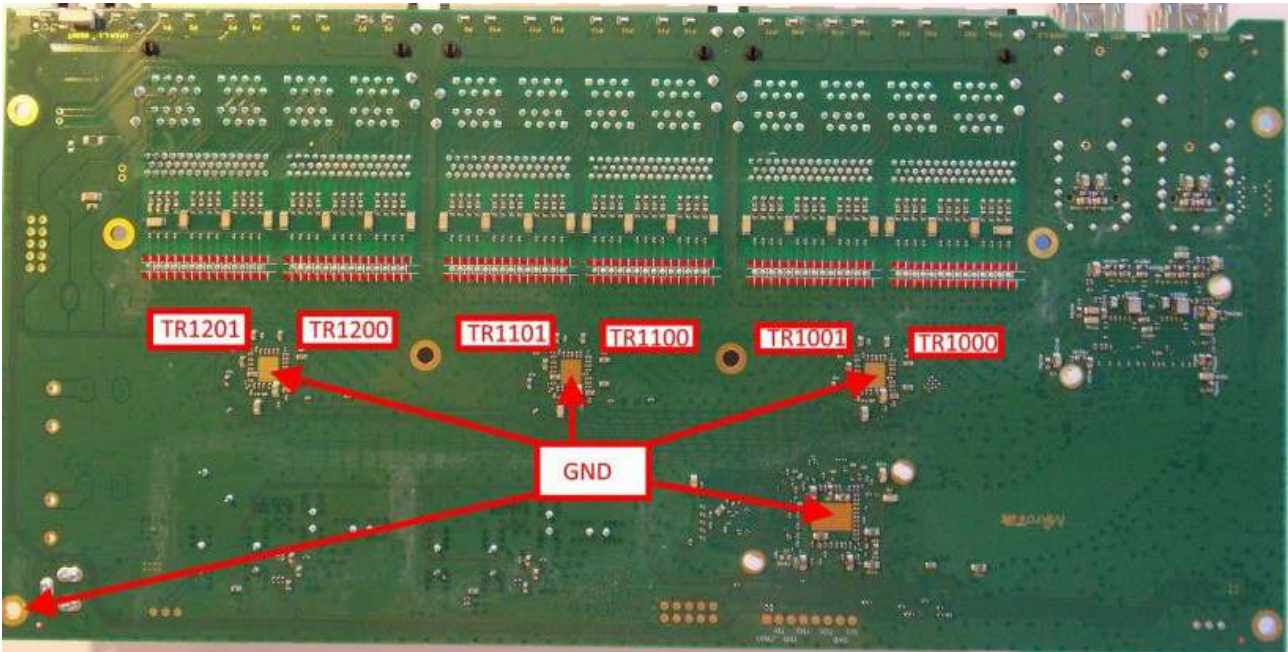

## 75R termination resistors resistance

Resistors marked with red arrows should be 75Ohm +/- 1%

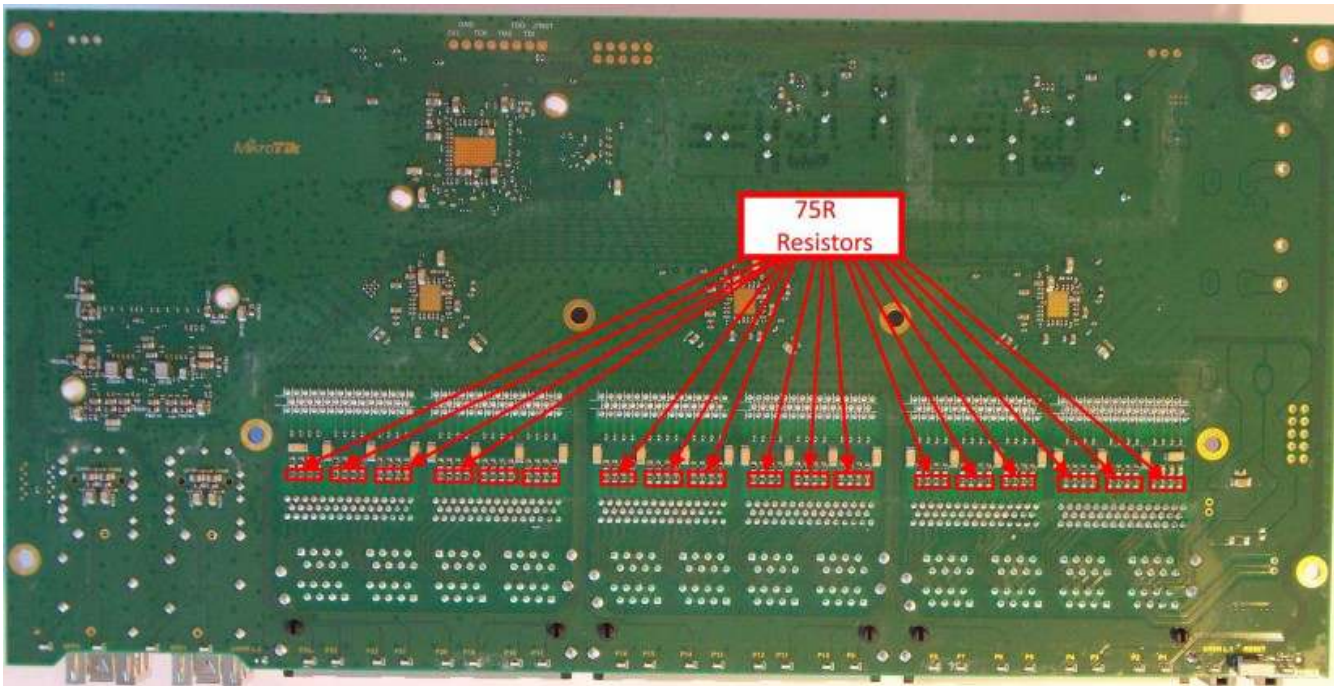



## CRS125-24G-1S series

---

List of Cloud Router Switch CRS125-24G-1S series:

### CRS125-24G-1S-IN



### CRS125-24G-1S-RM



### CRS125-24G-1S-2HnD-IN

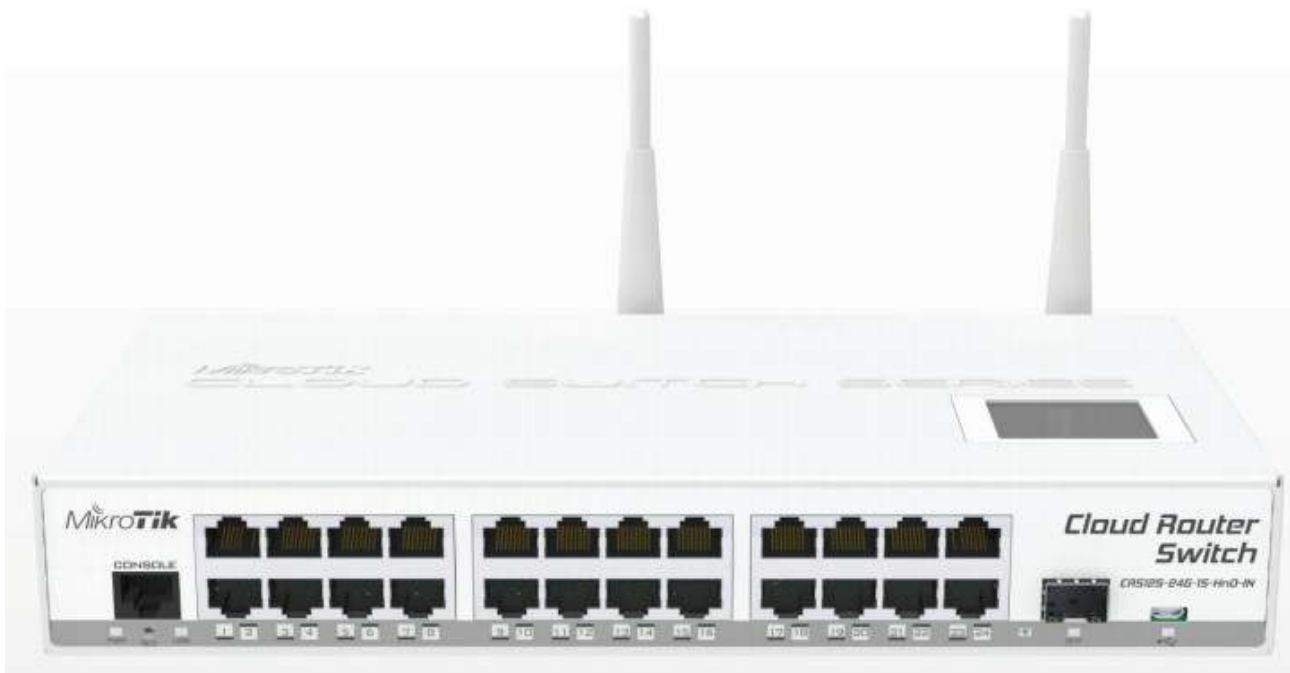

## Disassembling information



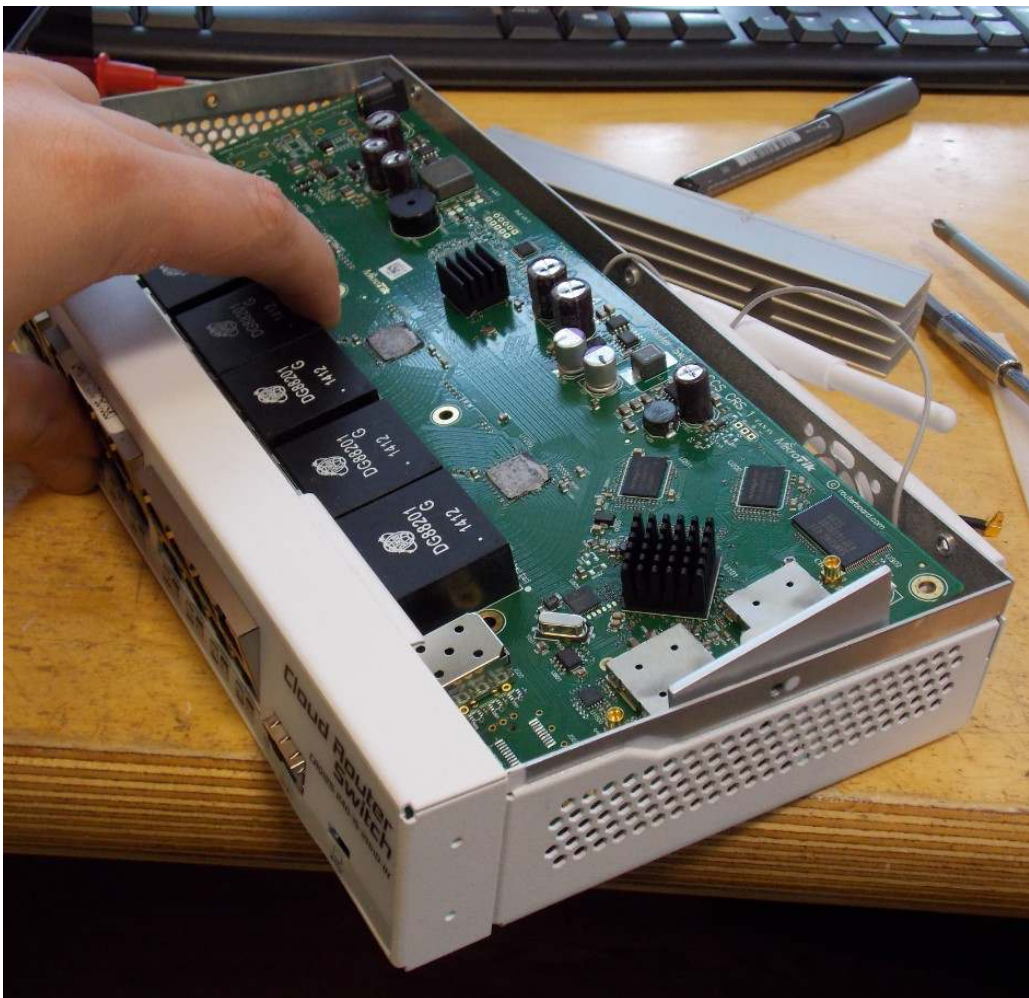
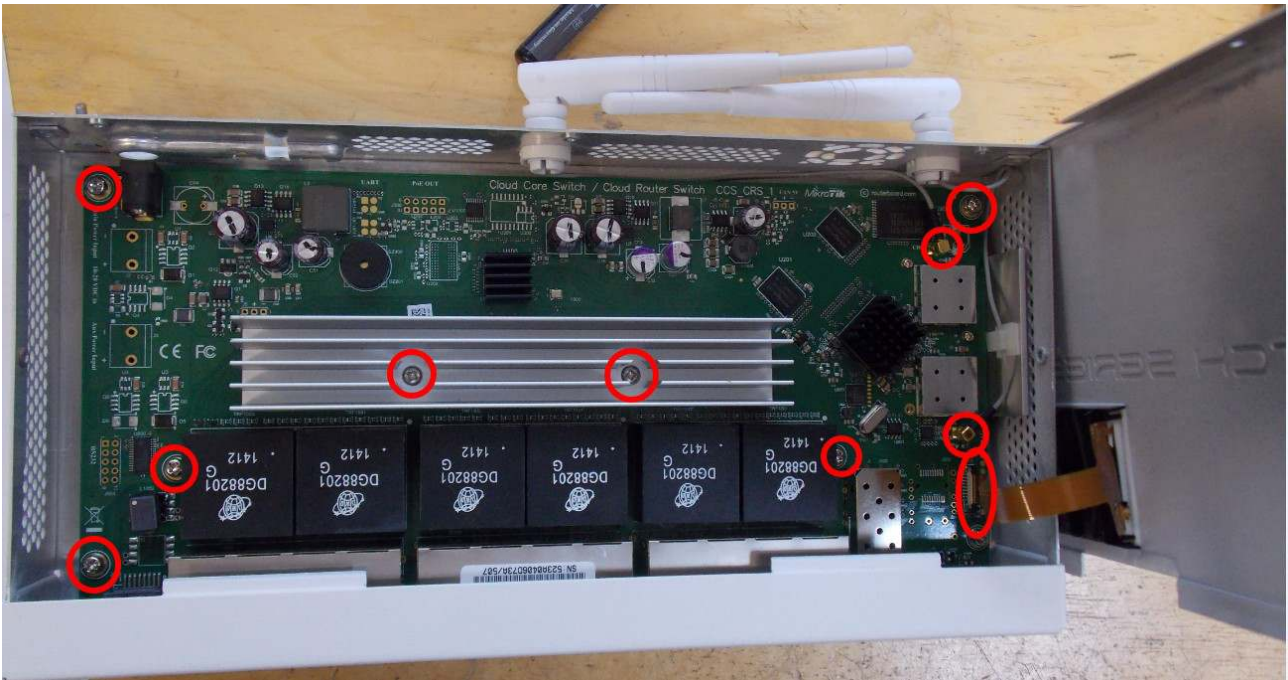

## Schottky diode measuring with multimeter in diode mode

Schottky diode reference numbers is D1 and D5; Voltage drop value should be about 0,208V

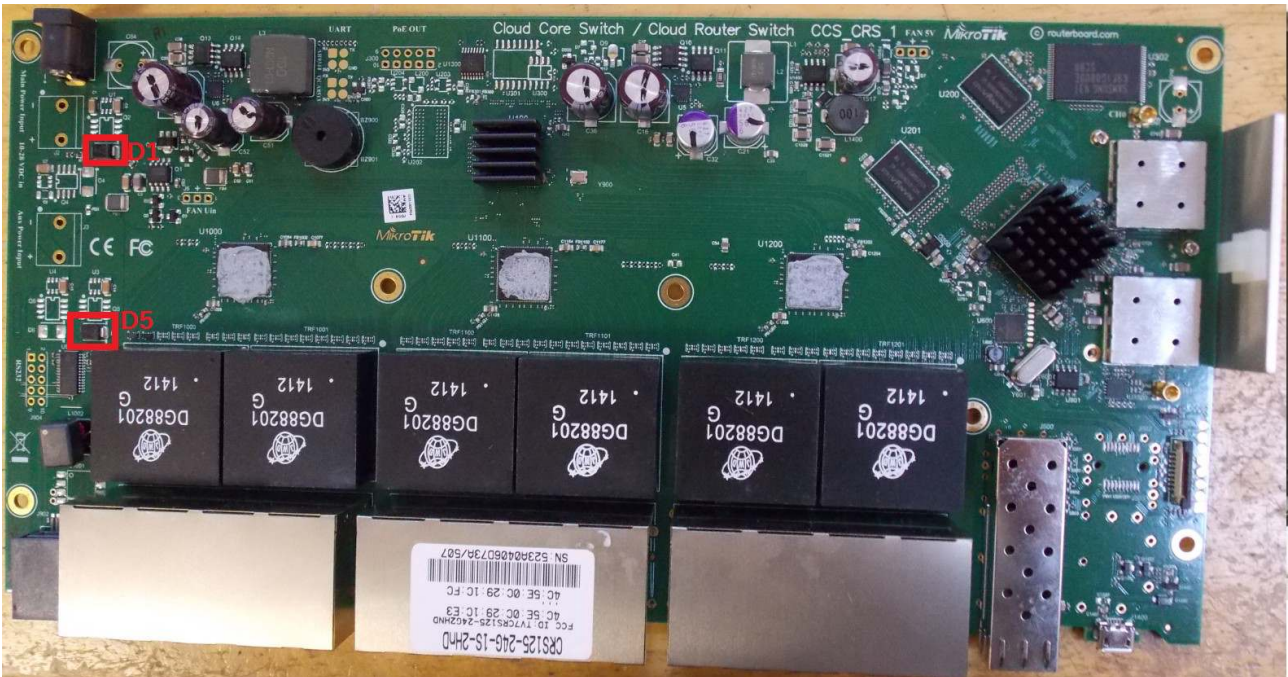

## Voltage drop between diode array pin#1 and Ground.

Check voltage drop between Transformer TRF1000, TRF1001, TRF1100, TRF1101, TRF1200 and TR1201 pins and Ground.

It should be in the range from 0,32V to 0,438V

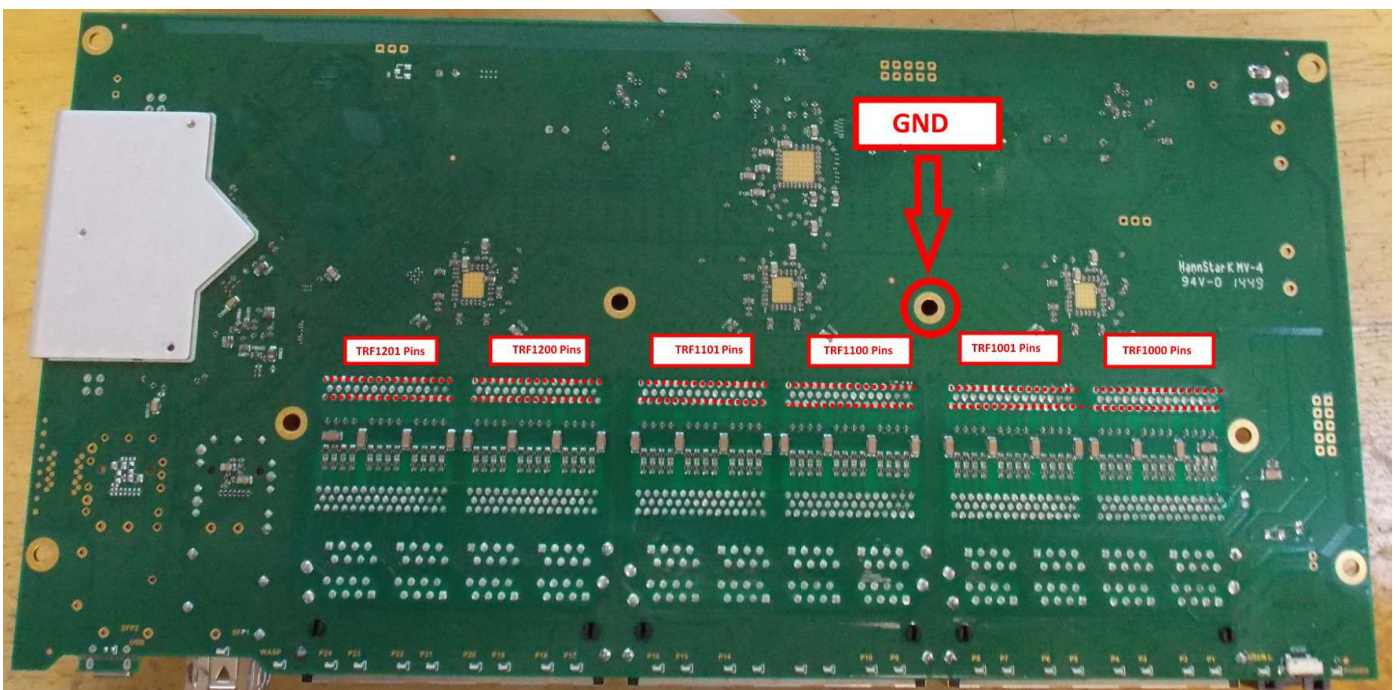

## Termination resistors resistance in RJ-45 connector

Red circled resistors resistance should be 750hm +/- 1%

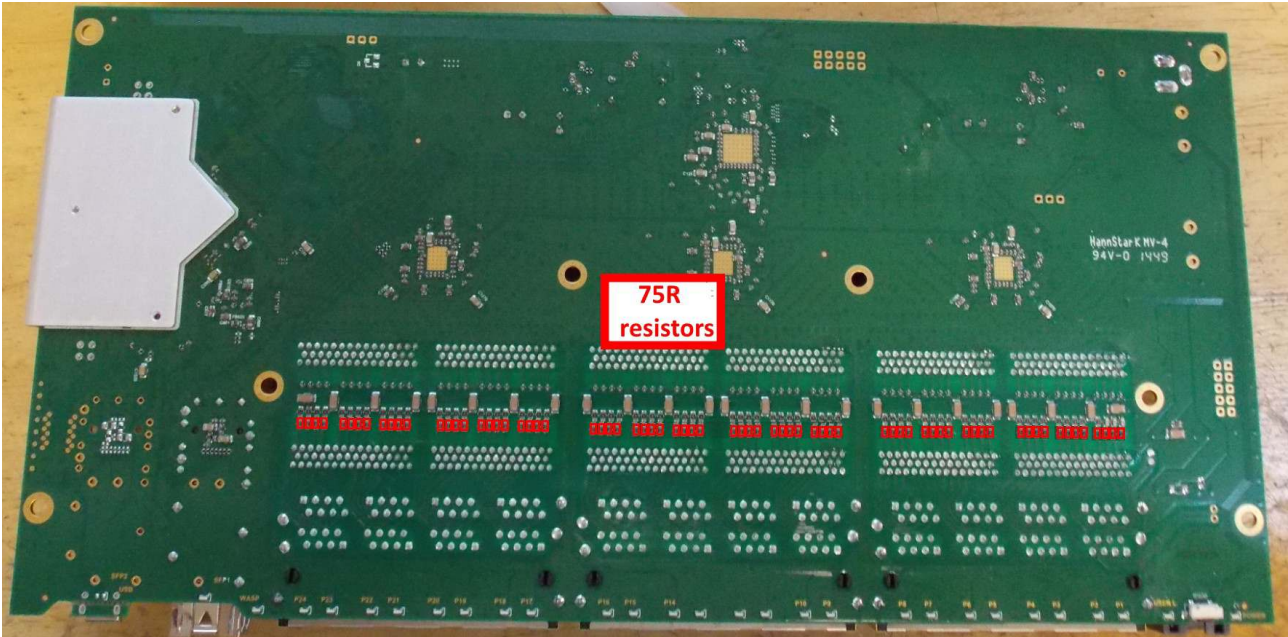

On ports Ether2 – Ether24 You can take patch cord and plug it into the routerboard, and then measure resistance of termination resistors.

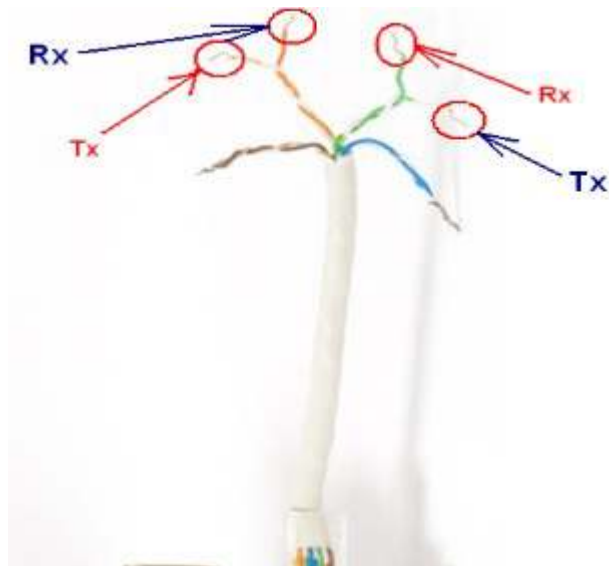

Resistance value between Rx and Tx line must be 150 Ohm +/-4%.

If resistance value is smaller or higher then Tx/Rx line was damaged by high voltage surge.

## RB911-2Hn series RouterBoards

---

### 911 Lite2

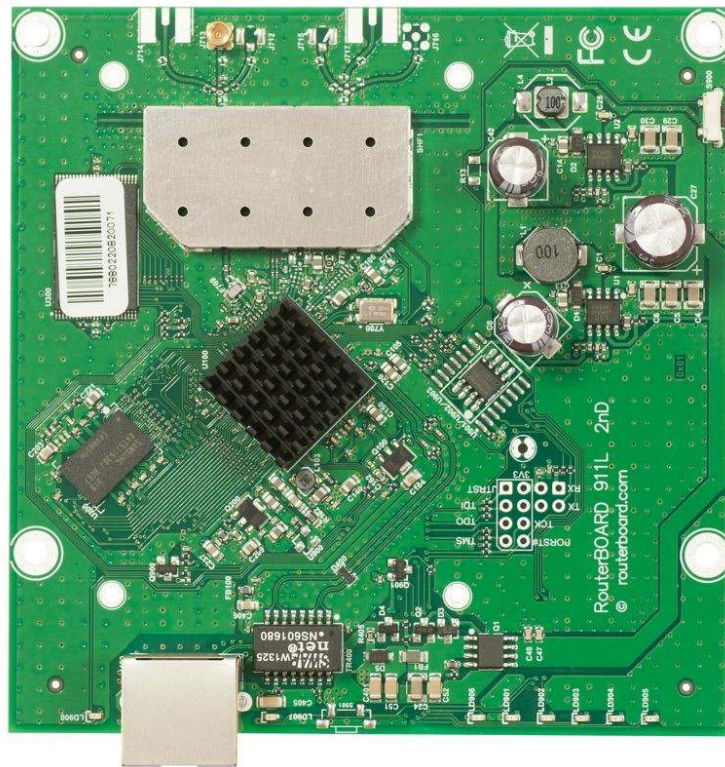

## Schottky diode measuring with multimeter in diode mode

Schottky diode reference numbers D5. Voltage drop value should be about 0,215V

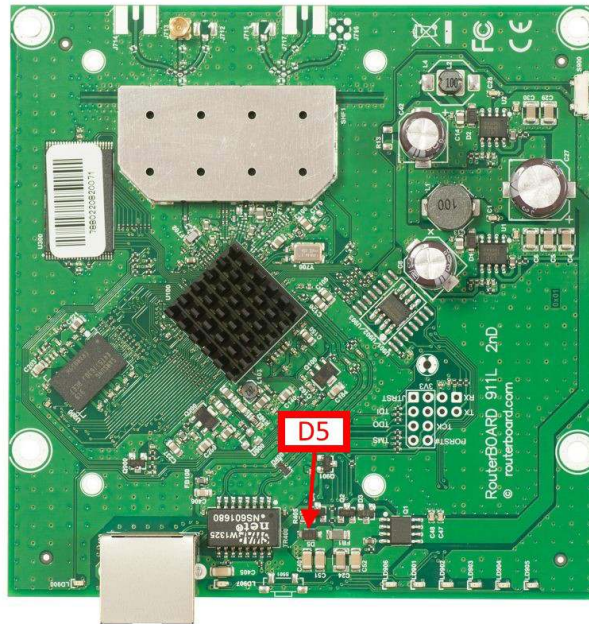

## Voltage drop between diode array pin#1 and Ground.

Check voltage drop between TR400 Ethernet Transformers on ports Ether1 pins and Ground. Ether Pins are marked with red arrows.

It should be in the range from 0,32V to 0,438V

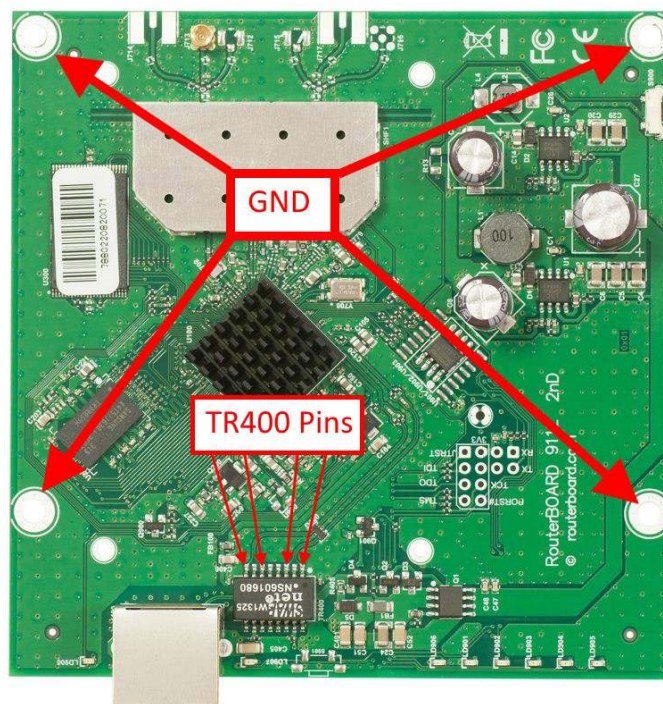

## 75R termination resistors resistance

Resistors marked with red arrows should be 75Ohm +/- 1%

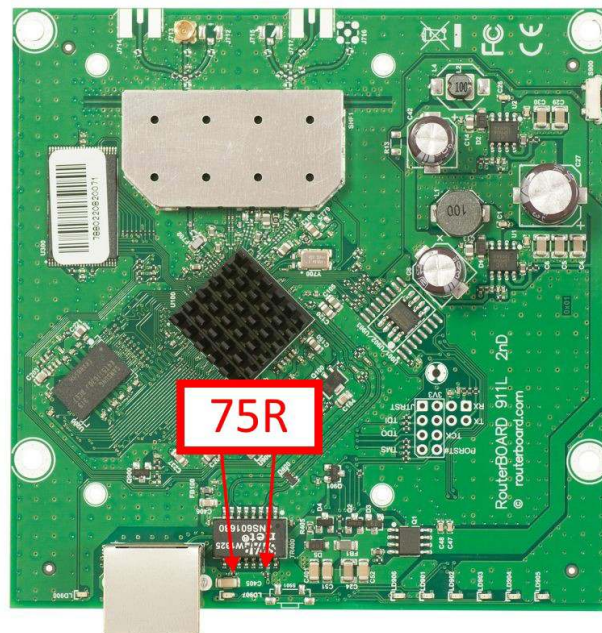



# RB911-5Hn series RouterBoards

---

## 911 Lite5

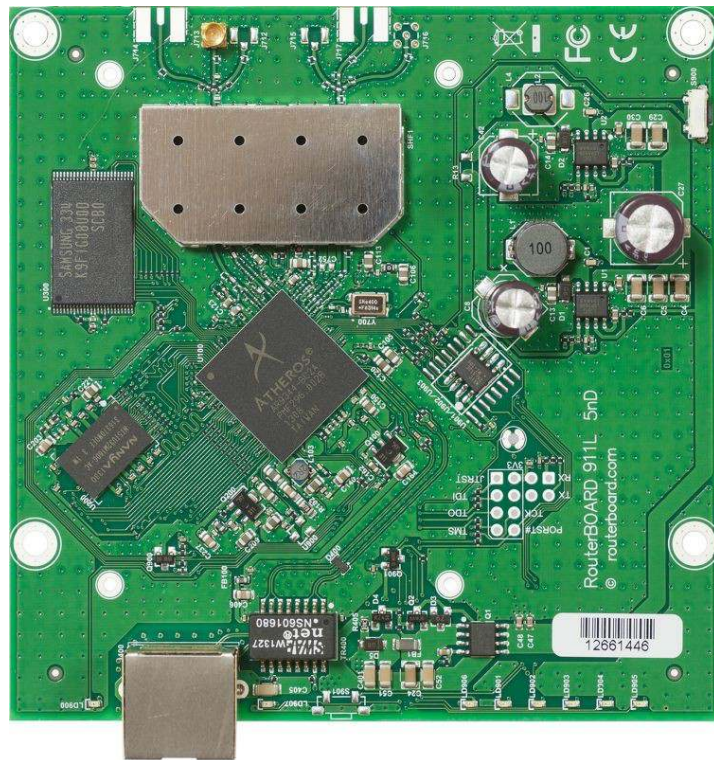

## Schottky diode measuring with multimeter in diode mode

Schottky diode reference numbers D5. Voltage drop value should be about 0,215V

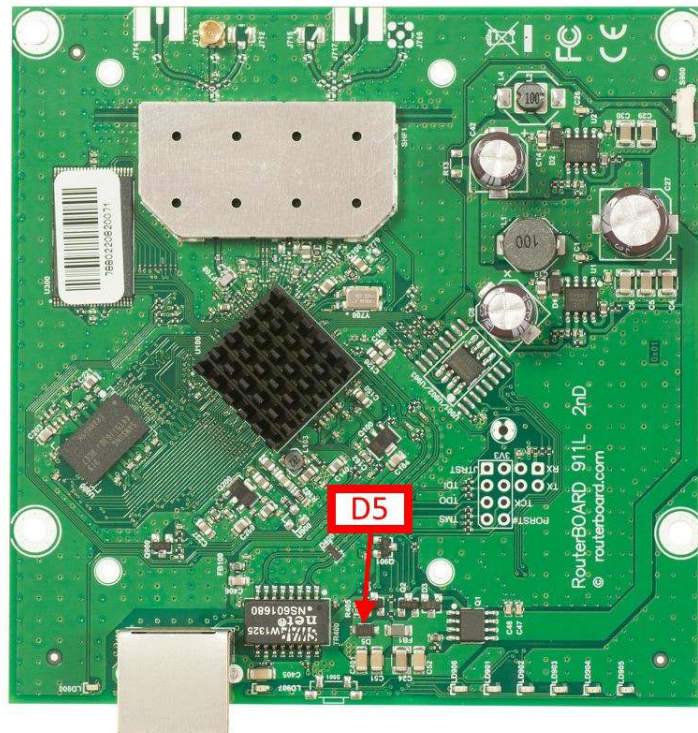

## Voltage drop between diode array pin#1 and Ground.

Check voltage drop between TR400 Ethernet Transformers on ports Ether1 pins and Ground. Ether Pins are marked with red arrows. It should be in the range from 0,32V to 0,438V

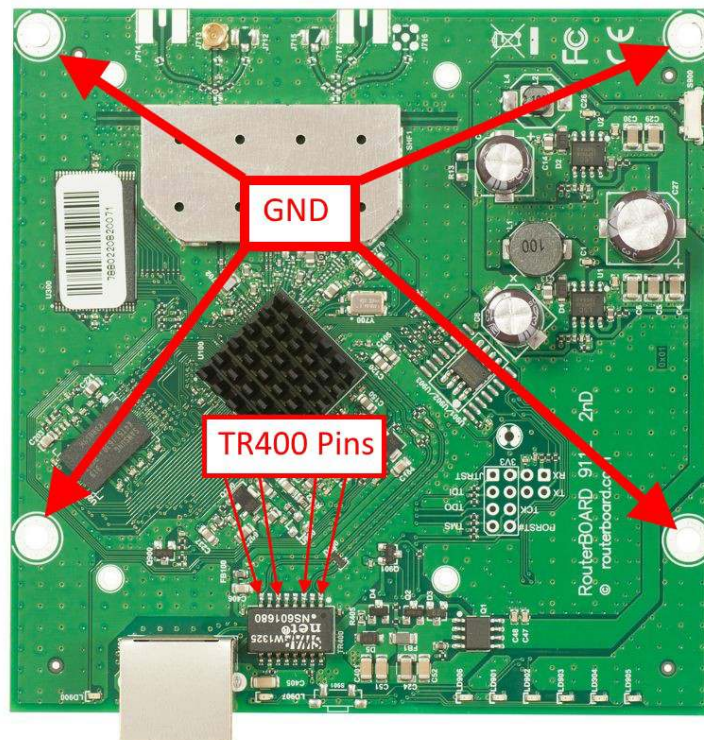

## 75R termination resistors resistance

Resistors marked with red arrows should be 75Ohm +/- 1%

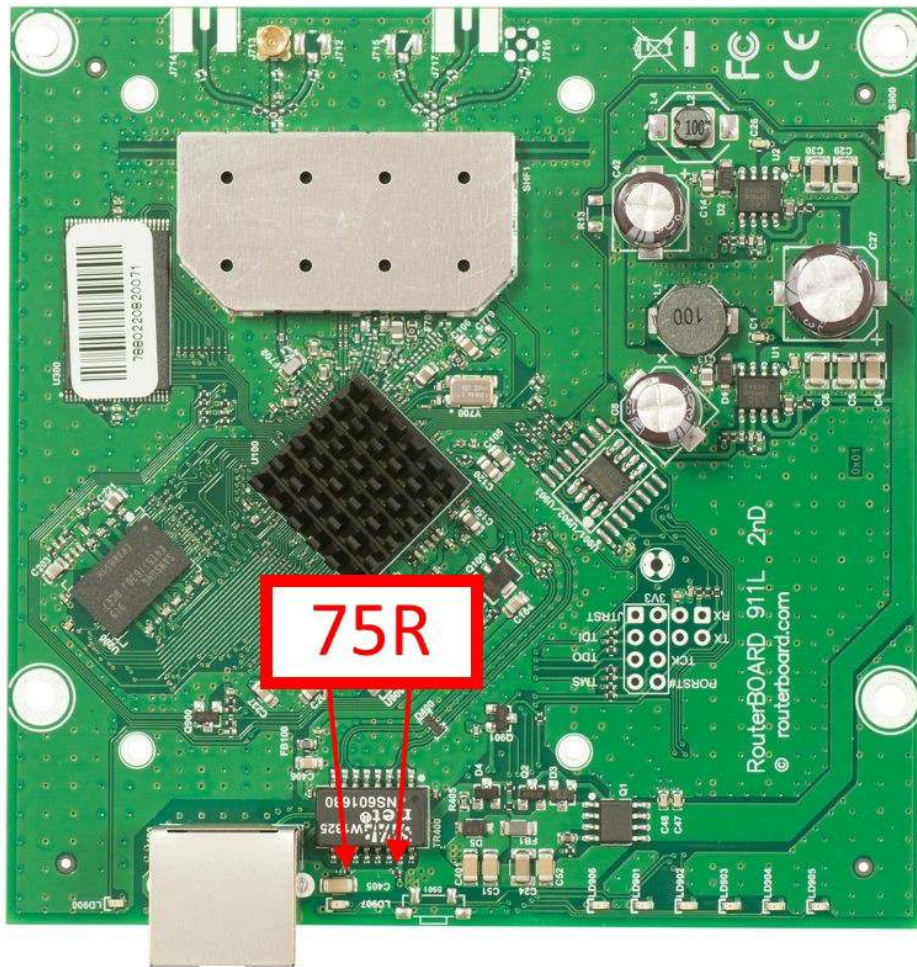

## RBFTC11 series RouterBoards

---

### FTC



### Disassembling information

1. step: use screw driver to loose 1 pcs cover screw, then take off cover.



2. step: use PH2 and TX8 screw driver to loose screws.



3. Step: take off cover with board.



## Schottky diode measuring with multimeter in diode mode

Schottky diode reference numbers D110, D112. Voltage drop value should be about 0,215V

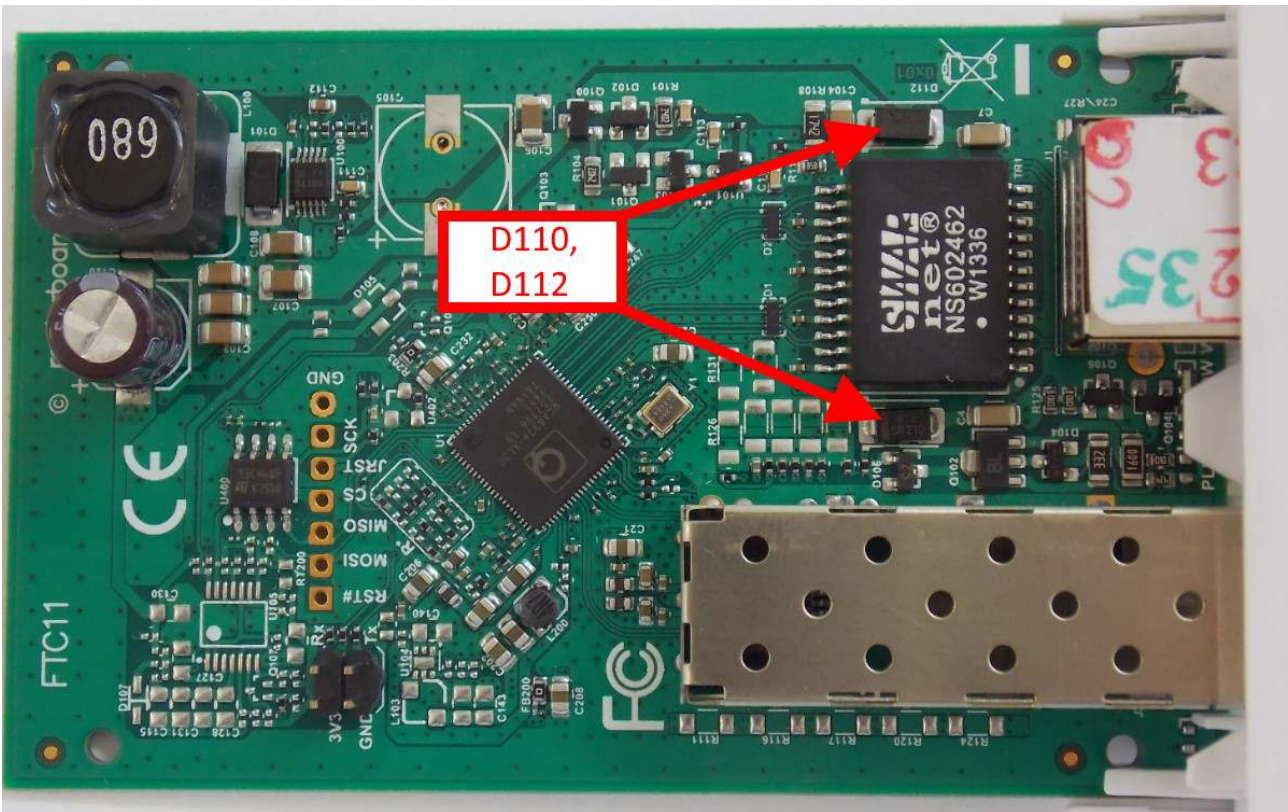

## Voltage drop between diode array pin#1 and Ground.

Check voltage drop between TR400 Ethernet Transformers on ports Ether1 pins and Ground. Ether Pins are marked with red arrows.

It should be in the range from 0,32V to 0,438V

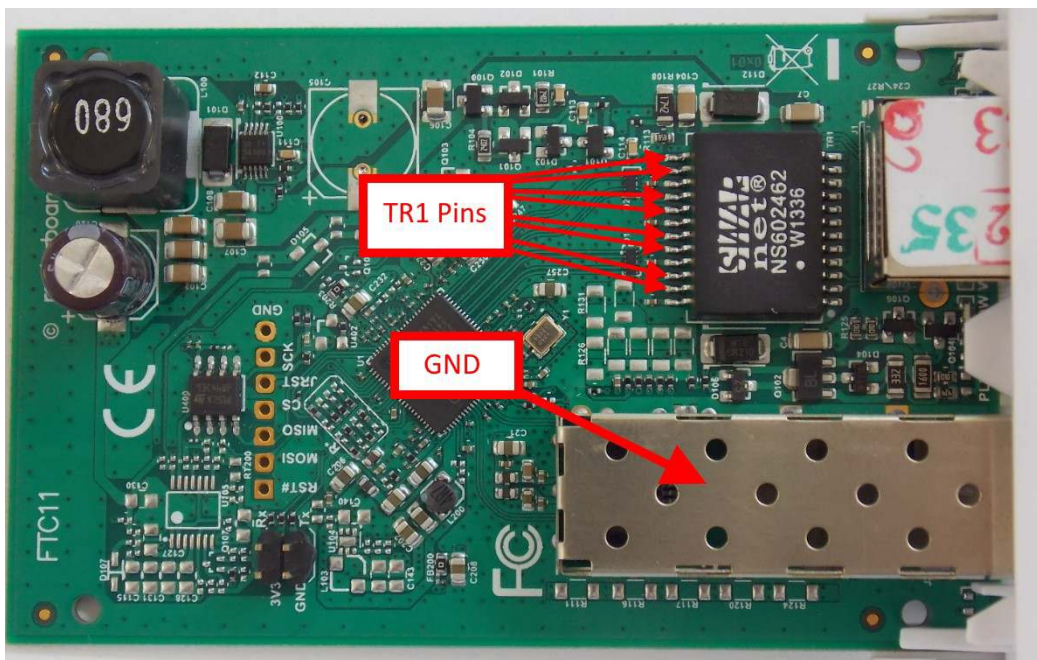

## RBwAP series RouterBoards

---

### wAP



### Disassembling information

1. step: use screw driver to loose 1 pcs cover screw, then take off cover.



2. step: use PH2 and TX8 screw driver to loose screws.



3. Step: take off cover with board.





## Schottky diode measuring with multimeter in diode mode

Schottky diode reference numbers are D1, D2, D4; Voltage drop value should be about 0,197V  
Diode bridges reference numbers is D5. Voltage drop value should be about 0,511V

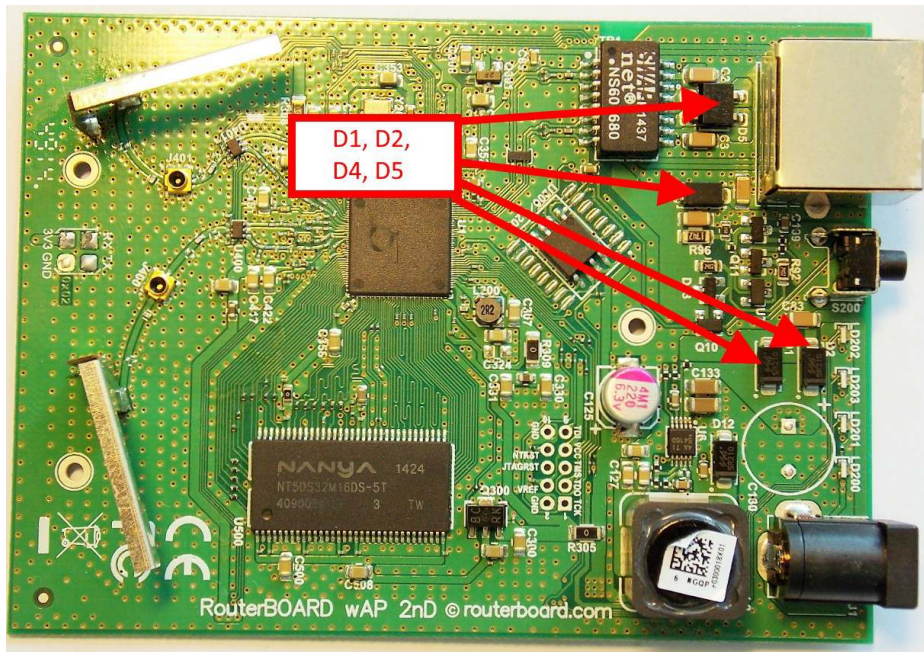

## Voltage drop between diode array pin#1 and Ground.

Check voltage drop between TR400 Ethernet Transformers on ports Ether1 pins and Ground. Ether Pins are marked with red arrows. It should be in the range from 0,32V to 0,438V

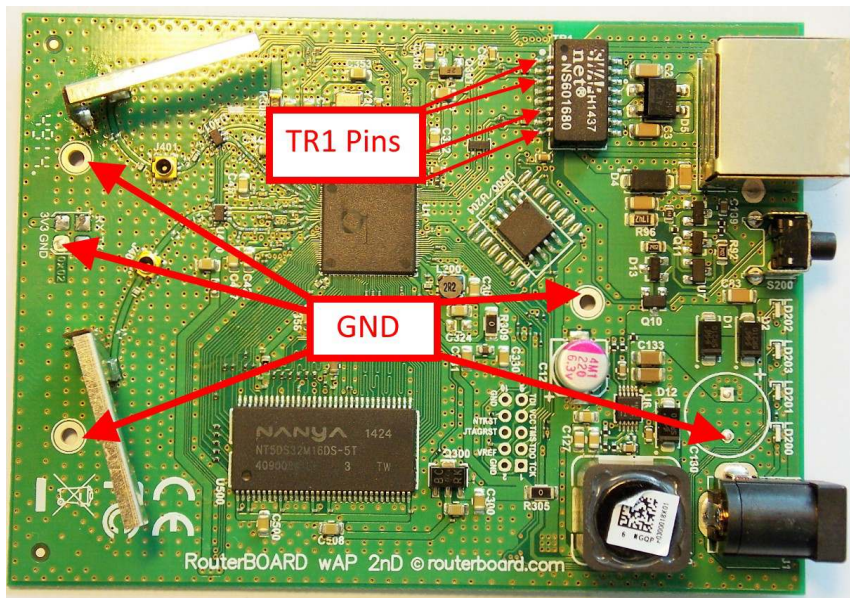

## RB260GSP series RouterBoards

---

### RB260GSP

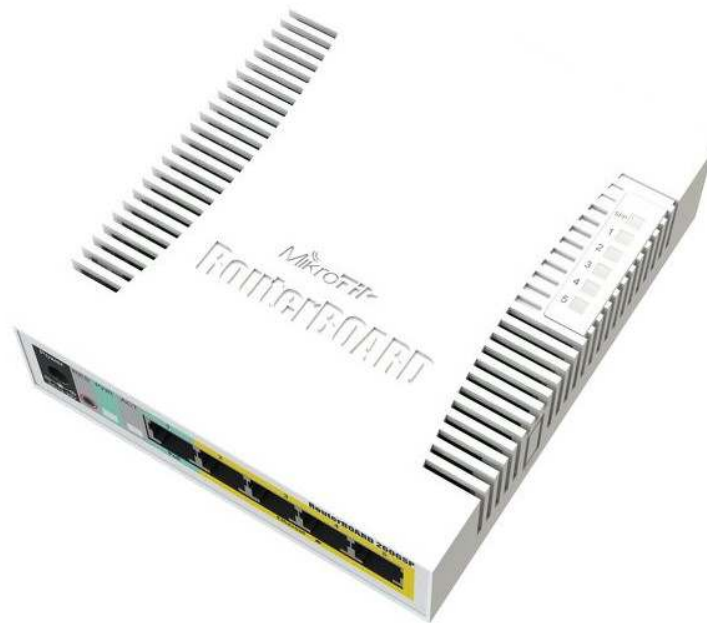

### RB260GS



## Disassembling information

1. Take off the cover with a screwdriver as shown in the pictures



2. Take out the board with a screwdriver as shown in the picture



## Schottky diode measuring with multimeter in diode mode

Diode bridge reference numbers are D1, D2, D3, D7, D17. Voltage drop value should be about 0,222V

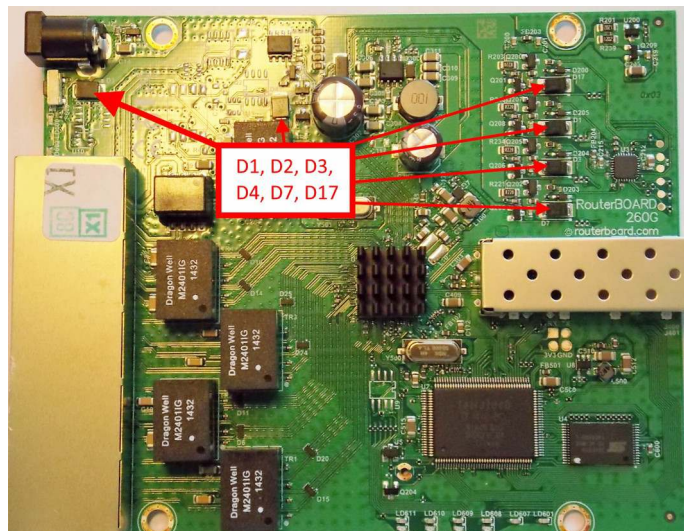

## Voltage drop between diode array pin#1 and Ground.

Check voltage drop between TR1, TR2, TR3, TR4, TR5 Ethernet Transformers on ports Ether1 – Ether5 pins and Ground. Ether Pins are marked with red.

It should be in the range from 0,32V to 0,438V

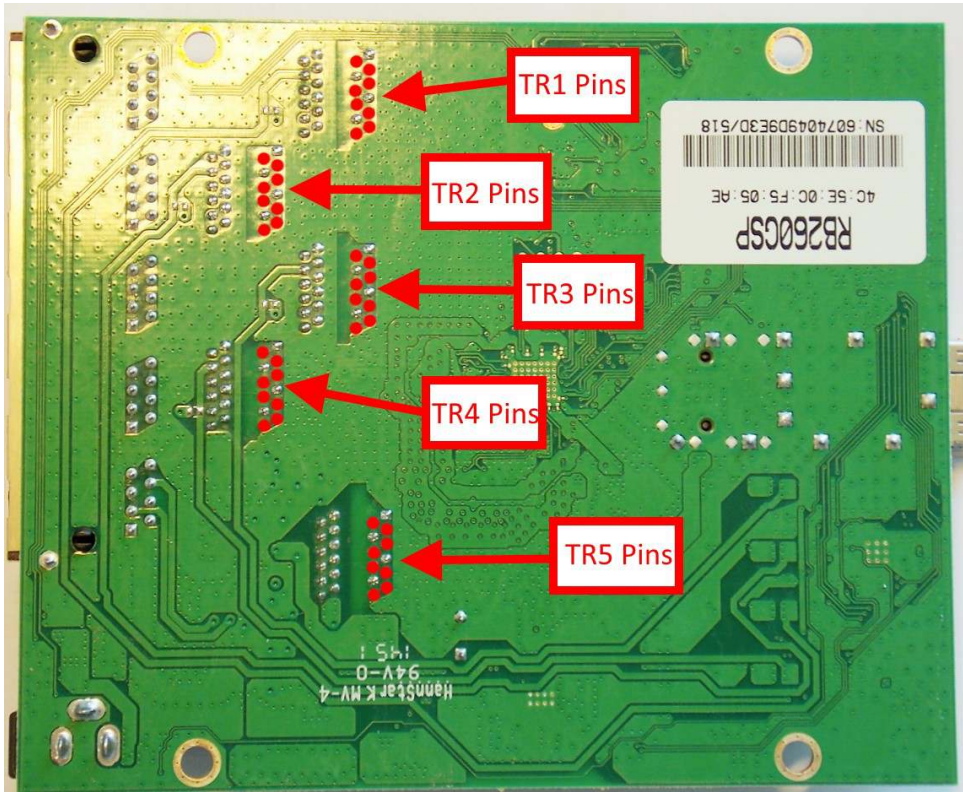

## RBMetal 5SHPn series RouterBoards

---

### Metal 5SHPn



### Disassembling information

1. step: use screw driver to loose N-Male nut



2. step: Removes the internal label

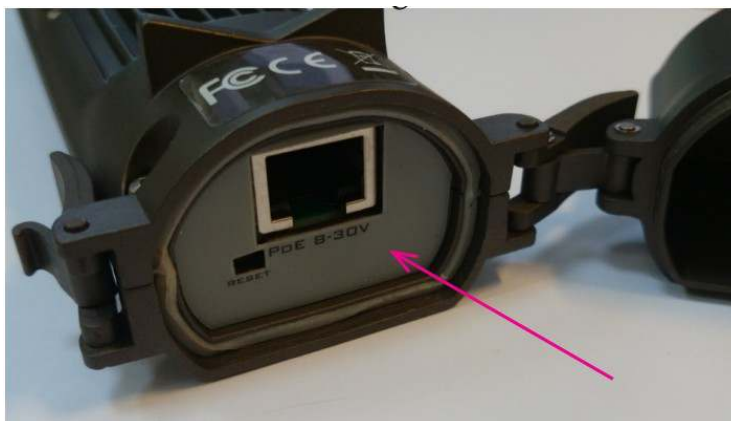

3. step: use TX8 screw driver to loose screws.

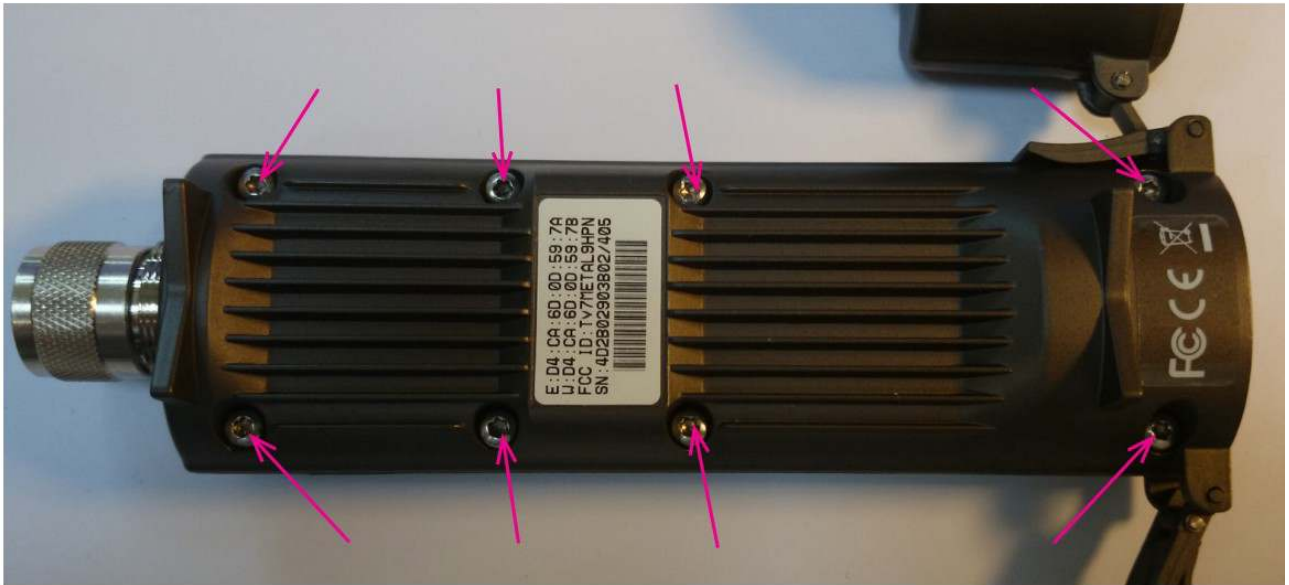

4. Step: take off cover.



## Schottky diode measuring with multimeter in diode mode

Schottky diode reference numbers are D1702; Voltage drop value should be about 0,197V

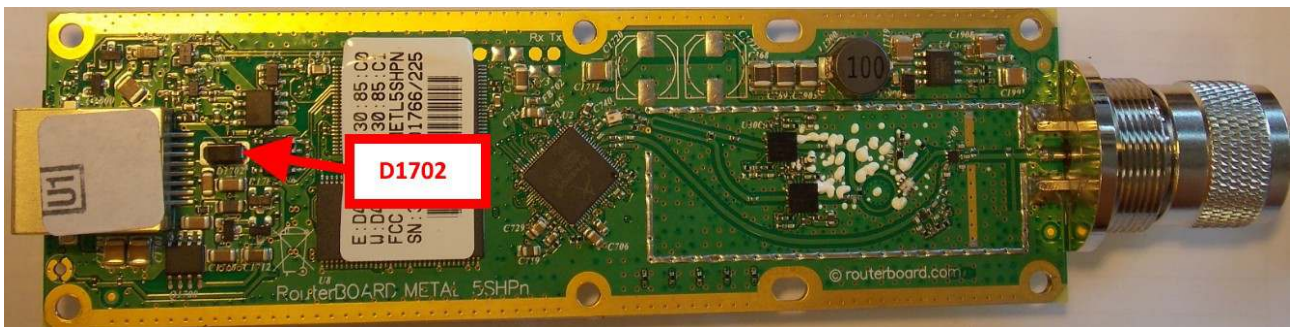

## Voltage drop between diode array pin#1 and Ground.

Check voltage drop between TR1000 Ethernet Transformers on ports Ether1 pins and Ground. Ether Pins are marked with red arrows. It should be in the range from 0,32V to 0,438V

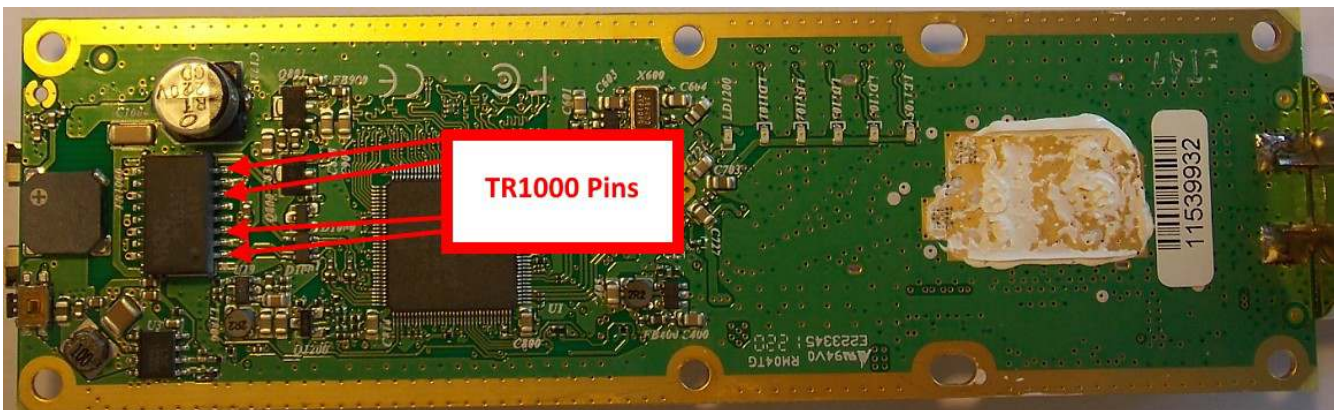



## RBMetal 2SHPn series RouterBoards

---

### Metal 2SHPn



### Disassembling information

1. step: use screw driver to loose N-Male nut



2. step: Removes the internal label

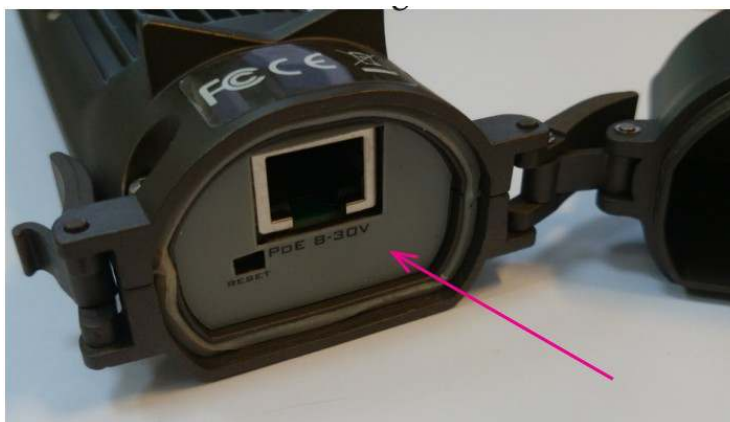

3. step: use TX8 screw driver to loose screws.

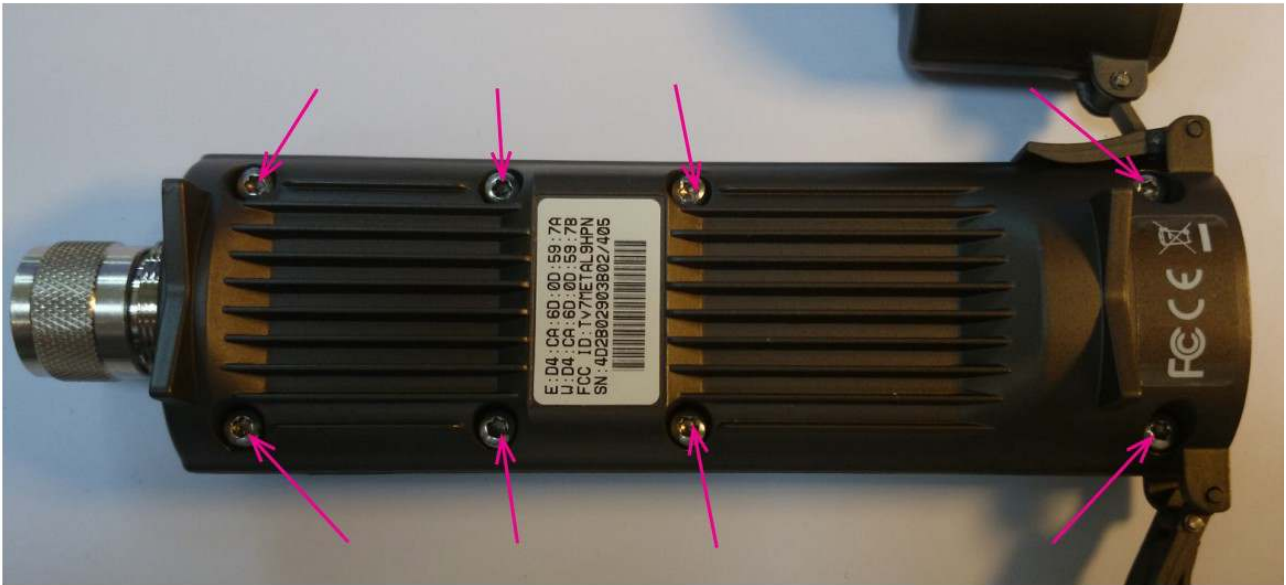

4. Step: take off cover.



## Schottky diode measuring with multimeter in diode mode

Schottky diode reference numbers are D1702; Voltage drop value should be about 0,197V

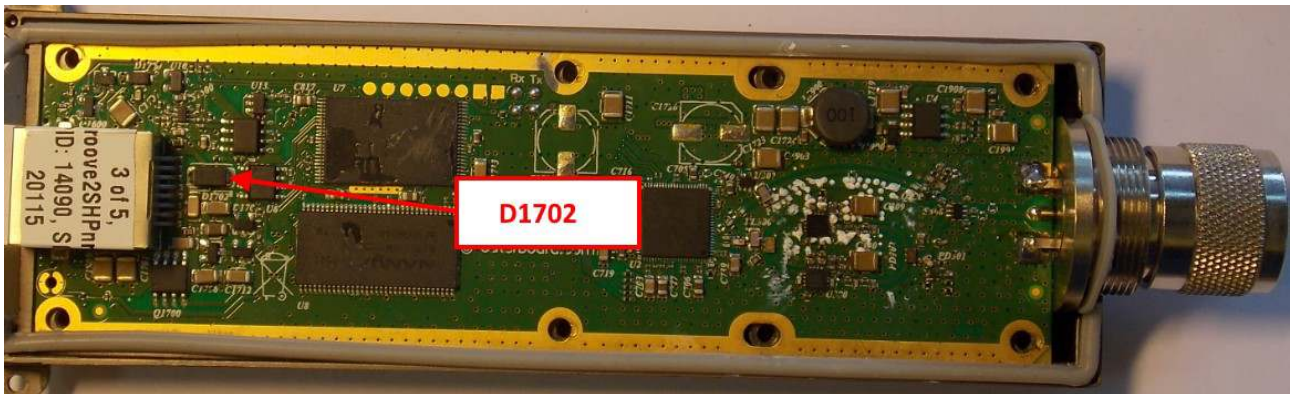

## Voltage drop between diode array pin#1 and Ground.

Check voltage drop between TR1000 Ethernet Transformers on ports Ether1 pins and Ground. Ether Pins are marked with red arrows. It should be in the range from 0,32V to 0,438V



## RBMetal 9HPn series RouterBoards

---

### Metal 9HPn



### Disassembling information

1. step: use screw driver to loose N-Male nut



2. step: Removes the internal label

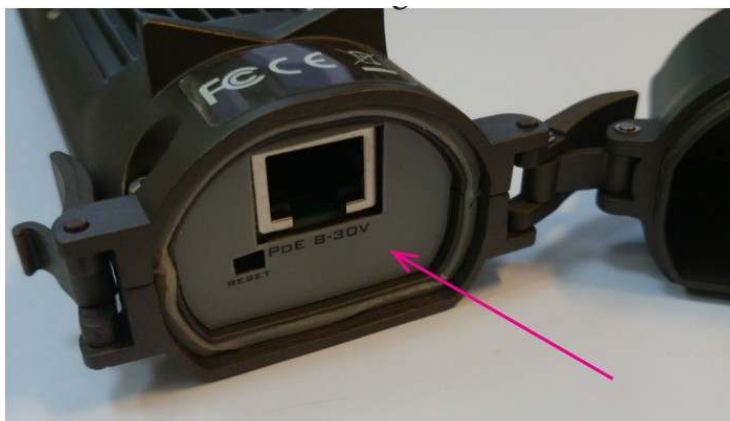

3. step: use TX8 screw driver to loose screws.

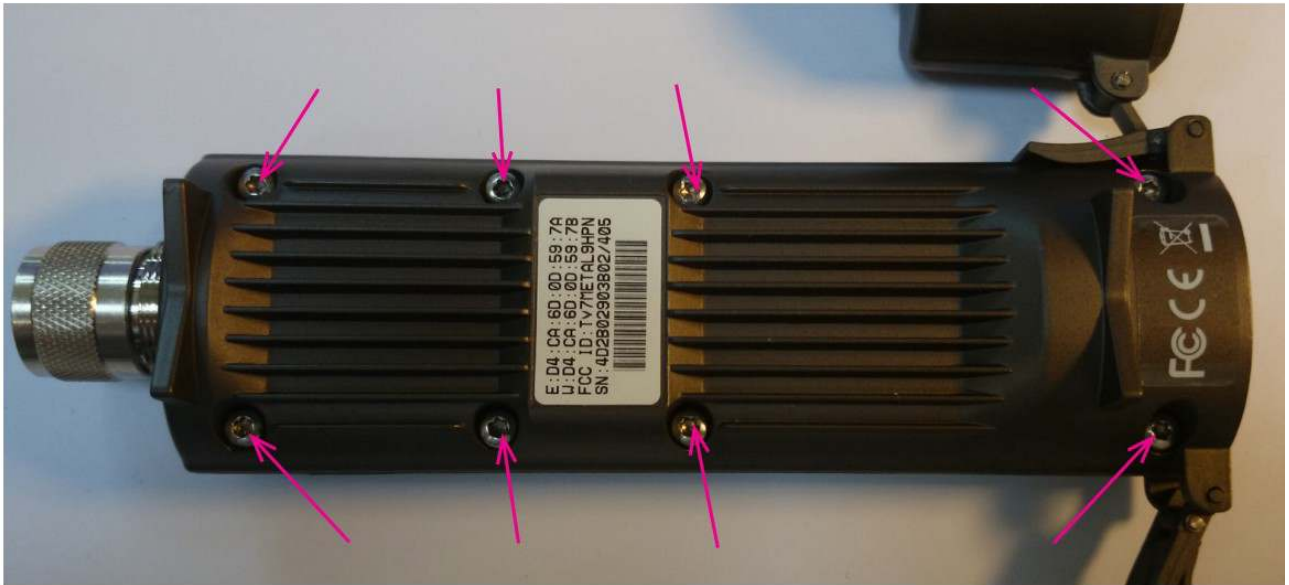

4. Step: take off cover.



## Schottky diode measuring with multimeter in diode mode

Schottky diode reference numbers are D1702; Voltage drop value should be about 0,197V



## Voltage drop between diode array pin#1 and Ground.

Check voltage drop between TR1000 Ethernet Transformers on ports Ether1 pins and Ground. Ether Pins are marked with red arrows. It should be in the range from 0,32V to 0,438V

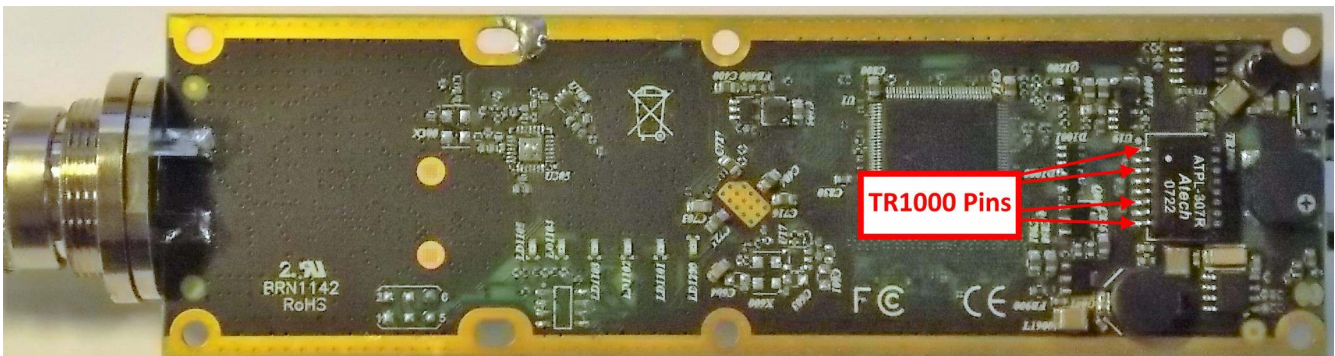

## RBGroove 52HPn series RouterBoards

### Groove 52HPn



### Disassembling information

1. step: use screw driver to loose N-Male nut

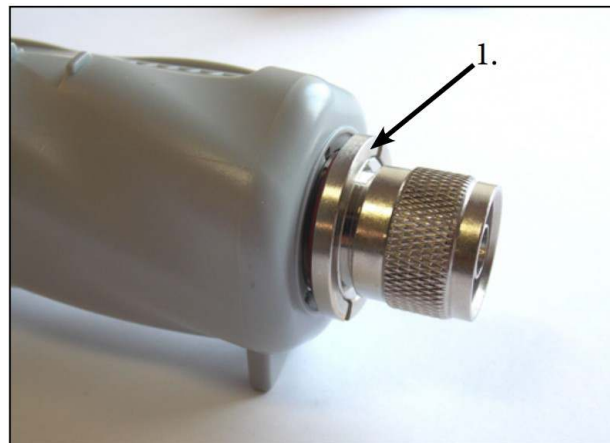

4. Step: take off the board.



## Voltage drop between diode array pin#1 and Ground.

Check voltage drop between TR1000 Ethernet Transformers on ports Ether1 pins and Ground. Ether Pins are marked with red arrows. It should be in the range from 0,32V to 0,438V

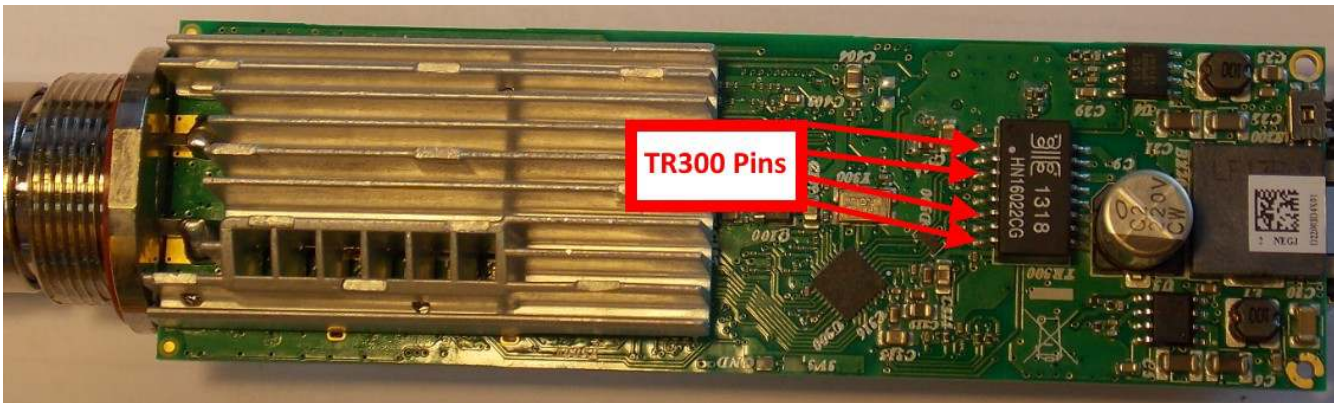

## 75R termination resistors resistance

Resistors marked with red arrows should be 75Ohm +/- 1%





## **RBSXT LTE series RouterBoards**

---

**RBSXT LTE series:**

**SXT LTE**



## Disassembling information

### SXT series disassembling

#### 1. step

Use two “-” screwdrivers. Push screwdrivers in case cavities.

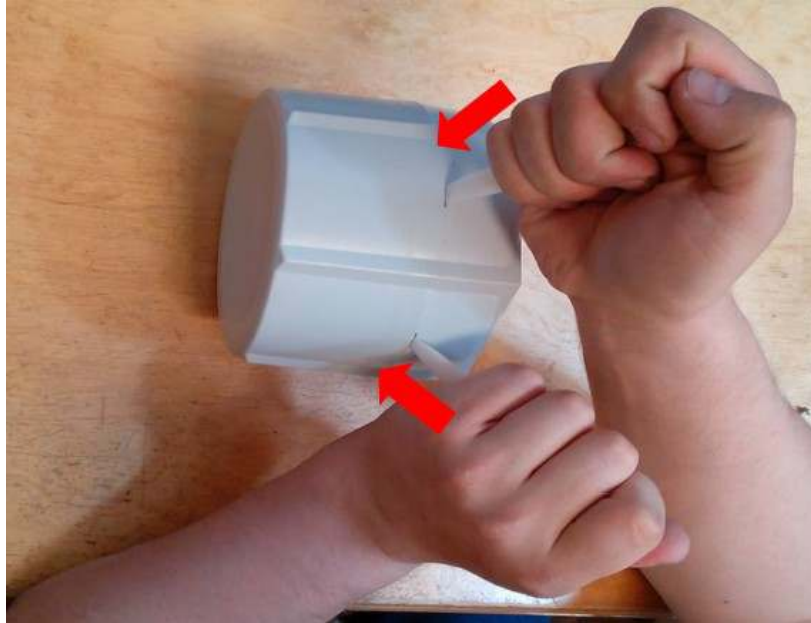

#### 2. step

Rotate screwdriver and pull both case parts.



3. step

Remove rubber bushing

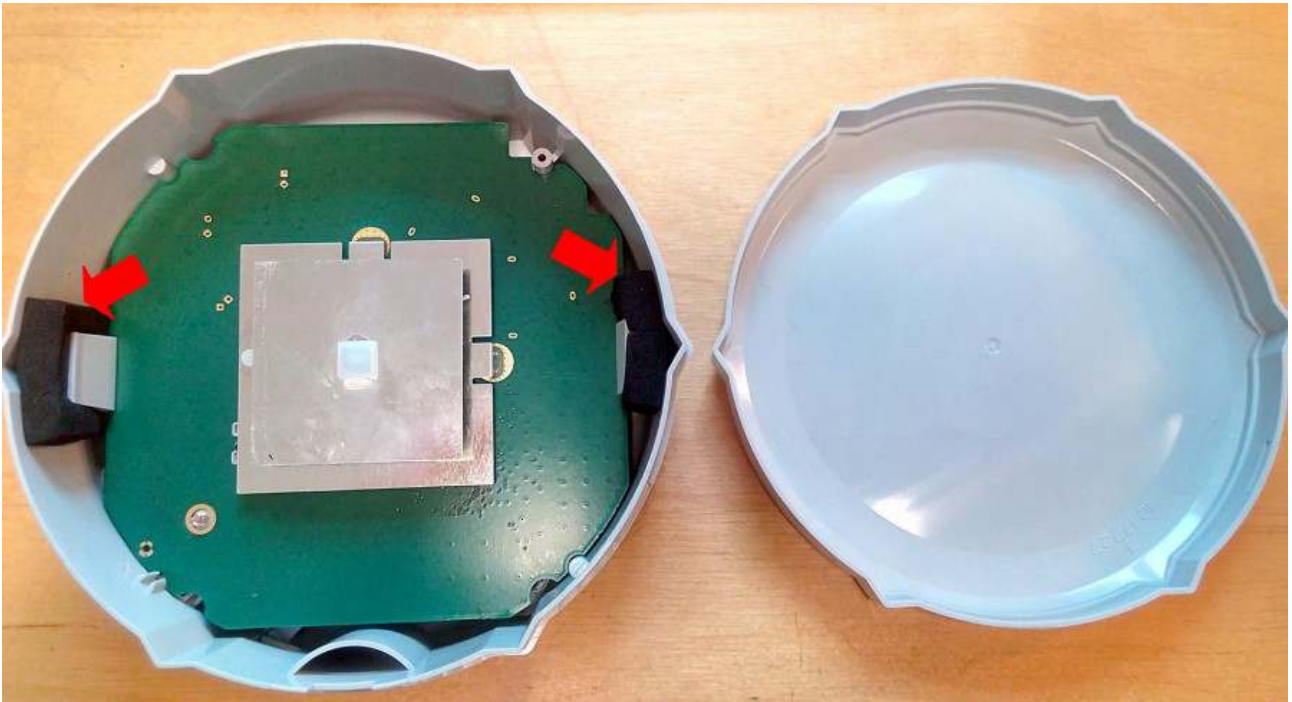

4. step

Push back Plastic PCB holders and take out the board.

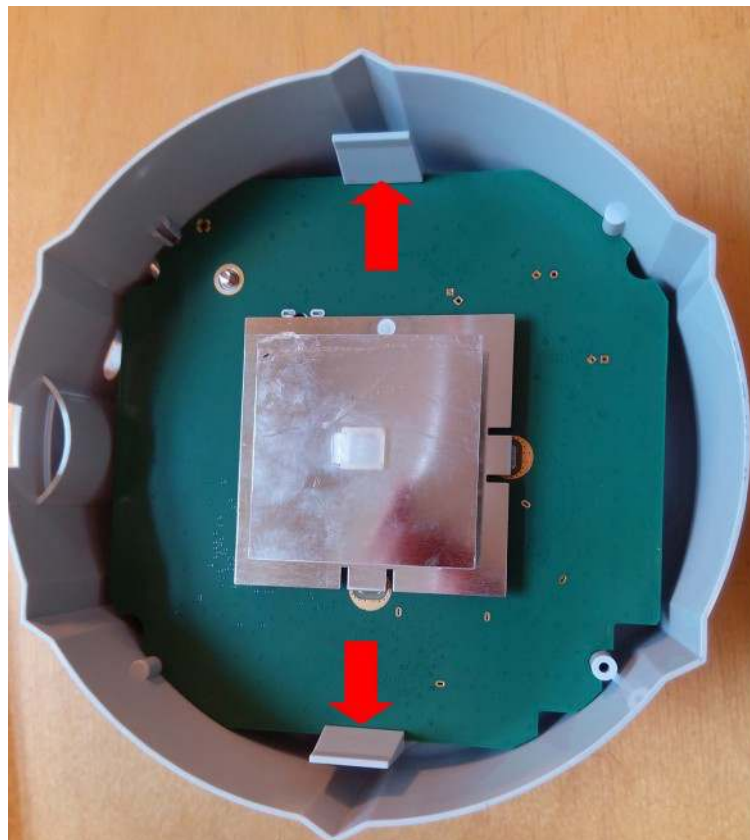

## Schottky diode measuring with multimeter in diode mode

Schottky diode reference number is D300 . Voltage drop value should be about 0,170V

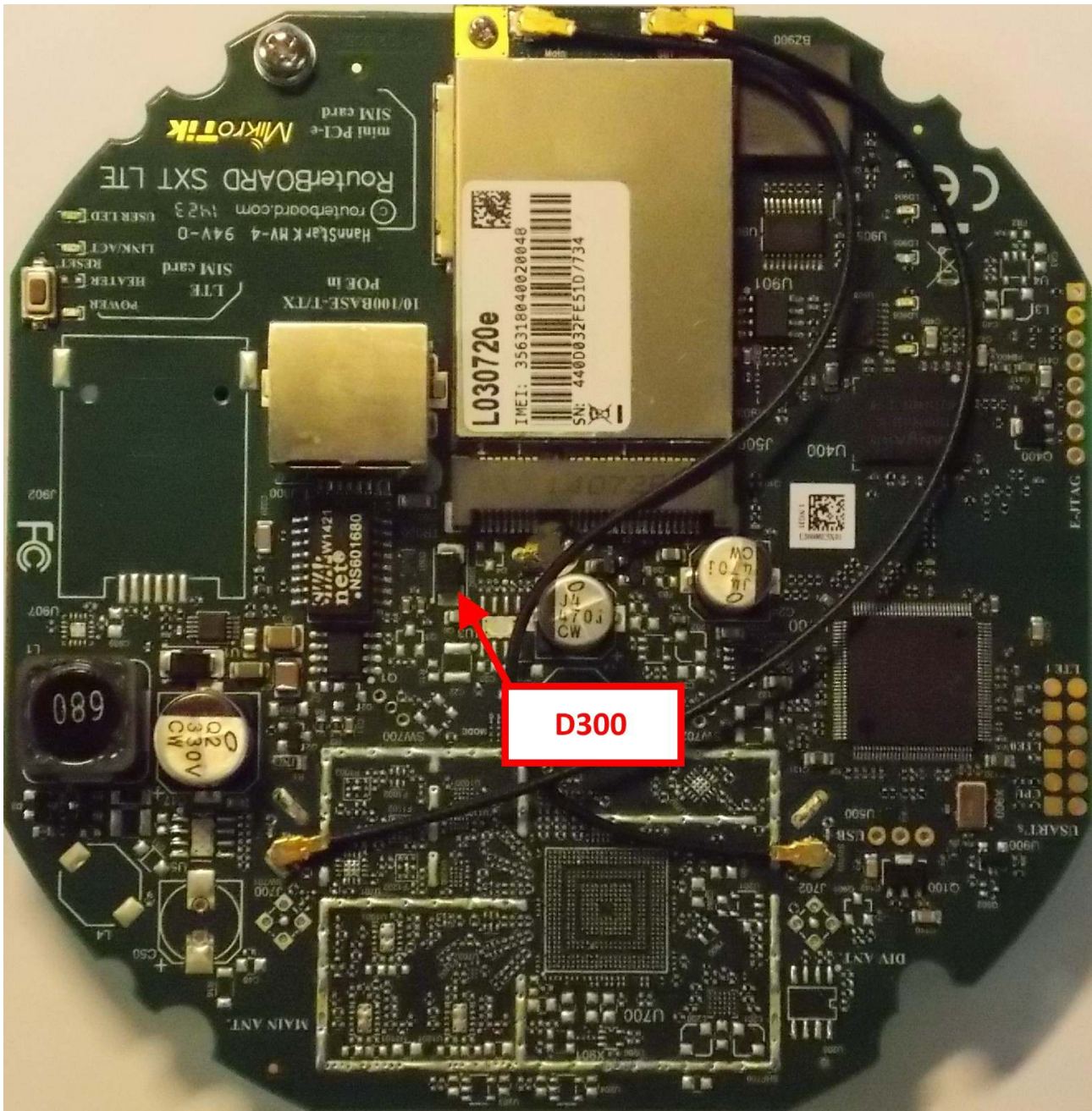

## Voltage drop between diode array pin#1 and Ground.

Check voltage drop between TR300 Ethernet Transformers pins and Ground. Ether Pins are marked with red arrows.

It should be in the range from 0,32V to 0,48V

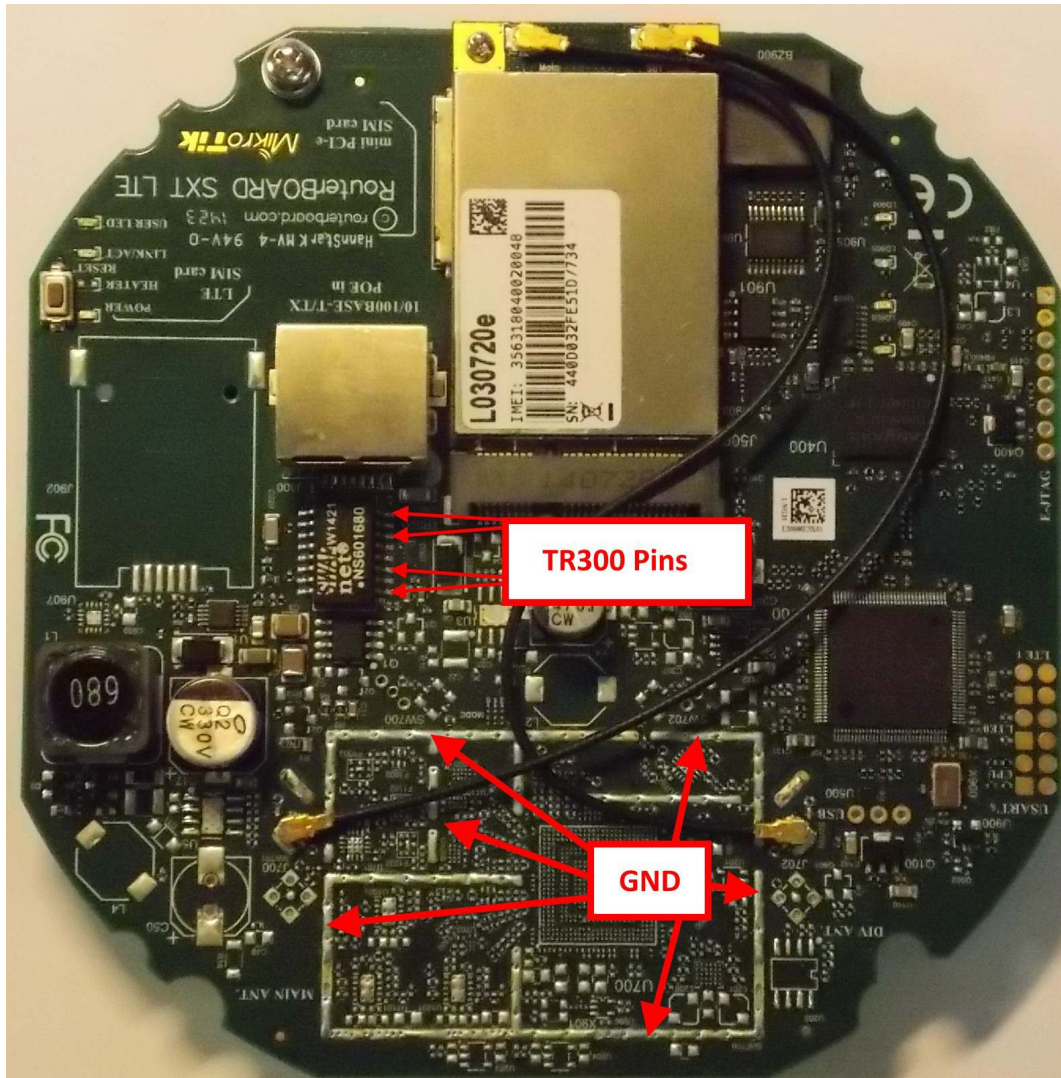

## 75R Termination resistors resistance.

Resistor resistance, marked with red arrow, should be 75 Ohm +/- 1%

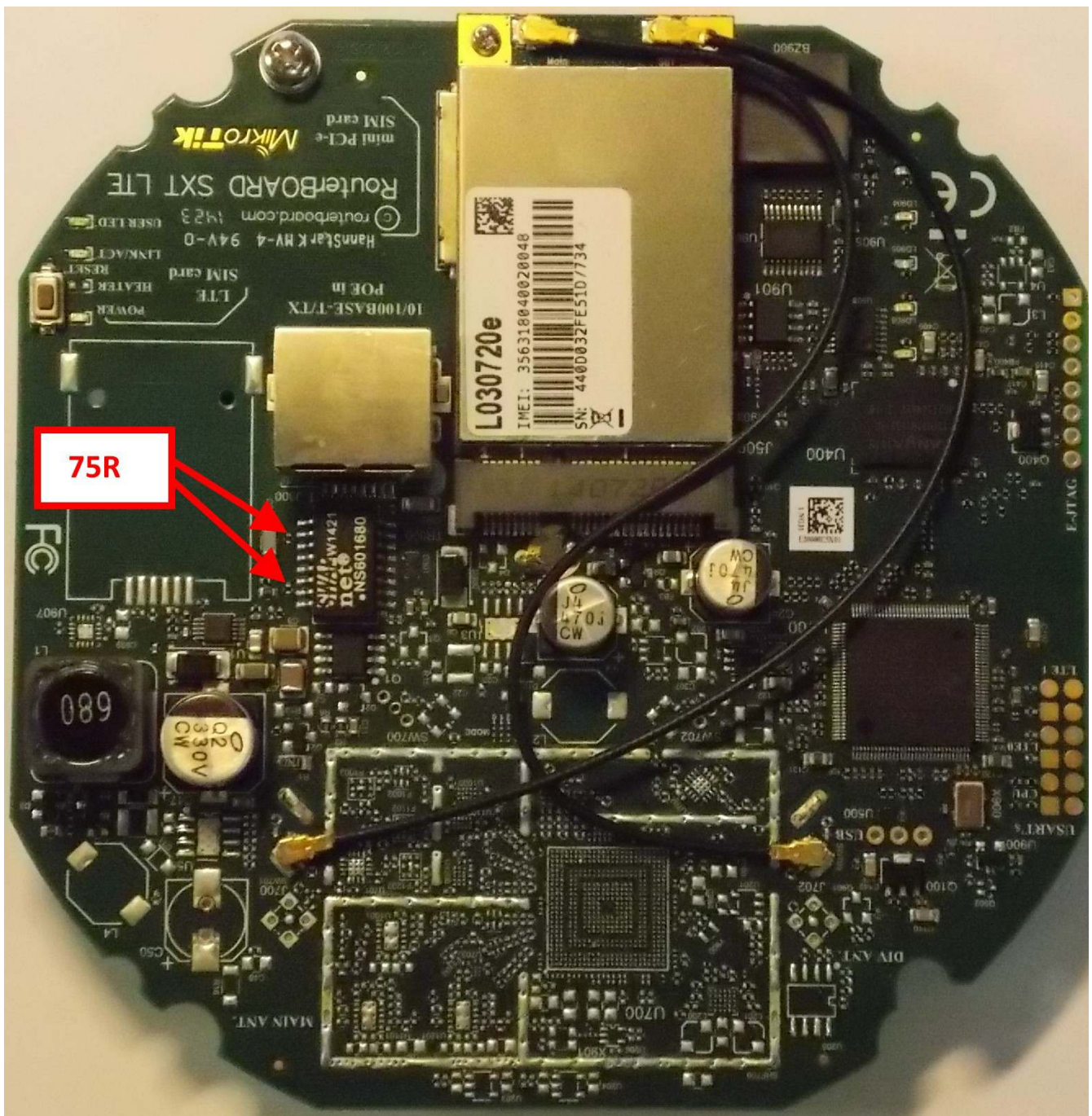

## RB3011 series RouterBoards

---

List of RB3011 series RouterBoards:

### RB3011UiAS-RM



### Disassembling information

#### Rackmount 3011 series RouterBoard

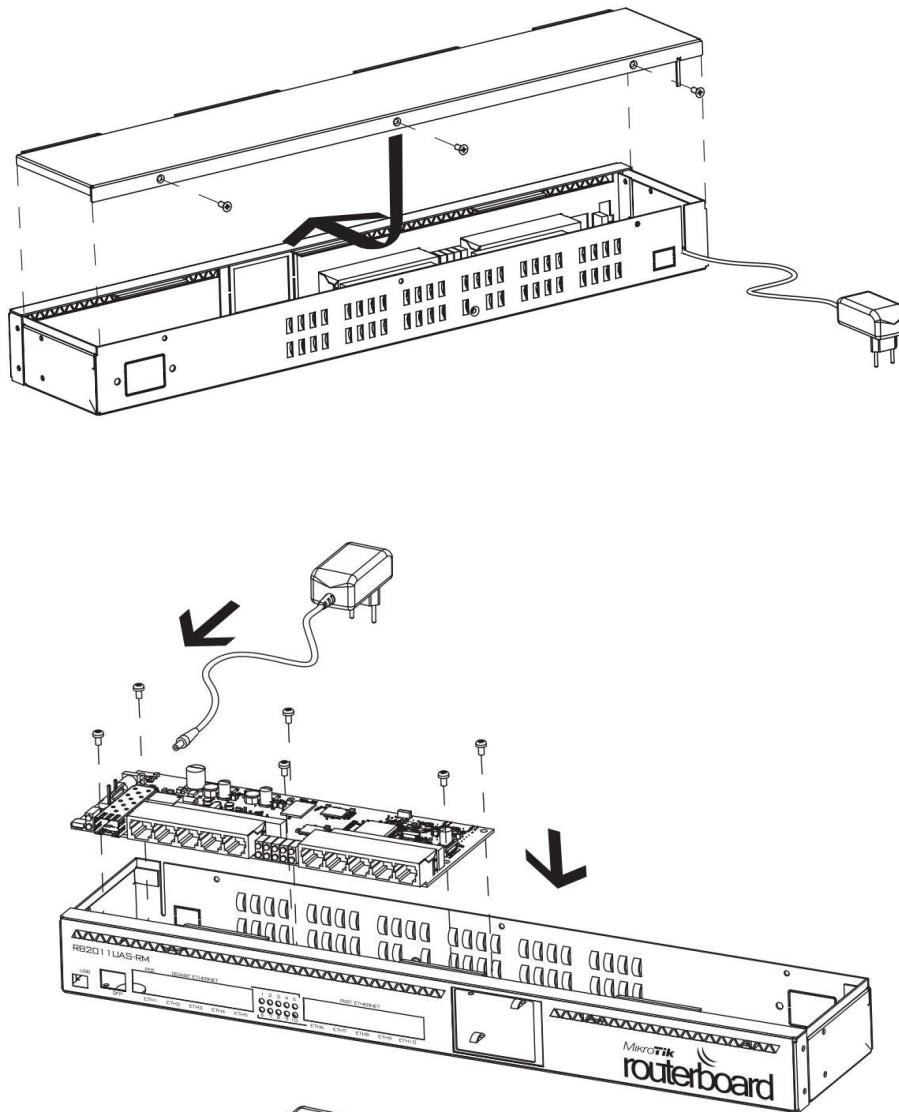

## Schottky diode measuring with multimeter in diode mode

Schottky diode reference numbers are D2, D6; Voltage drop value should be about 0,197V

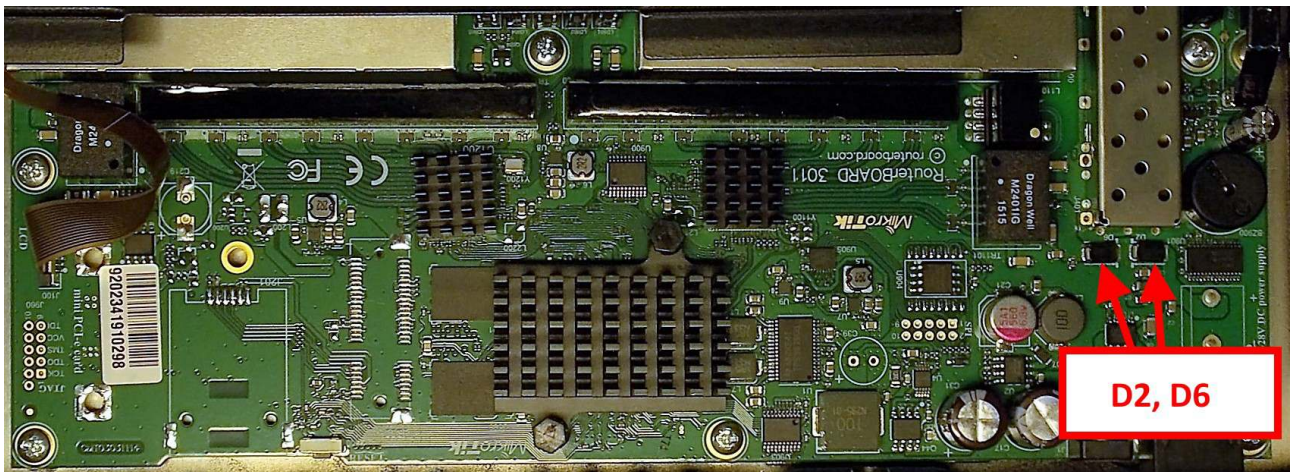

## Voltage drop between diode array pin#1 and Ground.

Check voltage drop between Transformer TR1100, TR1101, TR1200 and TR1202 pins and Ground.

It should be in the range from 0,32V to 0,438V

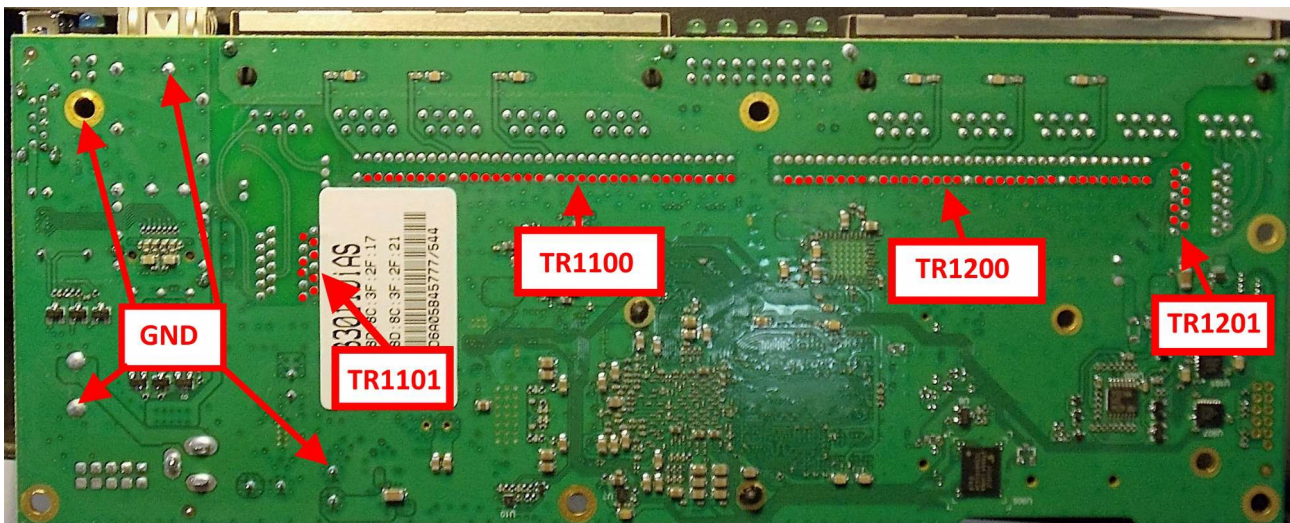



## Termination resistors resistance

Resistors marked with red arrows resistance should be 75Ohm +/- 1%

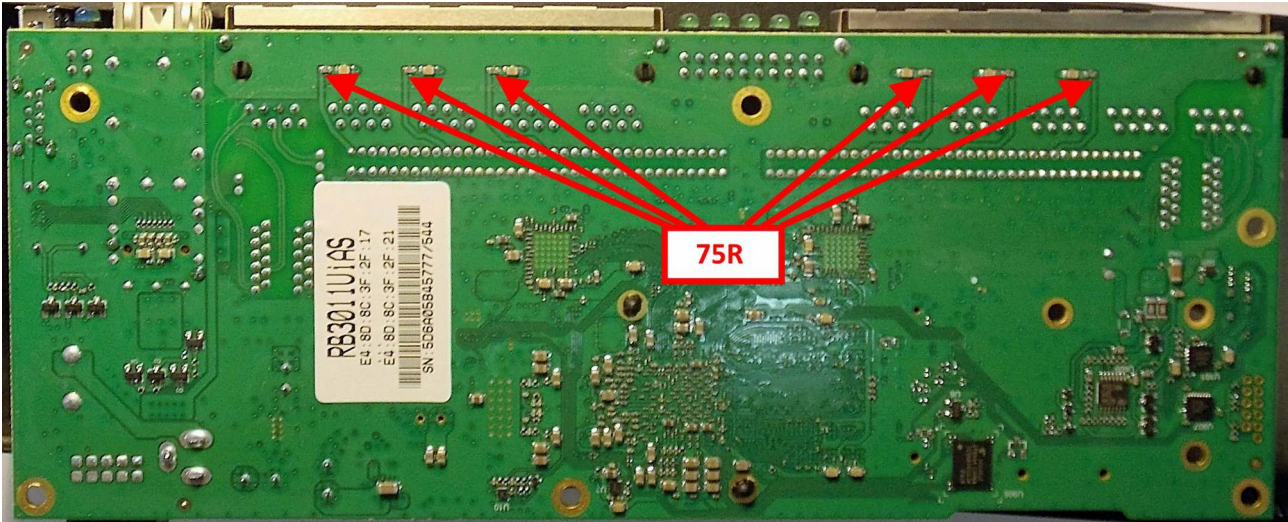

On ports Ether2 – Ether9 You can take patch cord and plug it into the routerboard, and then measure resistance of termination resistors.

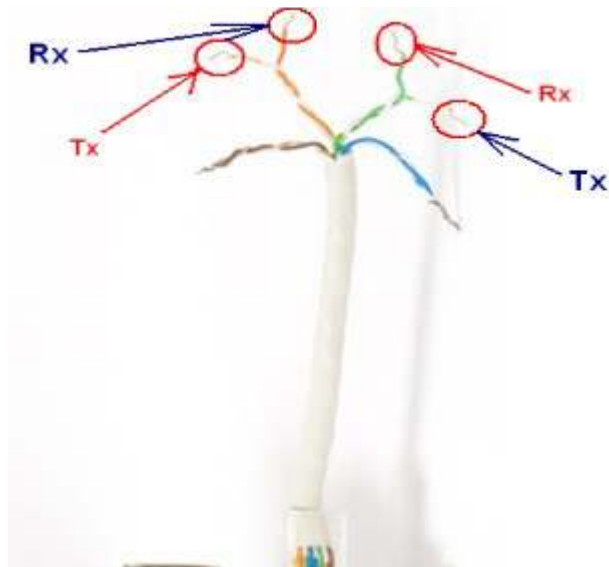

Resistance value between Rx and Tx line must be 150 Ohm +/-4%.

If resistance value is smaller or higher then Tx/Rx line was damaged by high voltage surge.

## **RBOmniTIK UPA-5HnD series RouterBoards**

---

**OmniTIK U-5HnD**

**OmniTIK UPA-5HnD**



# OmniTIK UPA-5HnD disassembling information

## 1. step

Remove the screw stickers and unscrew the case base from the board holder with torque screwdriver T8



## 2. step

Remove the case base from the board holder



## Schottky diode measuring with multimeter in diode mode

Schottky diode reference numbers are D4, D802, D804, D806, D808. Voltage drop value should be about 0,350V

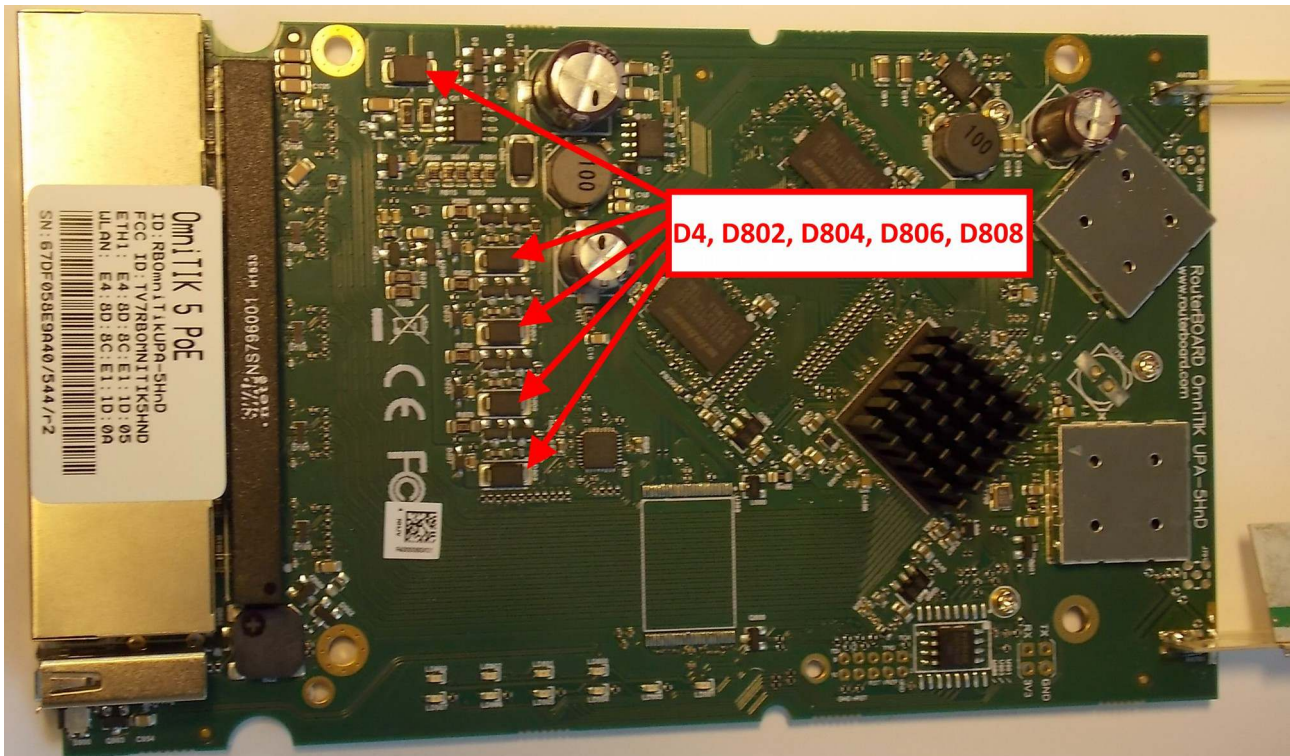

## Voltage drop between diode array pin#1 and Ground.

Check voltage drop between TR1, Transformers pins and Ground. Ether Pins are marked with red. It should be in the range from 0,32V to 0,589V

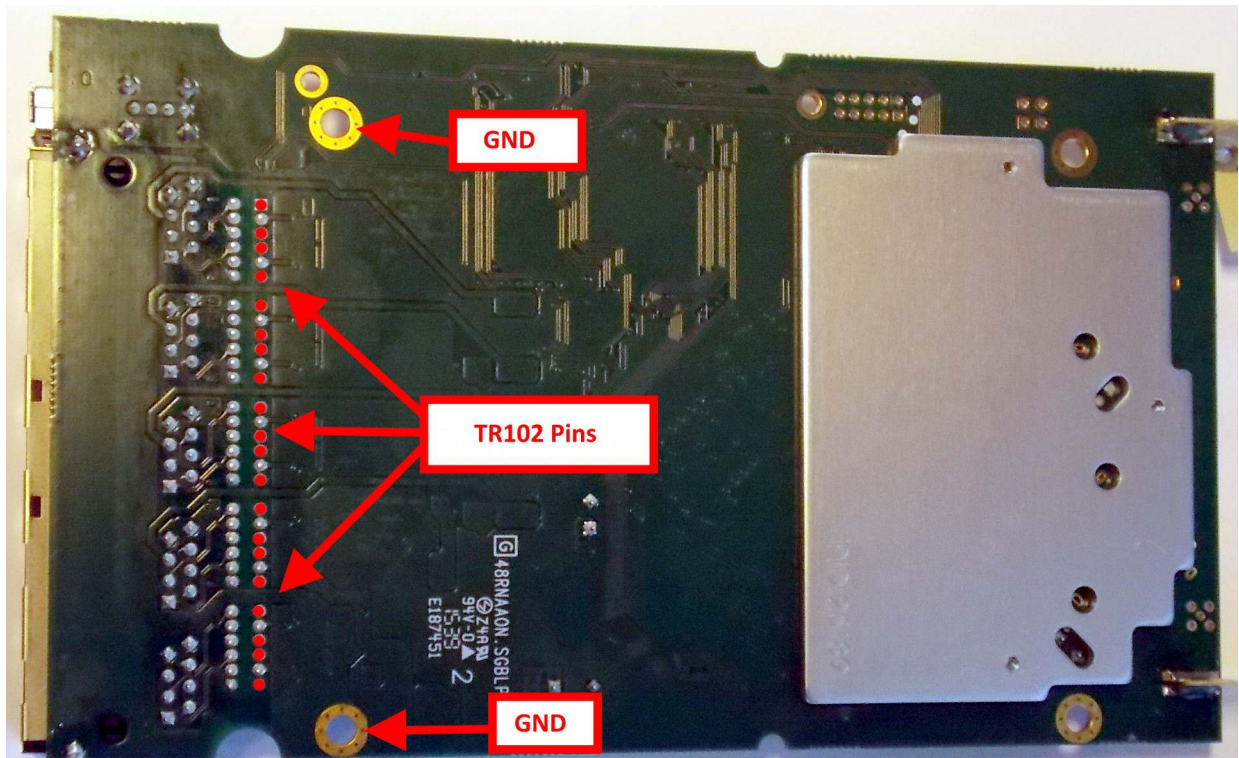

## 75R Termination resistors resistance.

Resistor resistance, marked with red arrow, should be 75 Ohm +/- 1%

